

Random orbital sander - 3 601 C7B 110 - ROS65VC

www.powertools-aftersaleservice.com



BOSCH

Item	Part Number	Description	Illustration	Price	Quantity	Price Group
1	2 605 105 964	Housing Section BLUE	1	-,-	1	35
2	2 604 220 744	Field 110-127V	1	-,-	1	36
3	2 604 011 435	Armature 127V	1	-,-	1	43
3/13	2 600 905 051	Deep-Groove Ball Bearing 7x19x6	1	-,-	1	21
3/60	2 606 610 076	Fan	1	-,-	1	15
4	2 607 200 689	Switch	1	-,-	1	27
5	2 604 460 240	Power supply cord USA/CAN/ SMA 4,15m 2 x 0,82mm SJ 18/2	1	-,-	1	31
6	2 600 703 070	Grommet Ø7,3-Ø8,6x120 MM	1	-,-	1	12
8	2 601 111 614	Nameplate	1	-,-	1	16
9	2 601 111 853	Manufacturer's nameplate ROS65VC	1	-,-	1	13
14	2 600 905 034	Deep-Groove Ball Bearing	1	-,-	1	25
16	2 604 337 003	Brush Holder	1	-,-	2	12
19	2 603 490 017	Torx Oval-Head Screw 3x10	1	-,-	1	10
20	2 601 111 477	Reference Plate	1	-,-	1	13
21	2 600 283 022	Suction Hood	1	-,-	1	33
22	2 601 328 091	Suction Piece	1	-,-	1	21
23	2 601 328 090	Suction Piece	1	-,-	1	20
24	2 603 435 043	Special Screw 3x8 MM	1	-,-	2	11
25	2 603 435 096	Torx Oval-Head Screw M3x10	1	-,-	3	10
30	2 600 100 041	Plain Washer DIN 315-M8-GT-C	1	-,-	1	11
33	2 600 206 028	Friction Ring	1	-,-	1	23
34	2 608 601 106	Backing Pad Ø150	1	-,-	1	34
35	2 910 130 244	Hex Socket Head Cap Screw DIN 7984-M8x25-8.8	1	-,-	1	11
37	2 603 435 086	Tapping Screw	1	-,-	2	10
40	2 603 435 042	Thread-forming tap. Screw	1	-,-	4	11
41	2 603 490 017	Torx Oval-Head Screw 3x10	1	-,-	4	10
42	2 604 448 368	Connecting Cable	1	-,-	2	12
43	2 603 203 041	Damping Element	1	-,-	8	11
44	1 607 233 440	Speed governor 100-120V	1	-,-	1	38
45	2 915 121 006	Square Nut DIN 562-M6-04	1	-,-	1	10
46	2 603 490 023	Torx Oval-Head Screw 4x20	1	-,-	5	10
47	2 605 500 208	Housing Cover	1	-,-	1	24

Item	Part Number	Description	Illustration	Price	Quantity	Price Group
48	2 603 490 022	Torx Oval-Head Screw 4x16	1	-,-	2	10
49	1 907 950 006	Offset Screwdriver DIN 911-SW5 BLACK	1	-,-	1	15
655	2 605 411 234	Dust Chamber	1	-,-	1	44
656	2 602 026 175	Auxiliary Handle BLACK	1	-,-	1	27
811	1 607 014 117	Carbon Brush	1	-,-	1	22
826	2 606 610 903	Fan	1	-,-	1	39
836	2 605 105 966	Motor Housing BLUE	1	-,-	1	31

Product information Random orbital sander - 3 601 C7B 110 - ROS65VC

Product No	3 601 C7B 110
Description	251.372; Random orbital sander
DIN-Text	
ID_Text_Ext	0
Trading_Description	ROS65VC
Voltage_1	120 V
ID_Country_Product	USA

Illustration - Type E

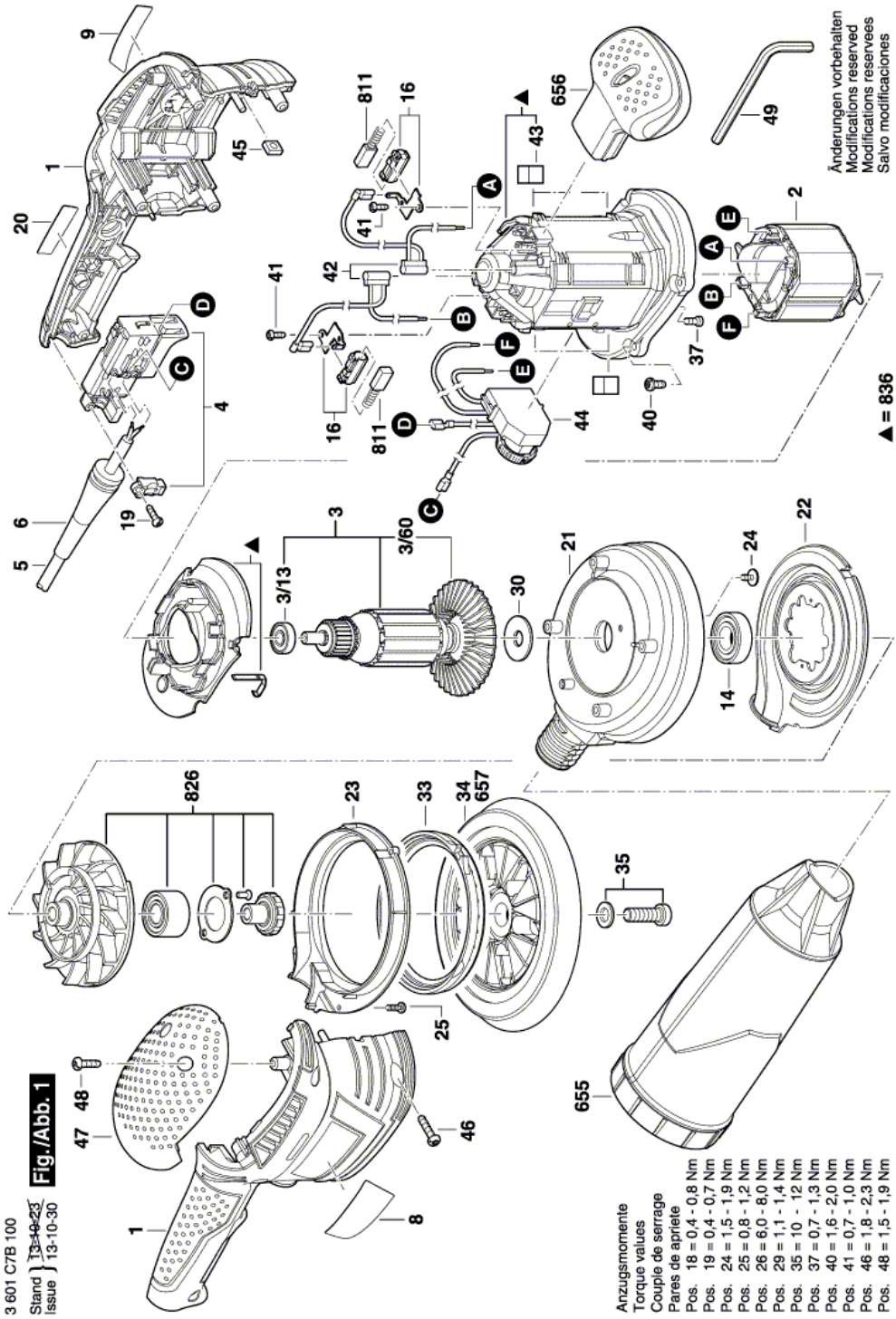

Information subject to change without further notice.