







NOTES:

-  TORQUE TO 45-75 IN/LBS
-  TORQUE TO 20-25 FT/LBS
-  TORQUE TO 15-20 FT/LBS
-  TORQUE TO 55-100 IN/LBS
-  TORQUE TO 35-65 IN/LBS
-  TORQUE TO 45-60 IN/LBS

# 755H Pump Assembly

## Notes:

- 1 Torque to 25-27 lb-ft.
- 2 Torque to 14-16 lb-ft.
- 3 Torque to 9-12 lb-ft.
- 4 Torque to 8 lb-ft.
- 5 Torque to 5 lb-ft.

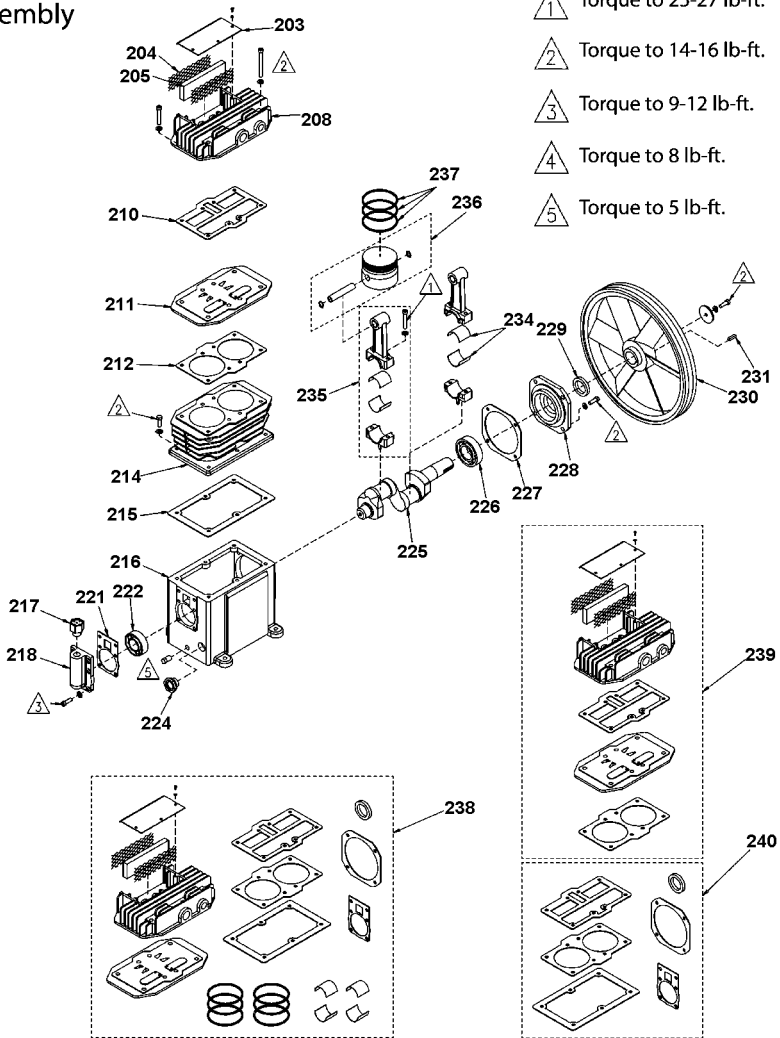

## Parts List for PXXM601 Type 0

Item Number	Part Number	Description	Qty Required
1	5140169-33	BELT GUARD	1
2	5140169-18	FASTENER	1
3	5140169-34	SCREW	1
4	5140169-35	BELT GUARD	1
5	000000-00	No Longer Available	1
6	5140169-36	PULLEY	1
7	5140169-37	BELT	1
8	5140169-38	MOTOR	1
9	SSF-3039-ZN	SCREW .313-18X.750 H	4
10	SS-656-CD	NUT .313-18 UNC HEX	4
11	5140169-39	CORD	1
12	5140169-40	BUSHING	1
12	5140169-41	O-RING	1
12	N286039	DRAIN VALVE	1
12	5140169-42	BUSHING	1
13	000000-00	No Longer Available	4
14	5140121-17	PUMP ASSEMBLY	1
15	5140169-43	CHECK VALVE	1
16	5140169-44	PRESSURE RELIEF TUBE	1
17	5140169-45	OUTLET TUBE	1
18	5140119-17	NUT	1
19	5140119-16	ADAPTER	1
20	SSP-7811	ASSY NUT SLEEVE 1/4	1
21	5140169-46	PRESSURE SWITCH	1
22	5140169-22	SAFETY VALVE	1
23	5140169-12	PRESSURE GAUGE	1
24	000000-00	No Longer Available	1

## Parts List for PXXM601 Type 0

Item Number	Part Number	Description	Qty Required
26	5140169-47	ISOLATOR	1
203	5140119-24	COVER	1
204	5140119-25	SCREEN	2
205	5140119-26	FILTER	1
208	5140121-18	HEAD ASSEMBLY	1
210	5140119-28	HEAD GASKET	1
211	5140119-29	VALVE PLATE ASSEMBLY	1
212	5140119-30	GASKET	1
214	5140119-31	CYLINDER	1
215	5140119-32	GASKET	1
216	5140119-33	CRANK CASE	1
217	5140119-34	BREATHER	1
218	5140150-56	CAP ASSEMBLY	1
221	5140119-36	GASKET	1
222	5140119-37	BEARING	1
224	5140119-38	OIL SIGHT GLASS	1
225	5140121-19	CRANKSHAFT	1
226	5140119-40	BEARING	1
227	5140119-41	GASKET	1
228	5140119-42	CARRIER	1
229	5140119-43	OIL SEAL	1
230	5140119-44	FLYWHEEL	1
231	5140119-45	KEY	1
234	000000-00	No Longer Available	2
235	5140121-20	ROD	2
236	5140119-48	PISTON ASSY.	2
237	5140119-49	RING SET	2

## Parts List for PXXM601 Type 0

Item Number	Part Number	Description	Qty Required
238	5140121-21	OVERHAUL KIT	1
239	5140121-22	HEAD/VALVE ASSY.	1
240	5140119-52	GASKET SET	1