

RYOBI 18 VOLT, 1/2 in. 2-SPEED DRILL DRIVER - MODEL NUMBER P271

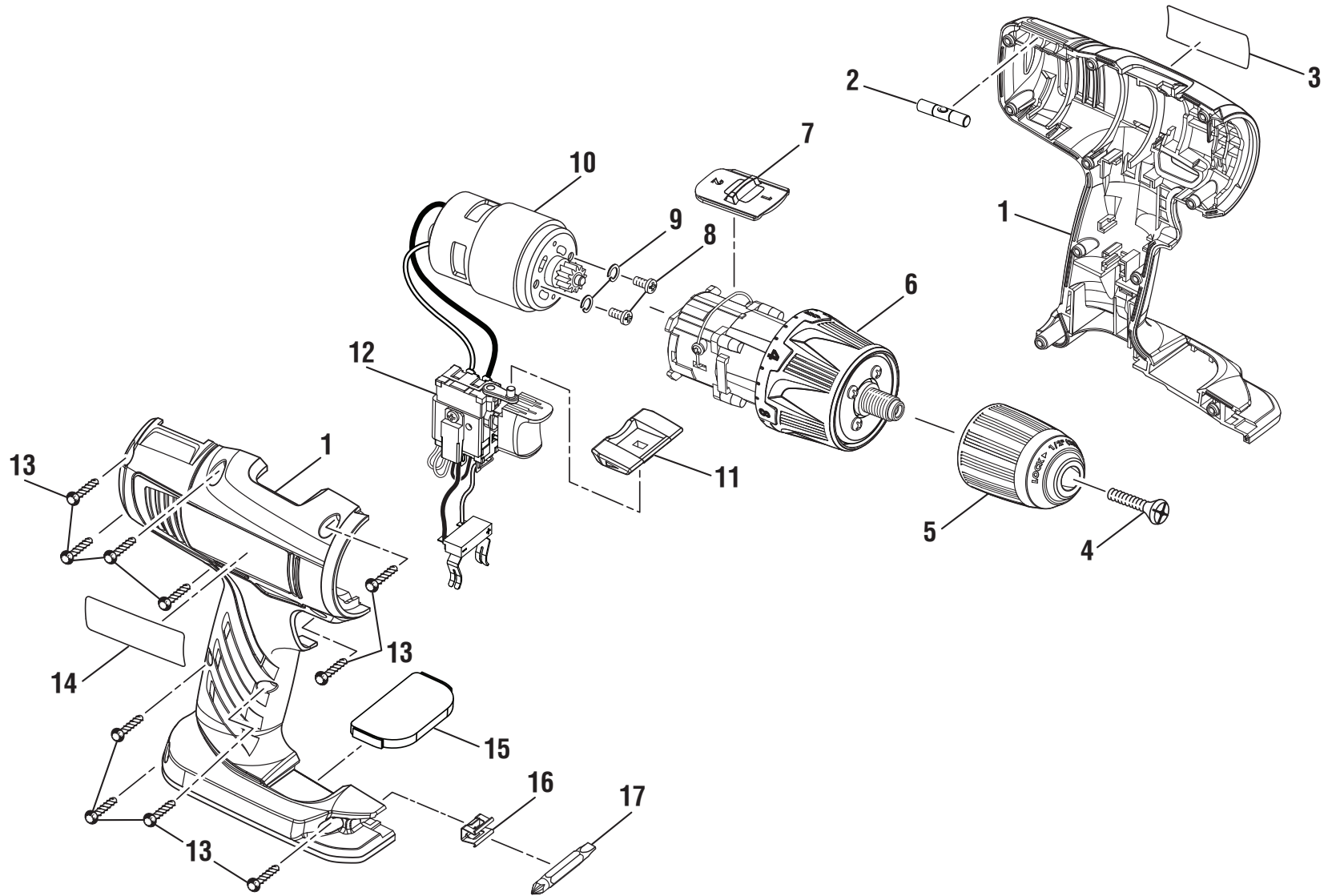

RYOBI 18 VOLT, 1/2 in. 2-SPEED DRILL DRIVER – MODEL NUMBER P271

The model number will be found on a label attached to the motor housing. Always mention the model number in all correspondence regarding your **18 VOLT, 1/2 in. 2-SPEED DRILL DRIVER** or when ordering parts.

PARTS LIST

KEY NO.	PART NUMBER	DESCRIPTION	QTY	KEY NO.	PART NUMBER	DESCRIPTION	QTY
1	201024004	Housing Assembly	1	12	270013028	Switch Assembly	1
2	3000909	Level Assembly	1	13	660031012	Screw (M3.5 x 14 mm)	10
3	940114178	Logo Label	1	14	940488534	Data Label	1
4	6613402	Screw (M6 x 27 mm)	1	15	303001015	Magnet Assembly	1
5	670794002	Chuck	1	16	630206007	Bit Clip (0.4 mm)	1
6	201025003	Clutch Cap & Gear Train Assembly	1	17	6782045	Double Bit	1
7	343318001	Gear Change Knob	1	NOT SHOWN:			
8	6621205	Screw (M4 x 8 mm)	2	988000929	Operator's Manual	1	
9	670030004	Spring Washer (OD 7.2 x ID 4.1 x 1 mm)	2	3-5-13			
10	230079021	Motor Assembly	1	(REV:02)			
11	343319001	Forward/Reverse Selector	1				