

MXE 1002

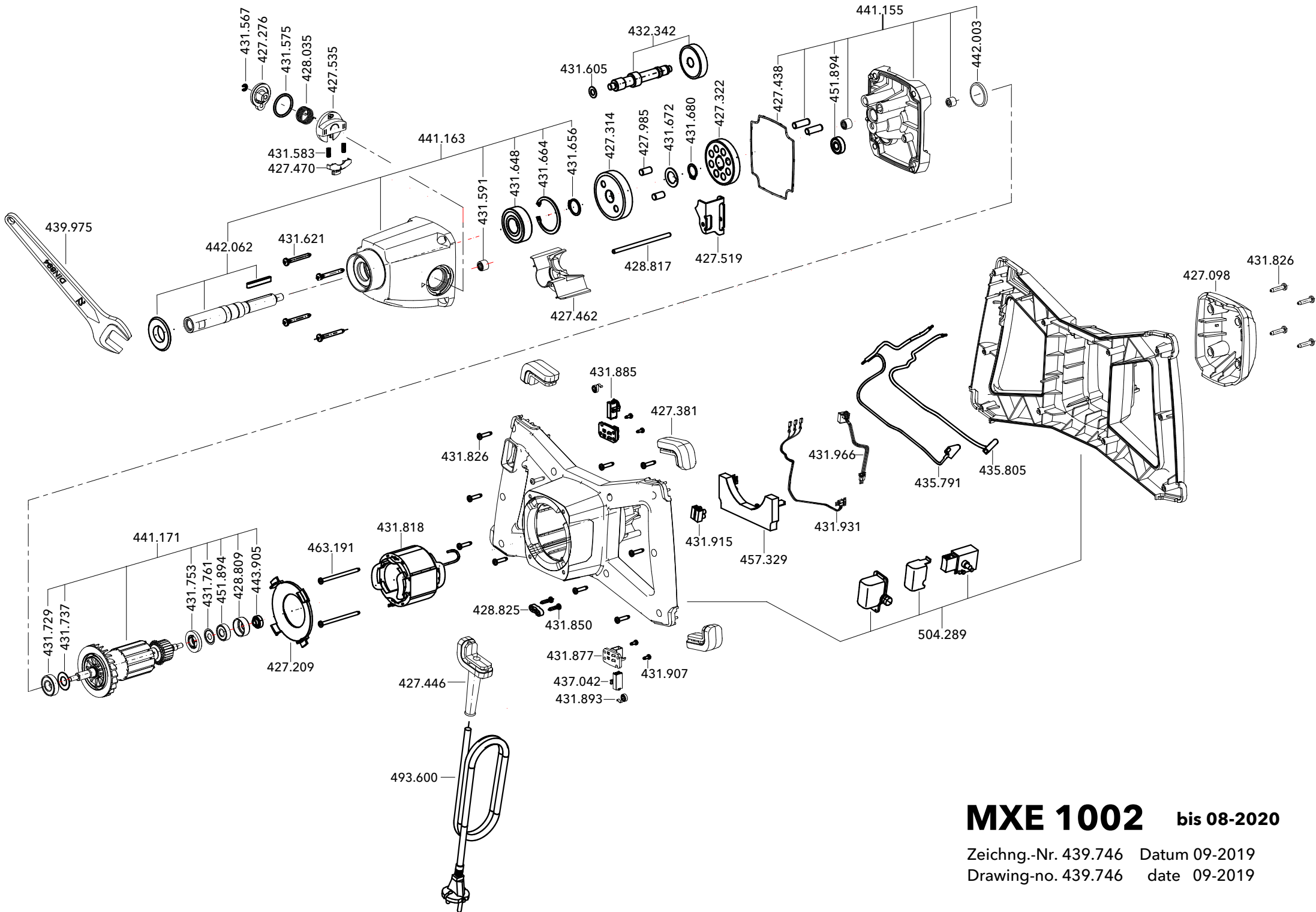

MXE 1002 bis 08-2020

Zeichng.-Nr. 439.746 Datum 09-2019
 Drawing-no. 439.746 date 09-2019