

3 601 E12 010
Issue }
Stand } 12-09-27

Fig./Abb. 1

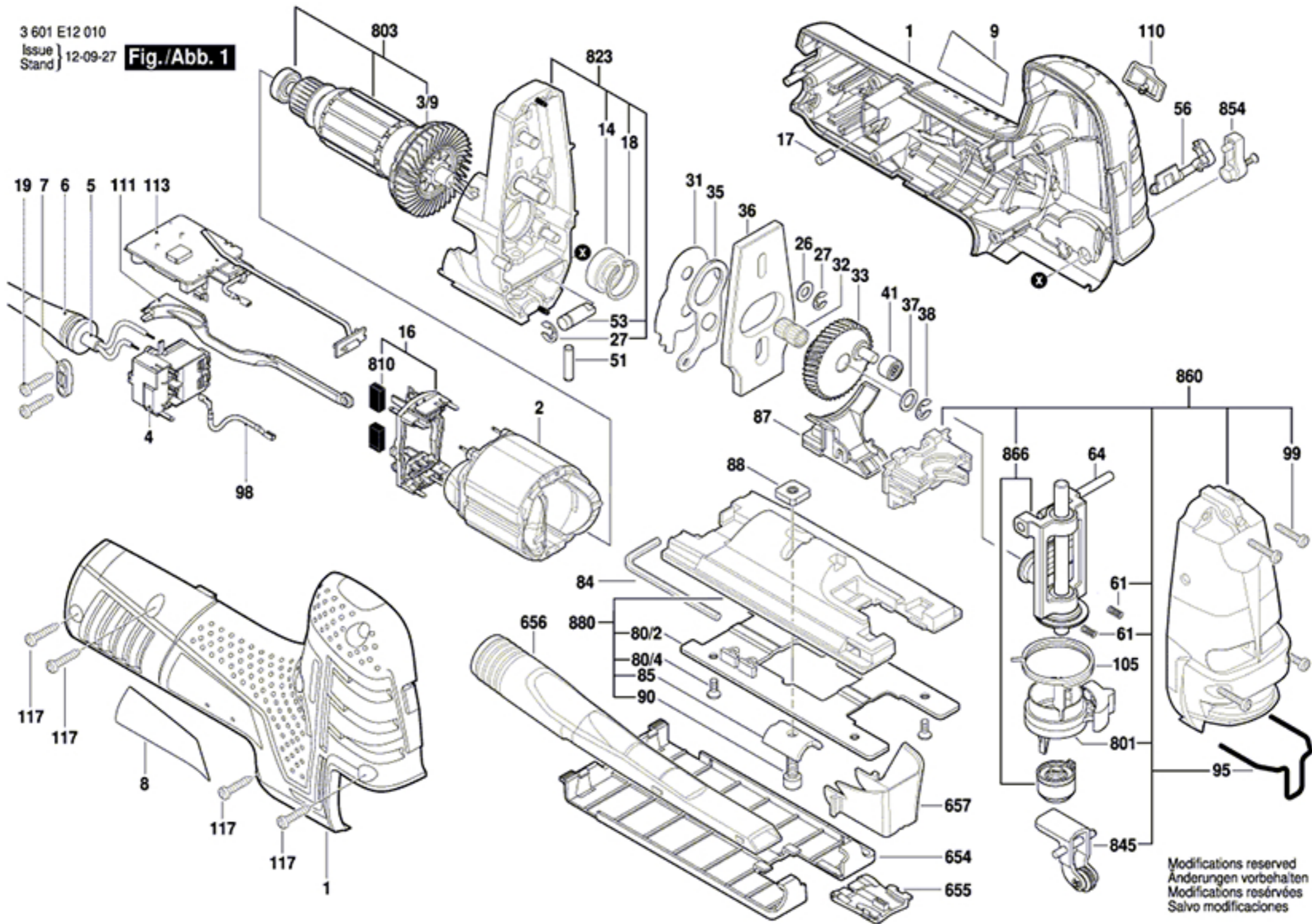

Modifications reserved
Änderungen vorbehalten
Modifications réservées
Salvo modificaciones