

3 601 E13 010
Issue
Stand } 11-03-09

Fig./Abb. 1

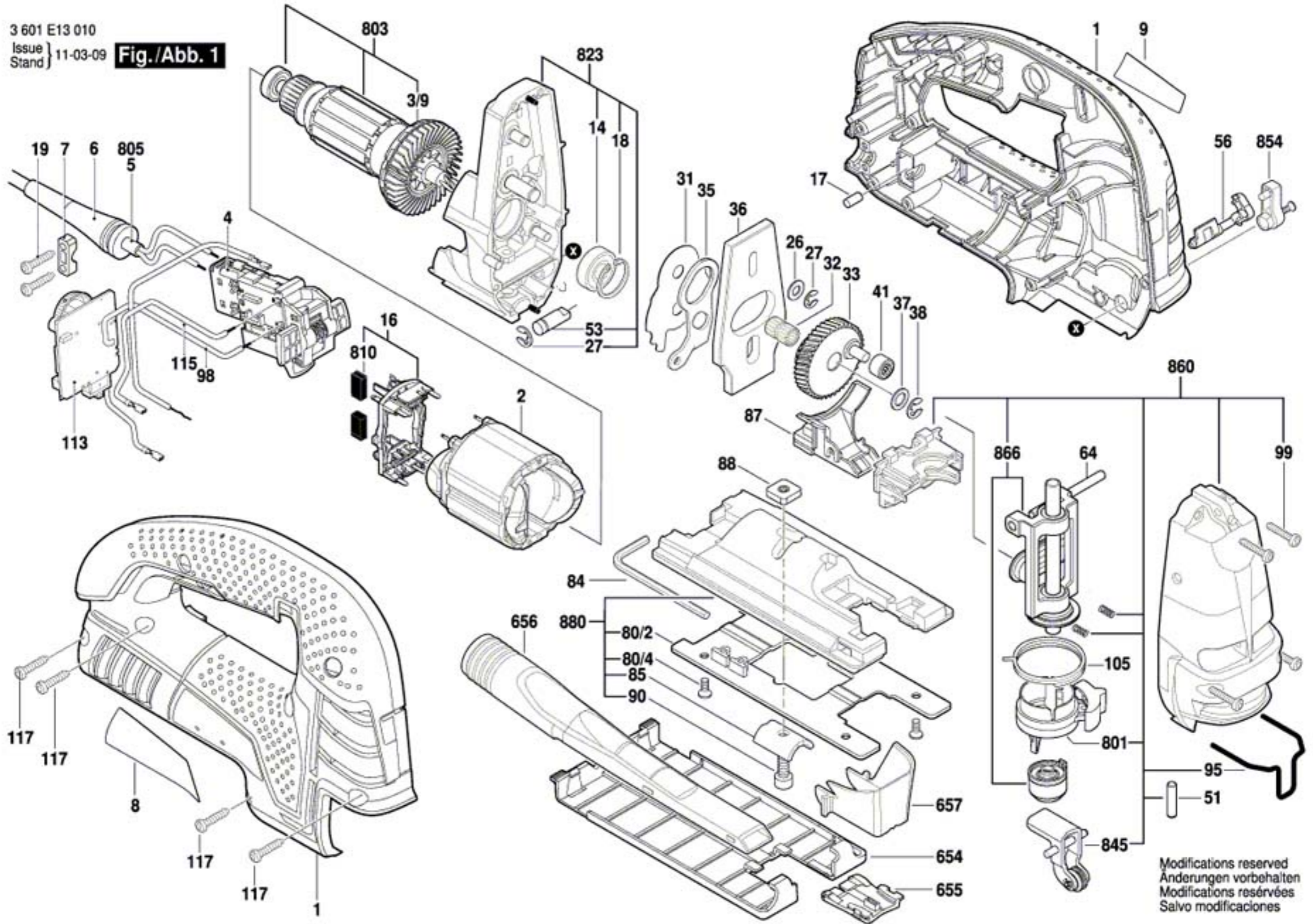

Modifications reserved
Änderungen vorbehalten
Modifications réservées
Salvo modificaciones