

Circular hand saw - F 012 HD7 711 - HD77

Item	Part Number	Description	Illustration	Price	Quantity	Price Group
1	1 619 X01 157	Motor Housing	1	-,-	1	-
2	1 619 P02 674	Field 120V	1	-,-	1	-
3	2 610 931 892	Armature 120V	1	-,-	1	44
4	1 619 X04 521	On-Off Switch	1	-,-	1	24
5	1 619 X02 235	Cord	1	-,-	1	-
6	1 619 X08 308	Grommet	1	-,-	1	-
7	1 619 X01 274	Cable Clip	1	-,-	1	-
13	2 610 017 348	Deep-Groove Ball Bearing	1	-,-	1	23
14	2 610 024 748	Ball Bearing	1	-,-	2	22
18	2 610 901 971	Screw	1	-,-	1	10
22	1 619 X01 208	Hood	1	-,-	1	-
23	1 619 X01 249	Washer	1	-,-	1	18
24	1 619 X02 969	Washer	1	-,-	1	21
25	1 619 X06 474	Oil Drain Plug	1	-,-	1	-
26	2 610 000 050	Collar bolt	1	-,-	1	14
27	1 619 X01 262	Stud	1	-,-	1	-
28	1 619 X03 956	Lower guard	1	-,-	1	-
31	2 610 017 875	Ball Bearing	1	-,-	1	20
32	1 619 X03 779	O-Ring	1	-,-	1	-
33	1 619 X06 927	Extension Spring	1	-,-	1	-
35	2 610 319 494	End stop	1	-,-	1	12
36	2 610 341 359	Spring retaining ring	1	-,-	1	12
37	2 610 023 394	Spring	1	-,-	1	11
38	1 619 X01 171	Upper guard	1	-,-	1	-
39	1 619 X01 237	Lever	1	-,-	1	-
40	1 619 X01 204	Handle	1	-,-	1	-
42	1 619 X01 253	Bearing Plate	1	-,-	1	-
43	1 619 X01 255	Guard Plate	1	-,-	1	-
44	1 619 X01 271	Bushing	1	-,-	1	-
45	1 619 X01 228	Cover	1	-,-	1	-
46	1 619 X01 268	Device cap	1	-,-	2	10
47	2 610 044 638	O-Ring	1	-,-	1	11
48	1 619 X01 272	Collar	1	-,-	1	-

Item	Part Number	Description	Illustration	Price	Quantity	Price Group
50	1 619 X01 267	Brush Holder	1	-,-	2	-
51	2 610 004 341	Washer	1	-,-	1	11
52	2 610 912 616	Washer	1	-,-	3	10
53	2 610 968 747	Spring retaining ring	1	-,-	2	10
54	1 619 X01 235	Locking Lever	1	-,-	2	-
55	2 610 000 166	Ball Bearing	1	-,-	1	-
56	2 610 027 039	Set screw	1	-,-	2	-
57	2 610 315 299	Screw	1	-,-	2	11
58	2 610 315 380	Screw	1	-,-	4	11
59	1 619 X03 644	Screw	1	-,-	1	-
60	2 610 023 331	Washer	1	-,-	1	11
61	2 610 025 067	Washer	1	-,-	1	11
63	2 610 329 955	Screw	1	-,-	2	11
64	1 619 X01 786	Contact Screw	1	-,-	4	10
65	2 610 306 355	Washer	1	-,-	2	11
66	1 619 X01 263	Stud	1	-,-	1	-
67	1 619 X01 298	Bearing bolt	1	-,-	1	-
68	2 610 353 799	Screw	1	-,-	4	11
69	2 610 356 026	Nut	1	-,-	1	11
70	1 616 B10 364	O-Ring	1	-,-	1	-
71	2 610 027 002	Screw	1	-,-	5	11
72	2 610 016 325	Bolt	1	-,-	1	10
73	2 610 004 459	Spring Washer	1	-,-	1	11
74	1 619 X01 257	Rubber Gasket	1	-,-	1	-
75	2 610 025 245	Seal	1	-,-	1	16
76	2 610 931 237	Spring Washer	1	-,-	1	10
77	2 610 017 016	Washer	1	-,-	1	11
78	2 610 329 927	Seal	1	-,-	1	15
79	2 610 993 549	Screw	1	-,-	2	-
80	1 619 X06 749	Screw	1	-,-	1	10
81	2 610 329 950	Screw	1	-,-	2	11
82	1 619 X01 258	Gasket	1	-,-	1	-
84	2 610 318 324	Nut	1	-,-	1	11
86	2 610 329 953	Screw	1	-,-	4	11
90	1 619 X01 260	Bearing Cover	1	-,-	1	-
91	2 610 353 289	Tapping Screw	1	-,-	4	11
92	2 610 932 218	Screw	1	-,-	2	11
93	1 619 X01 283	Nut	1	-,-	2	14
114	2 610 911 890	Screw	1	-,-	2	-
116	1 619 X01 264	Assembly Hook	1	-,-	1	-
651	1 619 X01 144	Socket wrench	1	-,-	1	-
808	1 619 X02 752	Nameplate	1	-,-	1	-
810	1 619 X01 351	Carbon-Brush Set	1	-,-	1	23
819	1 619 X01 350	Plate	1	-,-	1	-
821	2 610 352 057	Gear Housing	1	-,-	1	33
829	1 619 X01 363	Set Of Handles	1	-,-	1	24
834	1 619 X02 374	Set Of Gears	1	-,-	1	38

Illustration - Type E

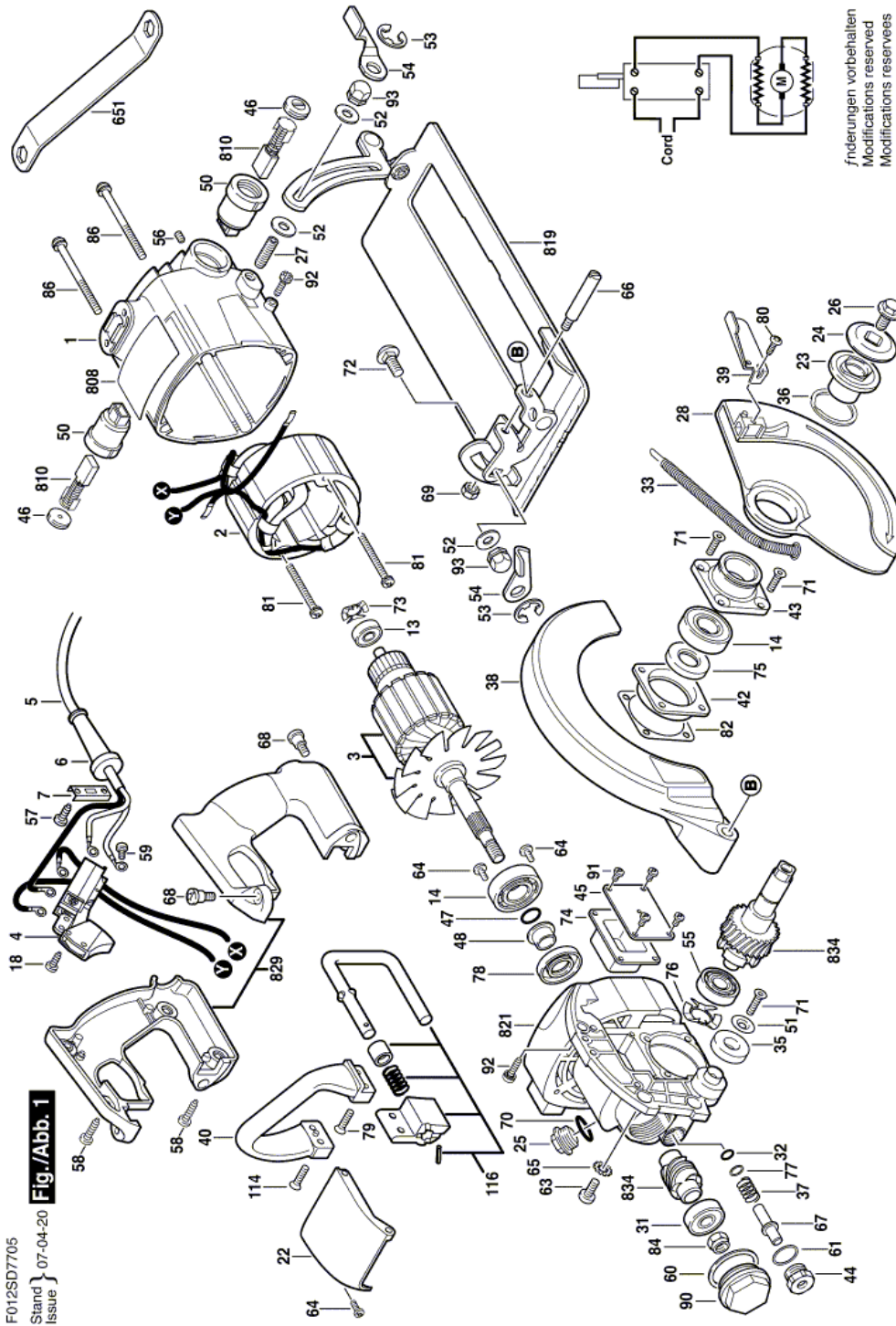

F012SD7705
 Stand } 07-04-20
 Issue } **Fig./Abb. 1**

Information subject to change without further notice.