

HB390V Blower UT-08031-C - Carburetor And Fuel Tank

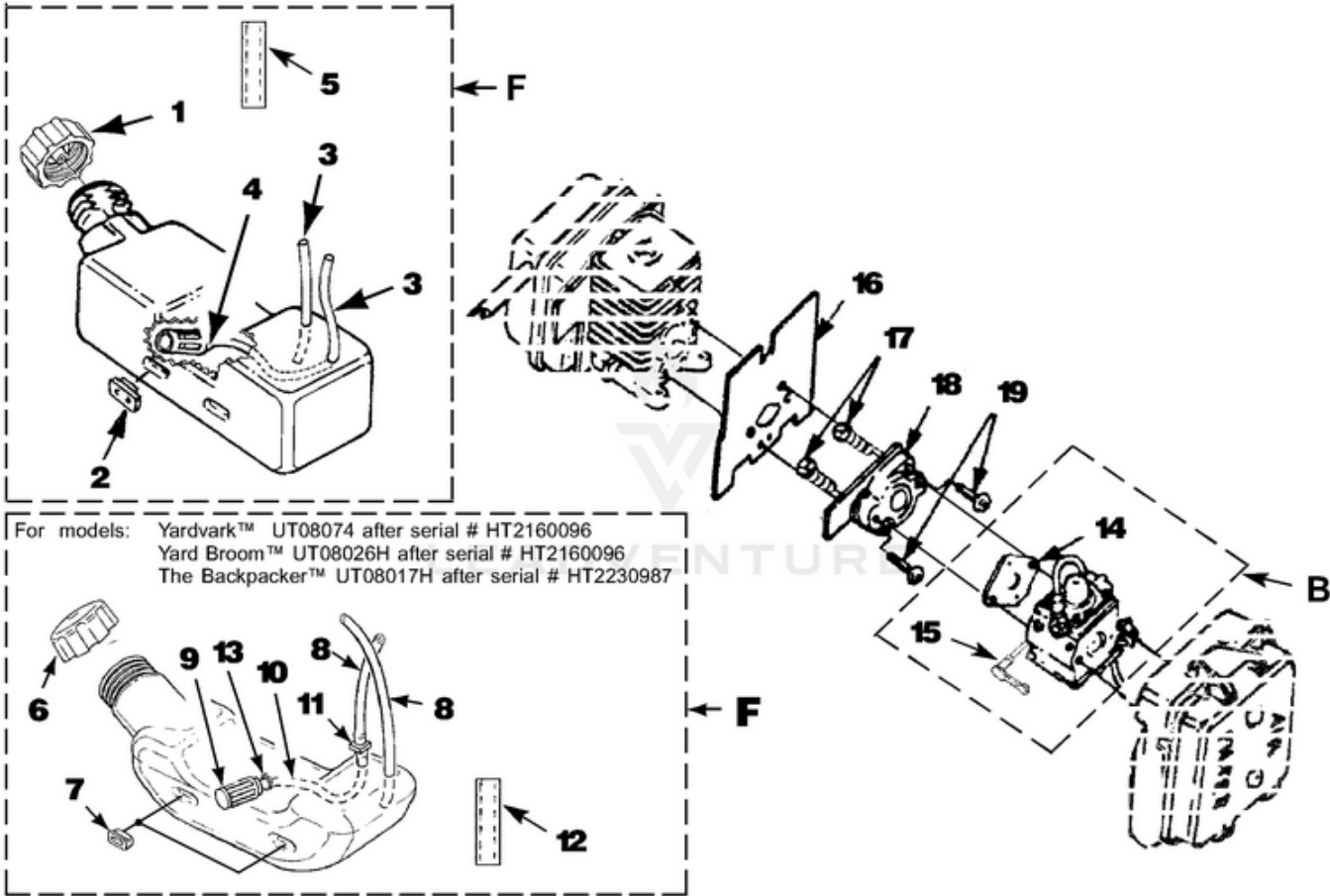

Rendered by LeadVenture, Inc.

Ref #	Part #	Description	Qty	Context Note
F	UP00136	FUEL TANK KIT	1	Includes items 1-5
1	UP04111	FUEL CAP (1 3/8" Opening)	1	
2	UP03501	BUMPER-Rubber	3	
3	7031032	TUBING-Rubber (8")	2	
4	UP03871	FUEL FILTER	1	
5	4283304	INSULATION-Tubing	1	
F	UP00136	FUEL TANK KIT	1	Includes items 6-13
6	UP00106	FUEL CAP (1 5/8" Opening)	1	
7	UP03501	BUMPER-Rubber	3	
8	UP03825	TUBING-Rubber (8")	2	
9	UP03871	FUEL FILTER	1	
10	UP03905	TUBING-Rubber (8")	1	
11	UP04310	Fitting, Inlet (small for 2.5mm ID fuel line)	1	
	UP03831	Fitting, Inlet (large for 3mm ID fuel line)	1	
12	UP04339	INSULATION-Tubing	1	
13	UP03913	CLAMP	1	
B	UP00651	CARBURETOR KIT	1	Includes items 14-15
14	UP03915	GASKET-Carburetor	1	Also included with Short block & Cylinder Kits.
15	UP03943	LEVER-Choke	1	(Walbro WT419, WT469)
	UP04278	LEVER-Choke	1	(Zama, H39)
B	UP00652	CARBURETOR KIT	1	(BP250's, Backpacker & BP30185); Includes items 14-15
14	UP03916	(GASKET-Carburetor)	1	Also included with Short block & Cylinder Kits.
15	UP03943	LEVER-Choke	1	(Walbro WT419,WT469)
	UP04278	LEVER-Choke	1	(Zama, H39)
B	UP00653	CARBURETOR KIT	1	(UT08026 E, F, G, H, J, UT08011 G, H, J); Includes items 14-15
14	UP03915	GASKET-Carburetor	1	Also included with Short block & Cylinder Kits.
15	UP03941	LEVER-Choke	1	
16	UP04308	GASKET-Heat Dam	1	Also included with Short block & Cylinder Kits.
17	UP04131	SCREW-Thread Form. (10-24 x 1")	2	Torque Specs 30-40 In/Lbs, 3.4-4.5 Nm.
18	UP04348	HEAT DAM	1	
19	UP04140	SCREW, SEMS (10-24 x 1.110)	2	Torque Specs 40-50 In/Lbs, 4.5-5.6 Nm. Required Loctite 262 Red; Also included with Short block & Cylinder Kits.

HB390V Blower UT-08031-C - Engine Internal

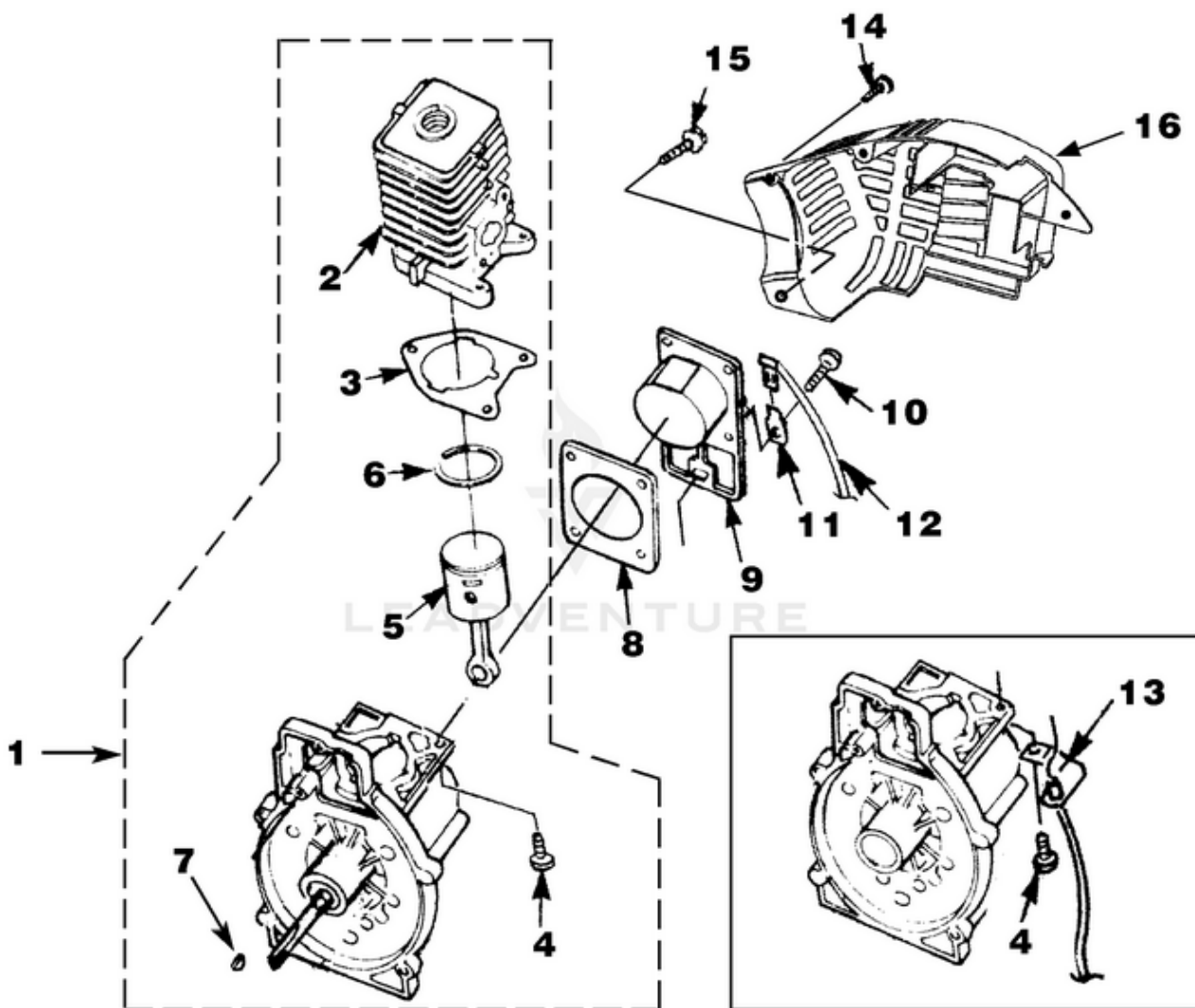

Rendered by LeadVenture, Inc.

Ref #	Part #	Description	Qty	Context Note
1	UP03121	SHORT BLOCK W/ Rotor (30cc)	1	Includes items 2-7
2	UP07146	30 CC CYLINDER KIT	1	Includes items 3-4
3	UP03857	GASKET-Cylinder	1	Also Included with Short Block & Cylinder Kits
4	UP04345	SCREW, SEMS (12-24 x 3/4)	3	Torque Specs 55-65 In/Lbs, 6.2-7.3 Nm. Required Loctite 262 Red
5	UP03366	30 CC PISTON & ROD	1	Includes item 6
6	UP03837	RING-Piston	2	Ring for single ring 30CC piston is 04933.
7	UP03874	KEY-Woodruff	1	
	UP03817	GASKET-Muffler	1	(Not Shown)
1	UP03123	SHORT BLOCK W/ Rotor (25cc)	1	Includes items 2-7
2	UP04136	25 CC CYLINDER KIT	1	Includes items 3-4
3	UP03857	GASKET-Cylinder	1	
4	UP04345	SCREW, SEMS (12-24 x 3/4)	3	Torque Specs 55-65 In/Lbs, 6.2-7.3 Nm. Required Loctite 262 Red
5	UP00768	25 CC PISTON & ROD	1	Includes item 6
6	UP03838	RING-Piston	1	
7	UP03874	KEY-Woodruff	1	
	UP03817	GASKET-Muffler	1	(Not Shown)
8	UP04335	GASKET-Crankcase	1	Torque Specs 55-65 In/Lbs, 6.2-7.3 Nm. Required Loctite 262 Red; Also Included with Short Block & Cylinder Kits
9	UP04336	CRANKCASE COVER-Stamped Steel	1	
10	UP04295	SCREW, SEMS (10-24 x .56)	4	(Use with stamped steel c/case cover); Also Included with Short Block & Cylinder Kits
9	UP03914	CRANKCASE COVER-Aluminum	1	
10	UP04277	SCREW, SEMS (10-24 x .810)	4	(Use with aluminum c/case cover); Also Included with Short Block & Cylinder Kits
11	UP03834	TAB-Male	1	
12	UP04302	CABLE-Throttle w/ Ignition Leads	1	(BP250's, Backpacker & BP30185)
13	UP04296	CABLE BRACKET	1	(BP250's, Backpacker & BP30185)
14	UP03893	SCREW-Thread Form. (#8 X 1/2")	3	Torque Specs 8-12 In/Lbs, .9-1.4 Nm.
15	UP03900	SCREW-Thread Form. (#10 X 3/4")	6	Torque Specs 20-30 In/Lbs, 2.3-3.4 Nm.
16	UP06522	SHROUD	1	
	UP06779	SHROUD-Flocked	1	(HB180-VI, HB390-VI)

HB390V Blower UT-08031-C - Ignition With Rotor

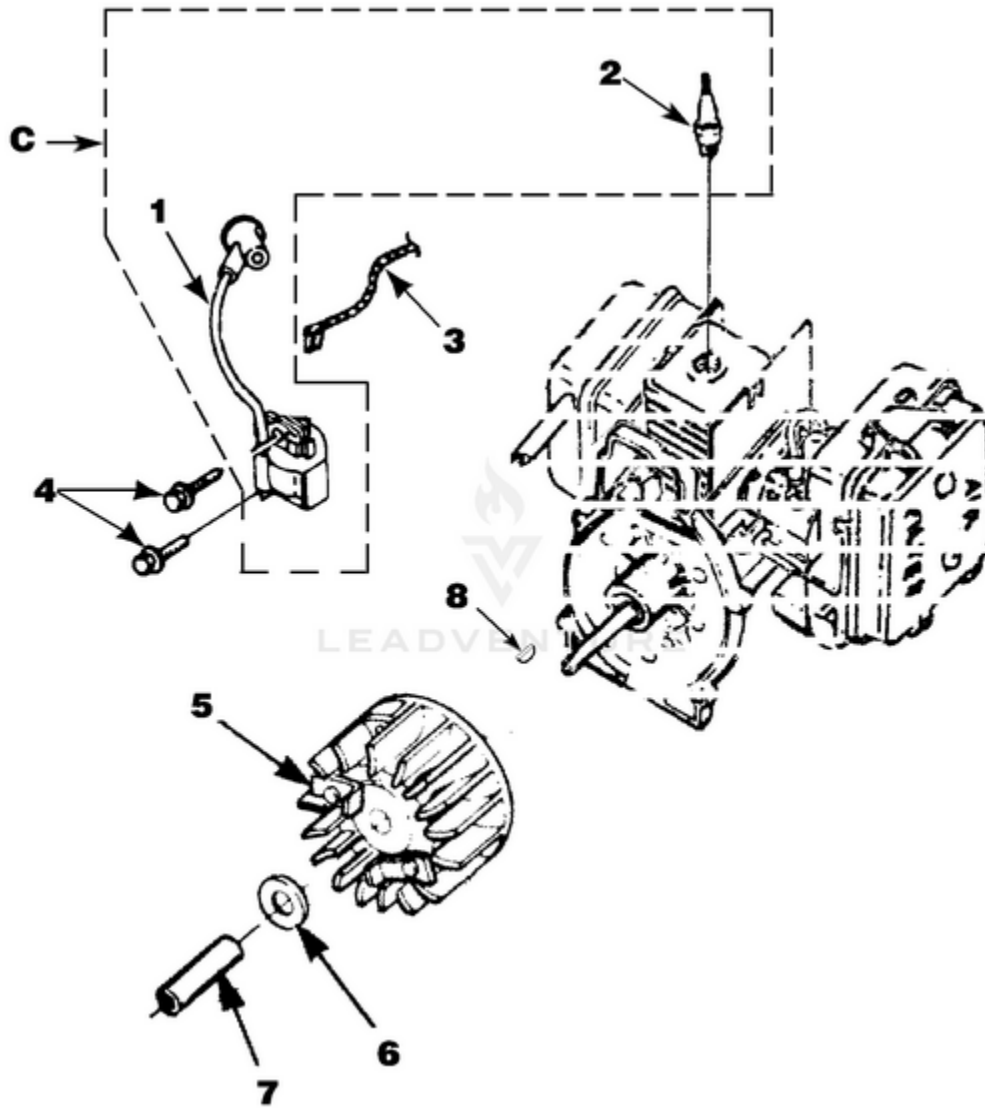

Rendered by LeadVenture, Inc.

Ref #	Part #	Description	Qty	Context Note
C	UP03858	IGNITION KIT w/ Module	1	Includes items 1-2
1	UP03868	TERMINAL-Hi-Tension	1	
2	UP03883	SPARK PLUG (RDJ-7Y)	1	Torque Specs 120-180 In/Lbs, 13.6-20.3 Nm.
3	A03924	LEAD-Electrical	1	(BP250's, Backpacker & BP30185)
4	UP03896	SCREW-Thread Form. (8-32 x 1")	2	Torque Specs 30-40 In/Lbs, 3.4-4.5 Nm. Required Loctite 242 Blue
5	UP03009	ROTOR & STARTER PAWLS	1	
6	UP03906	WASHER-Flat	1	
7	UP03854	SPACER-Fan	1	
8	UP03874	KEY-Woodruff	1	

HB390V Blower UT-08031-C - Muffler And Air Cleaner

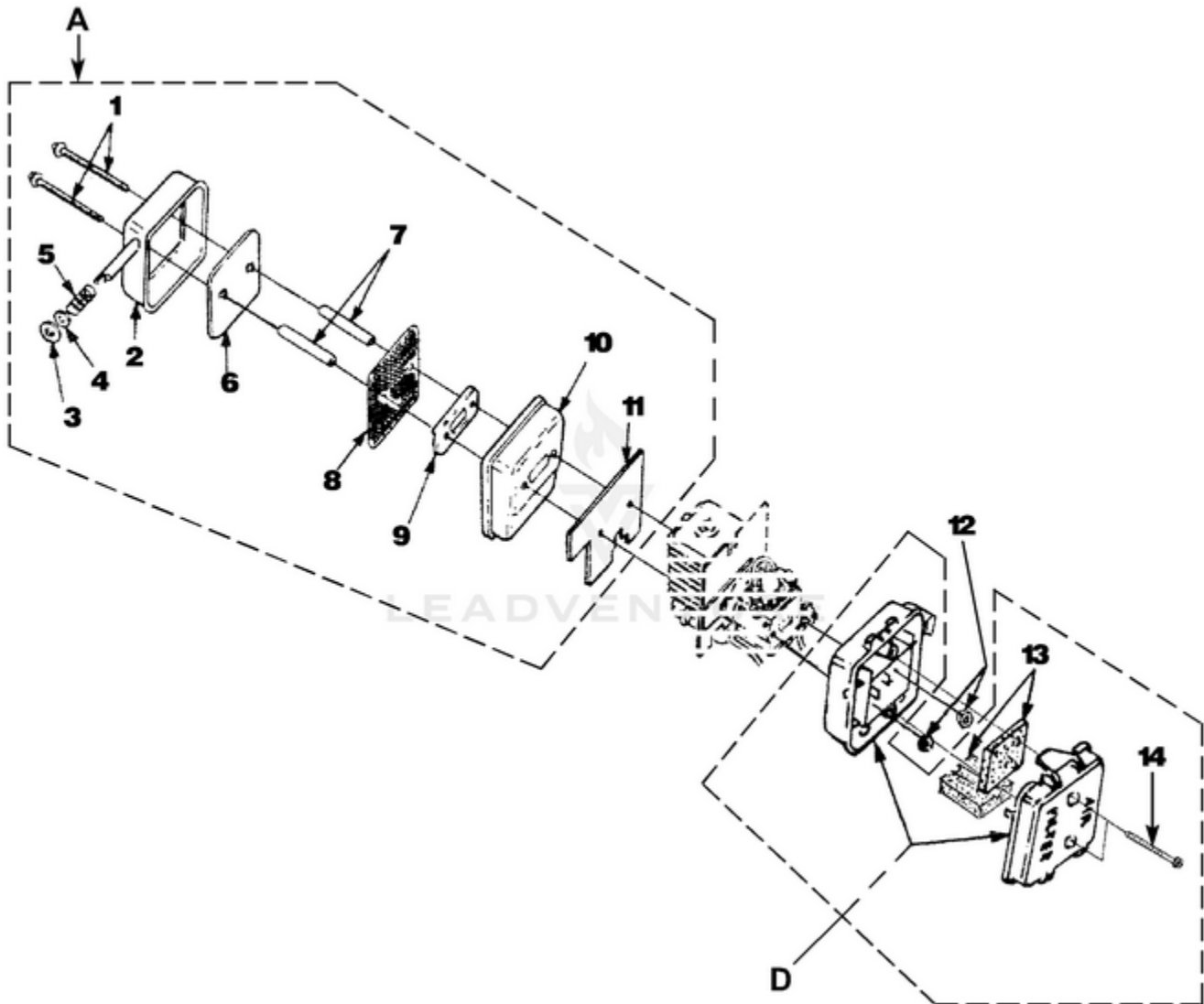

Rendered by LeadVenture, Inc.

Ref #	Part #	Description	Qty	Context Note
A	UP04486	MUFFLER-Complete	1	Includes items 1-11
1	UP03902	SCREW-Sems Hex Hd. (10-24 x 2 1/2")	2	Torque Specs 40-50 In/Lbs, 4.5-5.6 Nm.
2	UP03810	MUFFLER COVER	1	
3	UP03813	WASHER-Insulating	1	
4	UP03901	WASHER-Flat	1	
5	UP03814	SPRING-Compression	1	
6	UP04289	DEFLECTOR-Muffler	1	
7	UP03860	SPACER-Muffler	1	
8	UP03815	SCREEN-Spark Arrestor	1	
9	UP03918	PLATE-Reinforcing	1	
10	UP04305	BODY-Muffler	1	
11	UP03817	GASKET-Muffler	1	Also included with Short block & Cylinder Kits.
12	UP03885	NUT-Hex (10-24)	2	Torque Specs 30-40 In/Lbs, 3.4-4.5 Nm.
D	UP00011	AIR FILTER KIT	1	Includes items 13-14
13	UP00012	AIR FILTER	1	
14	UP03890	SCREW-Thd. Form. (#8-16 x 3/4")	2	Torque Specs 30-40 In/Lbs, 3.4-4.5 Nm.

HB390V Blower UT-08031-C - Starter

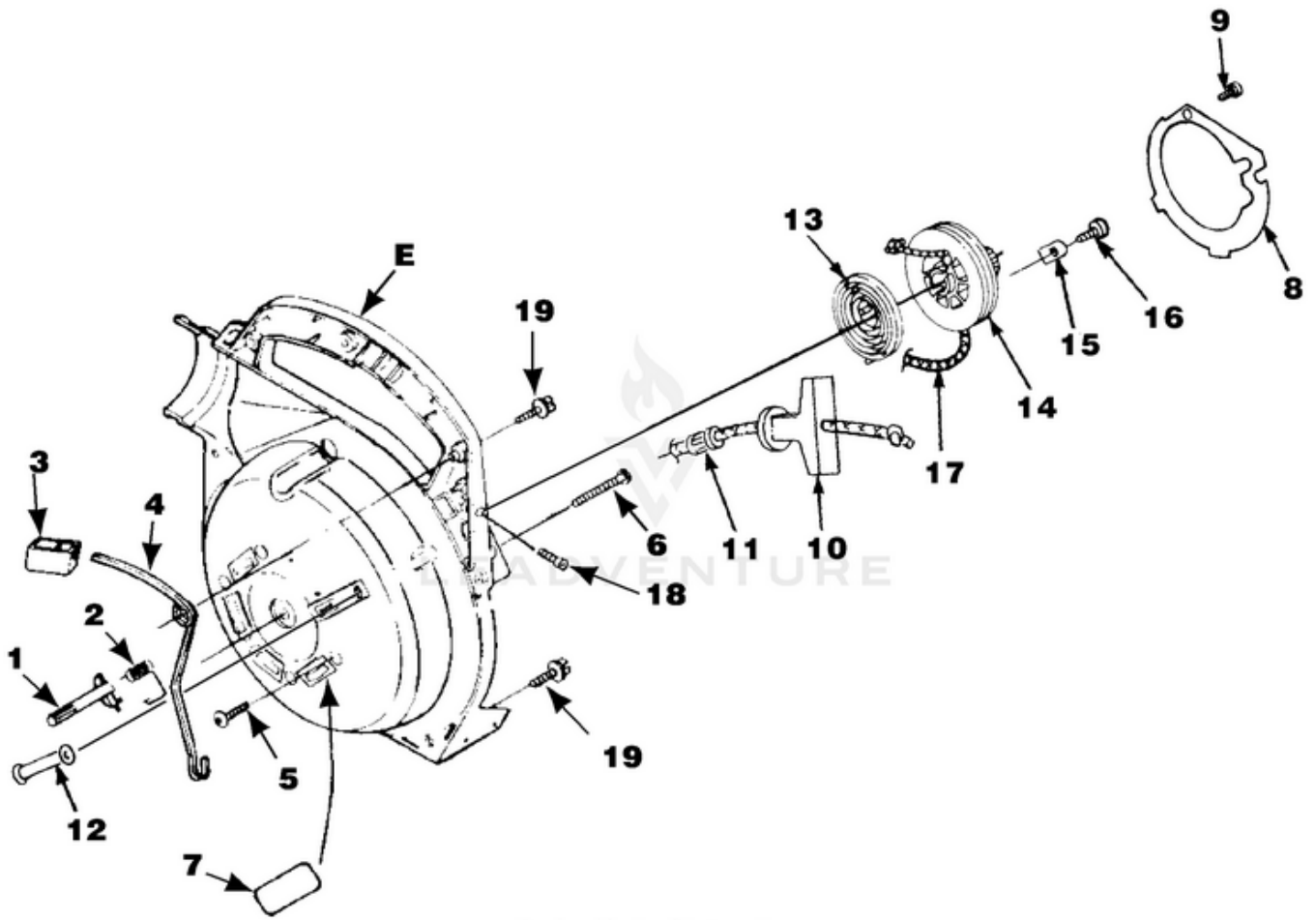

Rendered by LeadVenture, Inc.

Ref #	Part #	Description	Qty	Context Note
1	UP03800	LATCH-Throttle	1	
2	UP03811	SPRING-Throttle Latch	1	
3	UP03798	TRIGGER-Throttle	1	
4	UP03803	LEVER-Throttle	1	
5	UP03406	SCREW-Thread Form. (10-24 X 3/4")	4	Torque Specs 55-60 In/Lbs, 6.2-6.8 Nm.
6	UP03869	SCREW-Thread Form. (#10 X 1 5/8")	1	Torque Specs 20-30 In/Lbs, 2.3-3.4 Nm.
E	UP06792	VOLUTE HOUSING & STARTER	1	Includes items 7-17
7	UP03822	KIT-Sealing	1	
8	UP04279	PLATE-Rotor	1	
9	UP03894	SCREW-Thread Form. (#6 X 1 3/8")	1	Torque Specs 8-12 In/Lbs, .9-1.4 Nm.
10	UP04276	GRIP-Starter	1	
11	UP03910	BUSHING-Starter	1	
12	UP03809	BUSHING-Starter Rope	1	
13	UP03917	SPRING & CONTAINER	1	
14	UP04349	PULLEY-Starter	1	
15	UP03919	BRACKET-Retaining	2	
16	UP03897	SCREW-Thread Form. (#10 X 1/2")	2	Torque Specs 30-40 In/Lbs, 3.4-4.5 Nm.
17	UP03911	ROPE-Starter	1	
18	UP03887	SCREW-Phil. Hd. (8-32 X 5/8")	1	Torque Specs 20-30 In/Lbs, 2.3-3.4 Nm.
19	UP03900	SCREW-Thread Form. (10-24 X 3/4")	6	Torque Specs 20-30 In/Lbs, 2.3-3.4 Nm.

HB390V Blower UT-08031-C - Tubes -Accessories

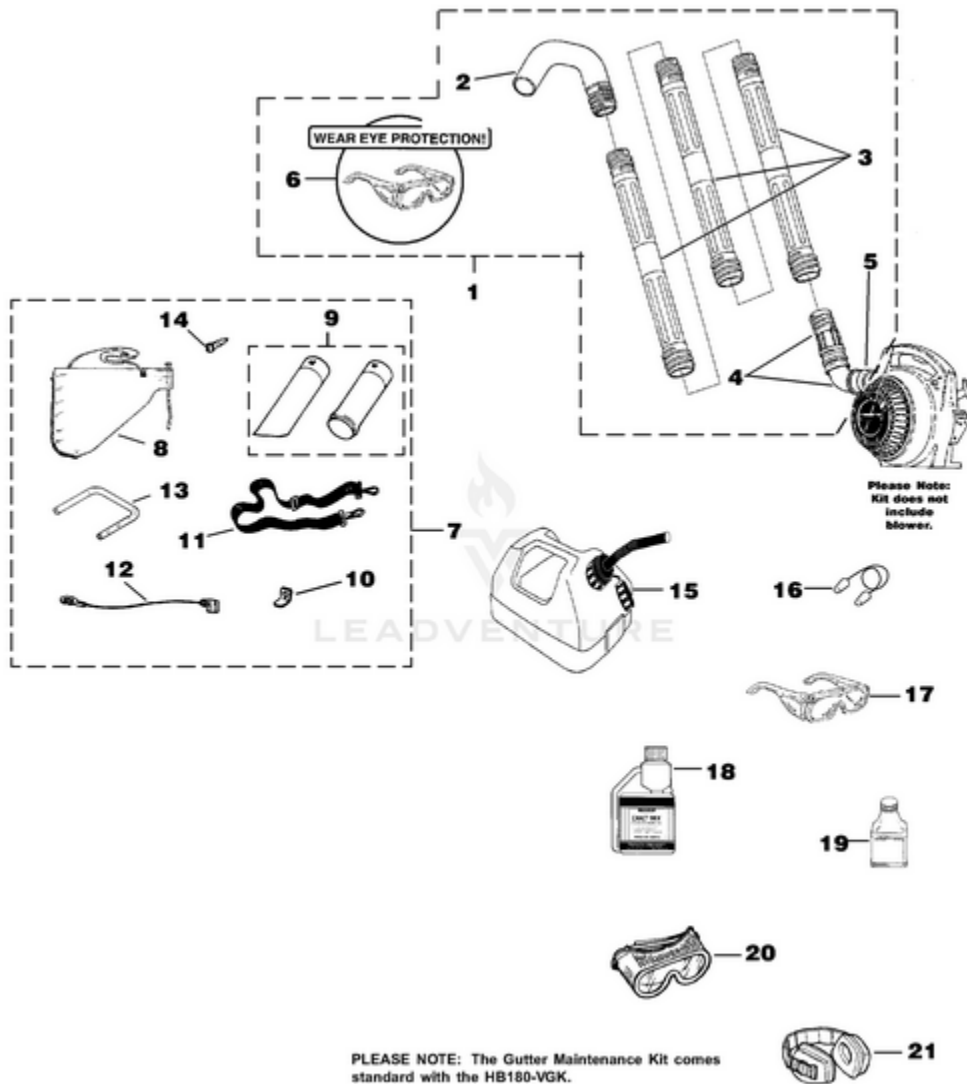

Please Note:
Kit does not
include
blower.

PLEASE NOTE: The Gutter Maintenance Kit comes standard with the HB180-VGK.

Rendered by LeadVenture, Inc.

Ref #	Part #	Description	Qty	Context Note
1	A02514D	GUTTER MAINTENANCE KIT	1	(HB100's, HB180's, HB25150, HB25150V, HB290's, HB390's); Includes items 2-6
2	UP06830	FULL ELBOW	1	
3	UP05618	STRAIGHT TUBE	3	
4	UP06836	UPPER ELBOW & SWIVEL ADAPTER	1	
5	UP03821	CLAMP w/Fasteners	1	
6	UP06835	SAFETY GLASSES-Clear	1	
7	UP04152	VACUUM KIT	1	(HB180's, HB25150, HB25150V, HB290's, HB390's); Includes items 8-14
8	UP04548	LEAF BAG	1	
9	UP06705	VACUUM TUBE KIT w/ Decal	1	
10	UP03834	TAB-Male	1	
11	UP06723	HARNESS-Shoulder	1	
12	UP03823	LEAD-Ground	1	
13	UP03816	HANDLE	1	
14	UP03889	SCREW	1	
15	A02976A	GAS CAN 1 1/4 Gallon		
16	UP06839	EAR PLUGS		
17	UP06835	SAFETY GLASSES-Clear		
18	01231D	EXACT MIX(TM) Oil - 1 pint (50:1)		
19	08581	EXACT MIX(TM) Oil - 2.6 oz. (50:1)		
20	UP06778	GOGGLES		
21	UP07694	EAR PROTECTORS		

HB390V Blower UT-08031-C - Volute, Fan & Tubes

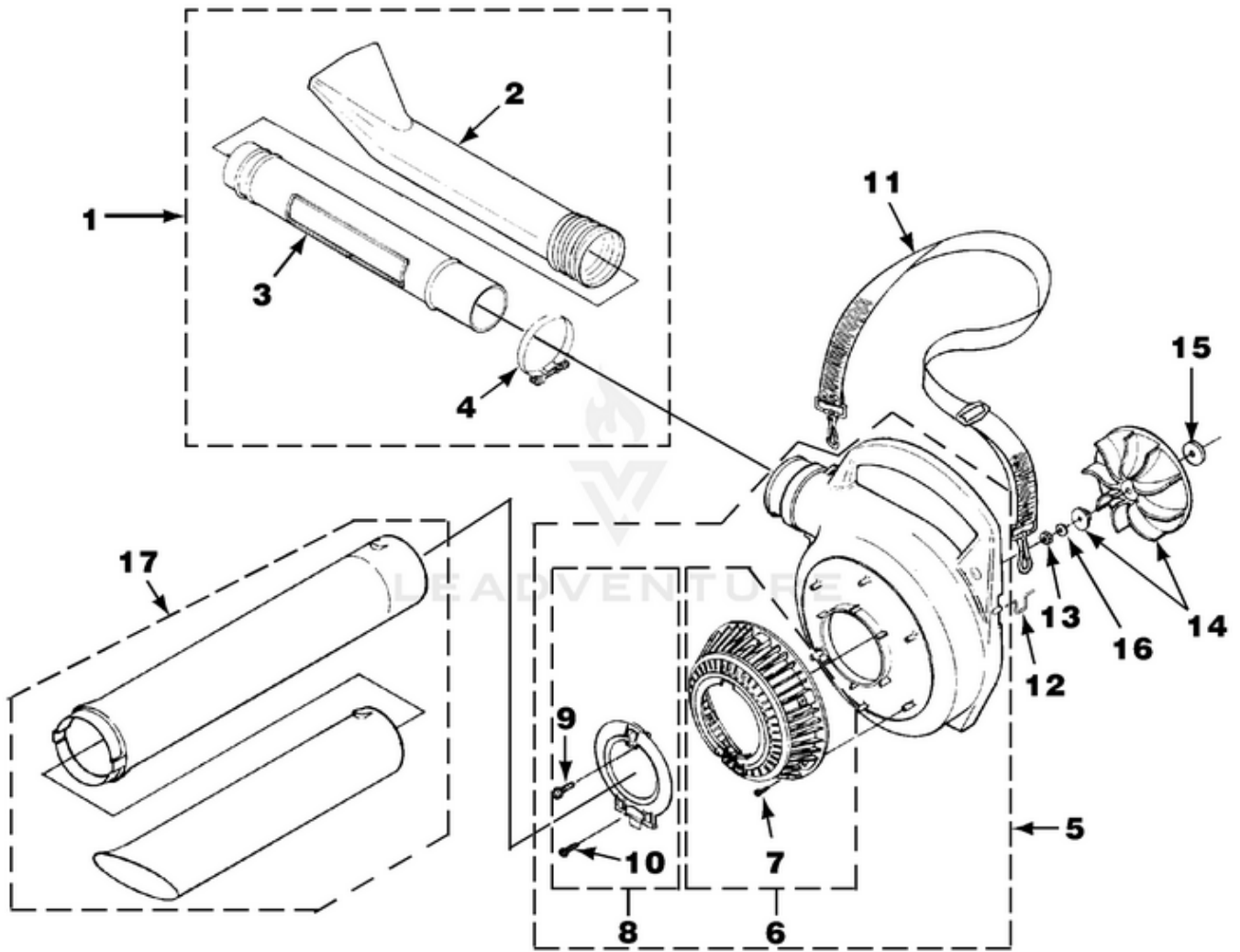

Rendered by LeadVenture, Inc.

Ref #	Part #	Description	Qty	Context Note
1	UP06741	BLOWER TUBE KIT	1	Includes items 2-4
2	UP03812	NOZZLE-Sweeper	1	
3	UP04365	TUBE	1	
4	UP03821	CLAMP w/Fasteners	1	
5	UP03861	VOLUTE HOUSING KIT	1	Includes items 6-10
6	UP06720	BLOWER VAC GRILLE KIT	1	Includes item 7
7	UP03894	SCREW-Thread Form. (#6 X 3/8")	6	Torque Specs 8-12 In/Lbs, .9-1.4 Nm.
8	UP06613	ACCESS DOOR KIT	1	Includes items 9-10
9	UP03888	SCREW-Thread Rolling (#10 X 5/8")	1	Torque Specs 10-20 In/Lbs, 1.1-2.3 Nm.
10	UP03893	SCREW-Thread Form. (#8 X 1/2")	1	Torque Specs 8-12 In/Lbs, .9-1.4 Nm.
11	UP06723	SHOULDER STRAP	1	
12	UP03818	WIRE LOOP	1	
13	UP03884	NUT-Hex (3/8-24)	1	Torque Specs 130-150 In/Lbs, 14.7-16.9 Nm.
14	UP06826	BLOWER FAN KIT	1	
15	UP03836	WASHER-Flat	2	
16	UP03835	WASHER-Bellville (3/8")	1	
17	UP06705	TUBE Kit w/Decals	1	(Vacuum units only)