

Illustration - Type - E

0 601 B23 503
 Stand } 04-01
 Issue } 09-08-31

Fig./Abb. 1

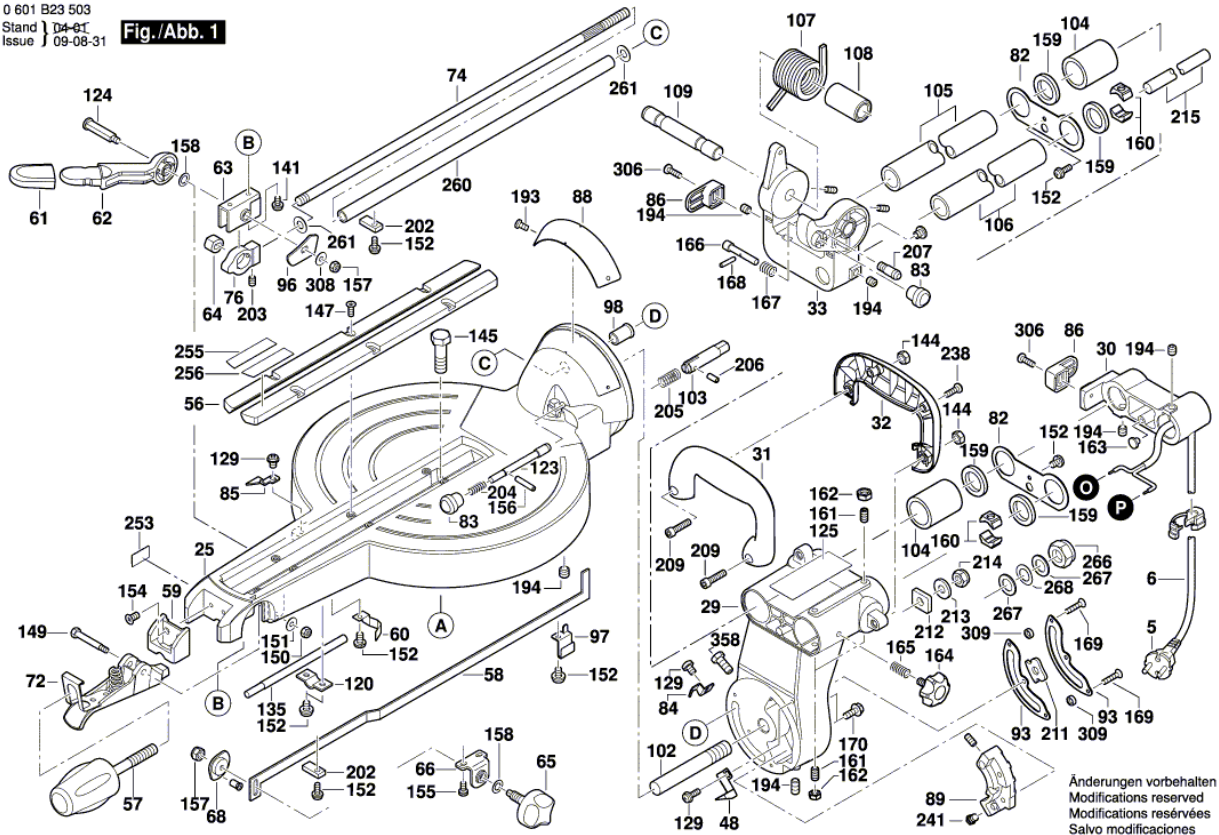
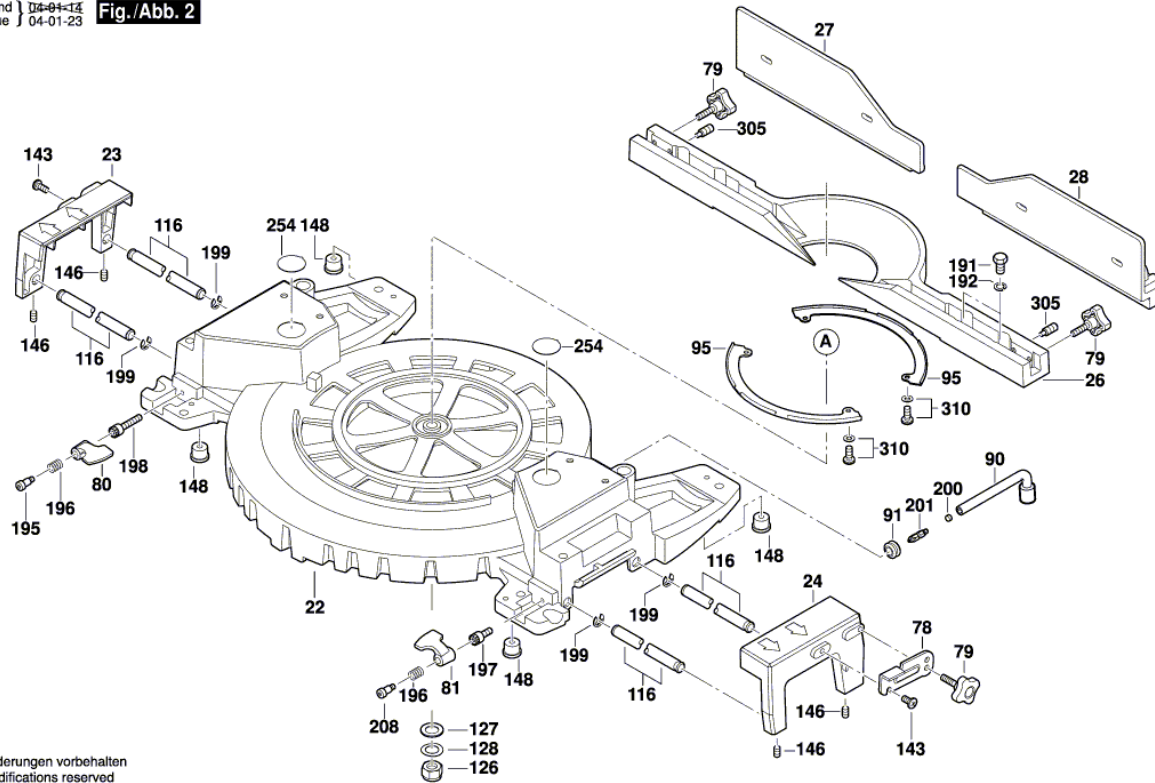

Illustration - Type - E

0 601 B23 503
 Stand | 04-14
 Issue | 04-01-23 **Fig./Abb. 2**



Änderungen vorbehalten
 Modifications reserved
 Modifications réservées
 Salvo modificaciones

Illustration - Type - E

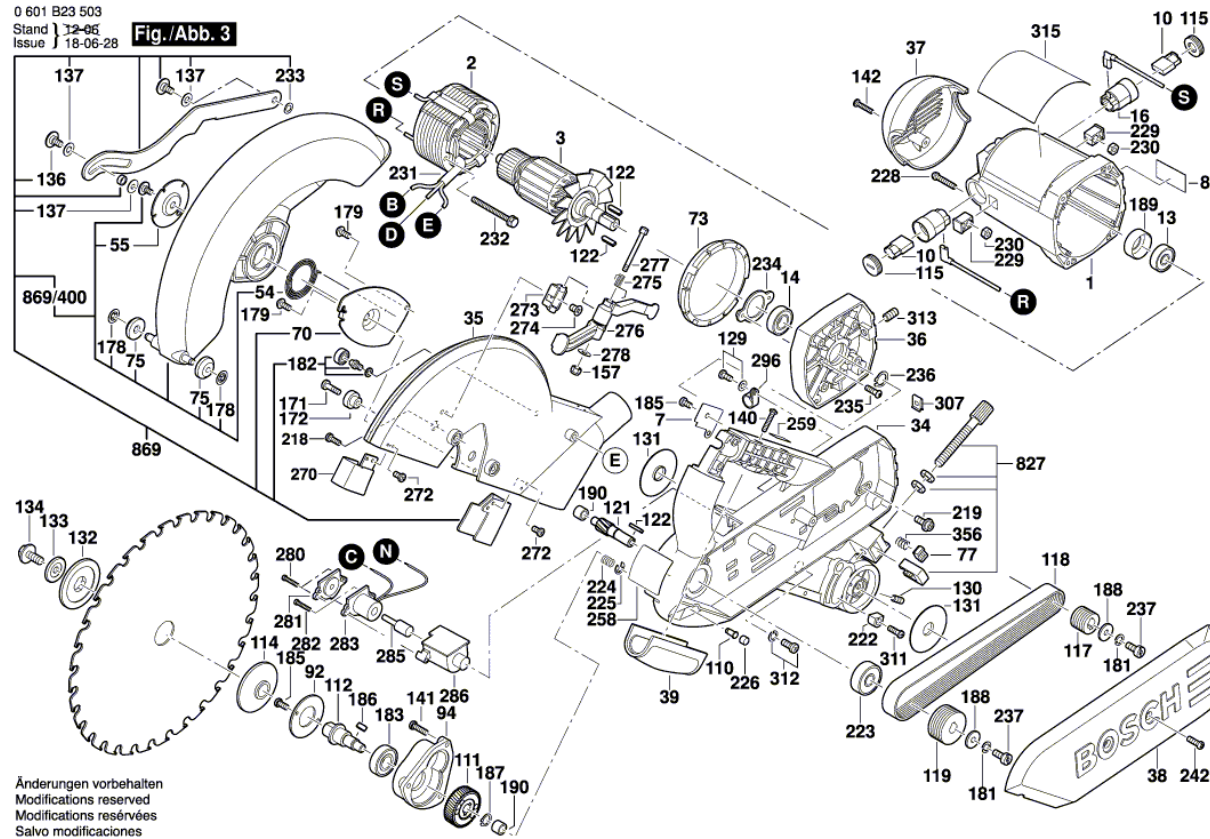
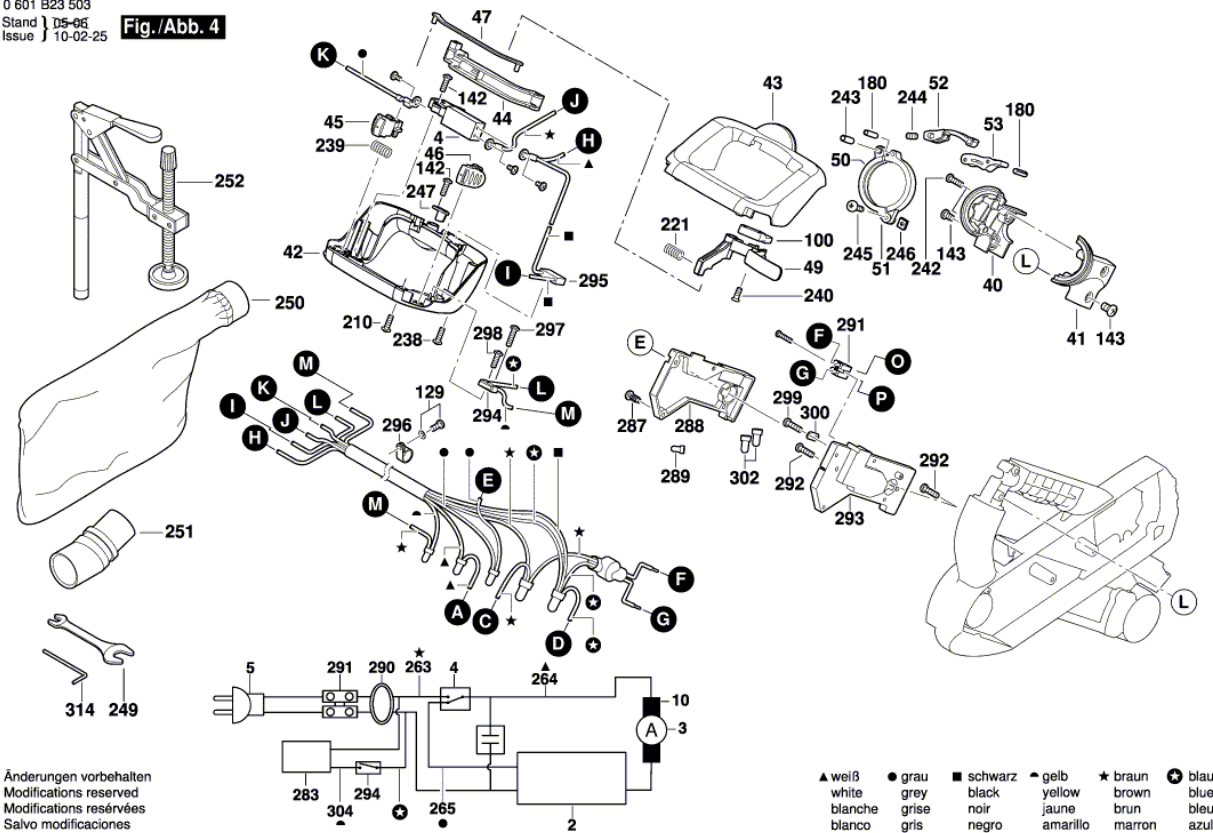

Illustration - Type - E

0 601 B23 503
 Stand } 05-06
 Issue } 10-02-25

Fig./Abb. 4



Änderungen vorbehalten
 Modifications reserved
 Modifications réservées
 Salvo modificaciones