

MODEL : F13S - 17UMS

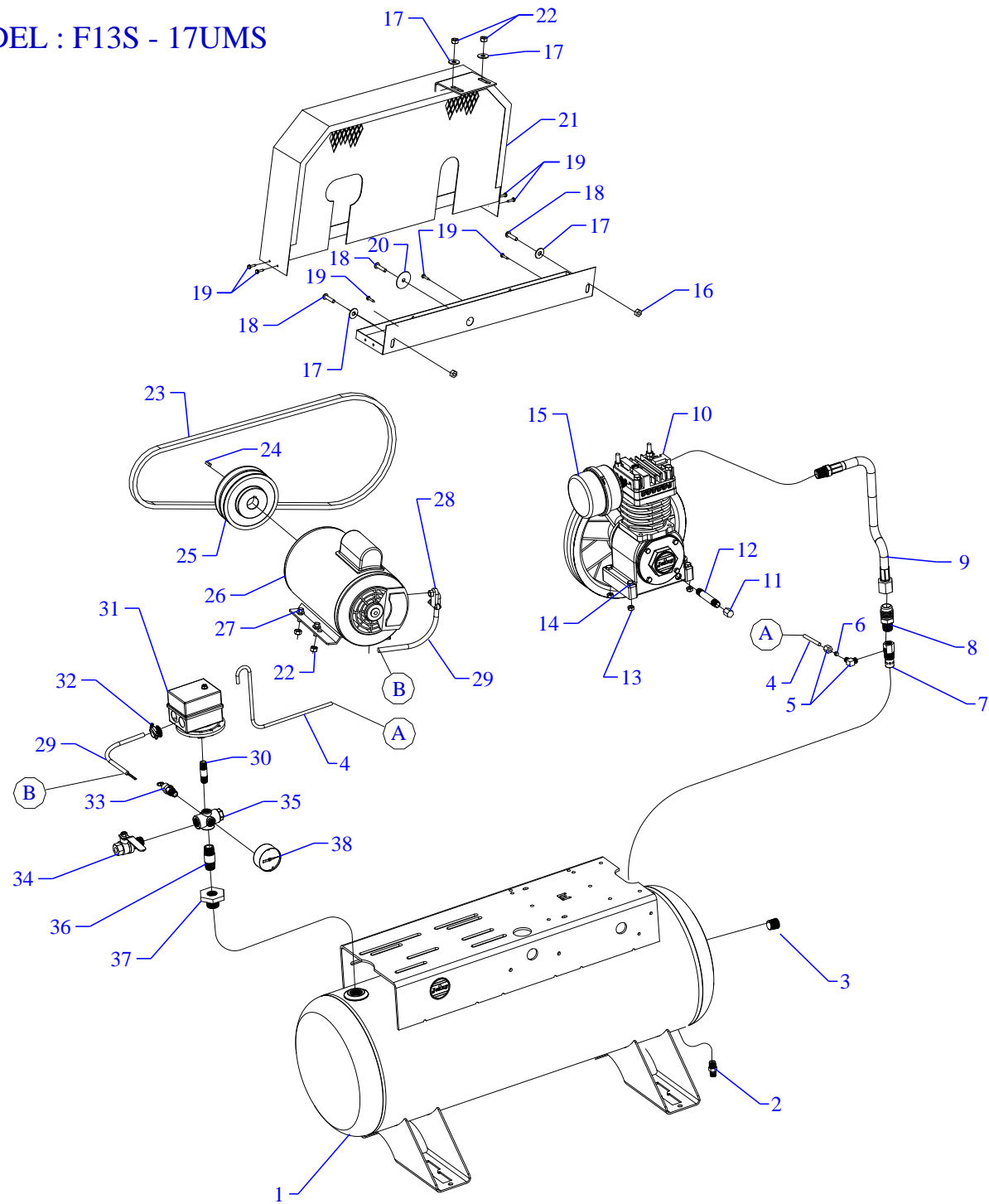

Parts List for Model F13S-17 Single Phase

NOTE: The quantity number indicates the total number of pieces required for a complete unit repair.
When ordering parts give compressor model, serial number and part number. Order assemblies when possible.

<u>REF. NO.</u>	<u>PART NO.</u>	<u>DESCRIPTION</u>	<u>QTY.</u>
1	411-1032	TANK,HRZNTL,17G,UM,F&K&GE,H17UM-4	1
2	141-1058	DRAIN,PETCOCK,BRASS,1/4"NPTM,DC14	1
3	122-1047	PLUG,SOCKET,HEX,ST,PLTD,1/2" NPT	1
4	610-1090	TUBE,CONTROL,COPPER,W/SLEEVE,1/4"X39"LG	1
5	121-1032	ELBOW,MALE,COMPRESSION,BR,1/4TBX1/8"NPTM	1
6	121-1080	SLEEVE,COMPRESSION,BRASS,1/4"	1
7	141-1034	VALVE,CHECK,INSERT,1/2"M X3/8"F,W/1/8"PT	1
8	121-1005	CONNECTOR,MALE,BRASS,1/2-45SAEX3/8"NPTM	1
9	360-1390	AFTERCOOLER,HOSE,SS,TEFLON,5/8"ODX16-1/2	1
10	421-1001	PUMP,CMPRSR,PISTON,REPLCMT,BLUE,F	1
11	122-1126	CAP,HEX,MI,PLATED,1/4"NPT	1
12	122-1034	NIPPLE,STEEL,SCH 40,1/4" X 5" L	1
13	120-1116	NUT,LOCK,FLANGE,HEX,SERR,ST,PLTD,1/4-20	4
14	120-1220	SCREW,CAP,HEXHD,GR5,ST,PLD,1/4-20X1-3/4	4
15	320-1121	FILTER,W/DECALS,ASSY,G154S	1
16	120-1116	NUT,LOCK,FLANGE,HEX,SERR,ST,PLTD,1/4-20	2
17	120-1075	WASHER,FLAT,STEEL,PLATED,5/16"	4
18	120-1267	SCREW,PAN HD,PHIL,STEEL,PLTD,1/4-20 X 1"	3
19	120-1177	SCREW,SELF DRILL,HEX,ST,PL,12 X 3/4	7
20	120-1072	WASHER,FENDER,ST,PLATED,1/4"X1-1/2"OD	1
21	320-1177	BELTGUARD,ELECTRIC,K,ASSY,BLUE,LOUVERED	1
22	120-1119	NUT,LOCK,FLANGE,HEX,SERR,ST,PLTD,5/16-18	6
23	154-4L450	BELT,VEE,A43,4L-450	1

Parts List for Model F13S-17 Single Phase

NOTE: The quantity number indicates the total number of pieces required for a complete unit repair.
When ordering parts give compressor model, serial number and part number. Order assemblies when possible.

<u>REF. NO.</u>	<u>PART NO.</u>	<u>DESCRIPTION</u>	<u>QTY.</u>
24	120-1108	KEY,STEEL,BLACK,3/16X3/16X 1-1/2" LENGTH	1
25	154-1208	PULLEY,CI,SG,4.0PDA,5/8ID,AK44X5/8	1
26	130-1000	MOTOR,1/3HP,115-208-230/60/1,1725RPM,ODP	1
27	120-1018	SCREW,FLANGE,HEX,SERR,ST,PLD,5/16-18X3/4	4
28	123-1032	CONNECTOR,CABLE,BX,90 DEG,3/8"	1
29	123-1003	WIRE,ASSY,BX,14/2,WITH GROUND	2FT
30	122-1137	NIPPLE,CLOSE,STEEL,SCH 40,PLATED,1/4"	1
31	140-1079	SWITCH,PSI,2HP,30-40#,UNLOADER,PAV 14-60	1
32	123-1029	CONNECTOR,ROMEX,CLAMP,STRAIGHT,3/8"	1
33	141-1018	VALVE,SAFETY,ASME,1/4",65 PSI,SVU65	1
34	141-1078	VALVE,BALL,OUTLET,1/4 TURN,1/2"M X 1/2"F	1
35	220-1059	BLOCK,MANIFOLD,AL,5 PORT,SPRINKLER,MC-5S	1
36	122-1088	NIPPLE,STEEL,SCH 80,PLATED,1/2" X 2"	1
37	122-1206	BUSHING,REDUCER,HEX,ST,PLTD,3/4" X 1/2"N	1
38	142-1000	GAUGE,PSI,200#,BK MT,JENNY,2",1/4NPT,PG2	1
NOT SHOWN	610-1225	KIT,ELEMENT,FILTER,G54E,PKG OF 4,G54EP	1
NOT SHOWN	105-1209	OIL,PUMP,SYNTHETIC,BLUE,1 QUART,ESQ	1

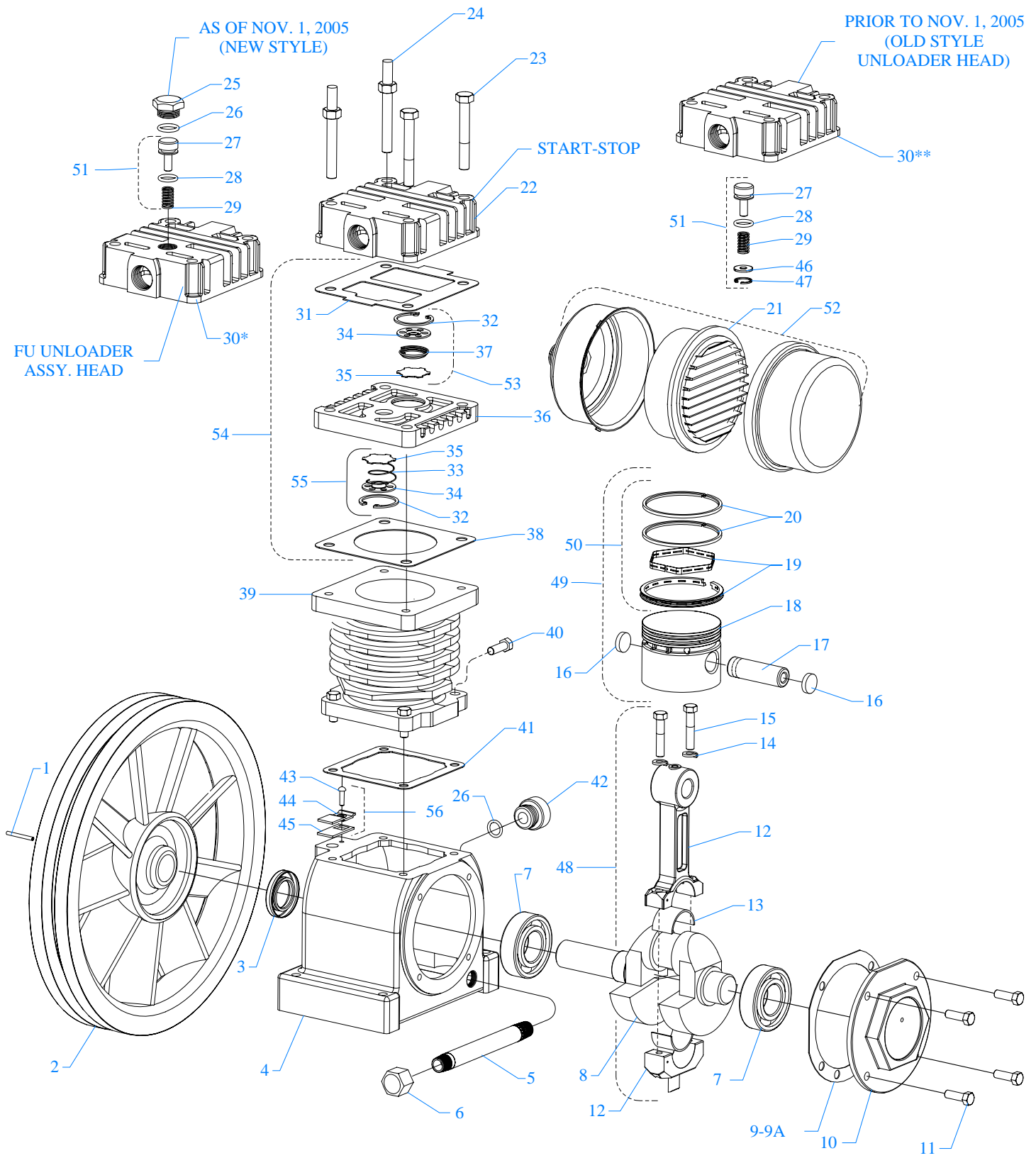

MODEL F & FU
One Cylinder Single Stage
2-1/2" Bore X 1-3/4" Stroke

Parts List for Model F & FU Pump Assembly

NOTE: The quantity number indicates the total number of pieces required for a complete unit repair.
When ordering parts give compressor model, serial number and part number. Order assemblies when possible.

<u>REF. NO.</u>	<u>PART NO.</u>	<u>DESCRIPTION</u>	<u>QTY.</u>
1	120-1163	PIN,ROLLED,COILED,STL,BLK,1/4ODX1L,K25	1
2	220-1093	FLYWHEEL,K PUMP,CI,10-3/8,1 GROOVE,K23A	1
3	150-1036	SEAL,OIL,LIP,SINGLE,0.875 DIA,K11E	1
4	220-1000	CRANKCASE,F PUMP,CI,MACHINED,F1	1
5	122-1034	NIPPLE,STEEL,SCH 40,1/4" X 5" L	1
6	122-1083	CAP,HEX,MI,1/4"NPT	1
7	150-1000	BEARING,BALL,K9	2
8	220-1002	CRANKSHAFT,F PUMP,CI,MACHINED,F20A	1
9	104-1000-01	GASKET,CAP,BEARING,F&K&G PUMP,1/32THK,L3	1
9A	104-1000-02	GASKET,CAP,BEARING,F&K&G PUMP,1/64THK,L4	1
10	220-1001	CAP,BEARING,K PUMP,CI,MACHINED,K2	1
11	120-1004	SCREW,CAP,HEXHD,GR5,ST,BLK,1/4-20X3/4 (10 FTLB)	4
12	310-1001-01	ROD,CONNECTING,ALUM,MACHINED,L21L&L21K	1
13	150-1011	BEARING,ROD,CONNECTING,PUMP,F,K,G	2
14	120-1010	WASHER,LOCK,SPLIT,ST,BLK,HIGH CLLR,1/4"	2
15	120-1010	SCREW,ROD,STEEL,W/LOCK WASHER,1/4-20,L22 (10 FTLB)	2
16	104-1103	BUMPER,WRIST PIN,PLASTIC,K36A	2
17	150-1005	PIN,PISTON,STEEL,HARDENED,K35	1
18	220-1005	PISTON,PUMP,ALUMINUM,MACHINED,K32	1
19	610-1065	KIT,RING,OIL,W/EXPANDER,ASSY,K34	1
20	150-1003	RING,COMPRESSION,PISTON,STEEL,EBA 22,K33	2
21	150-1104	ELEMENT,FILTER,AIR,COMPRESSOR,JENNY,G54E	1
22	220-1007	HEAD,START/STOP,F PUMP,CI,MACHINED,F50	1
23	120-1028	SCREW,CAP,HEXHD,GR5,ST,BLK,5/16-18X2-1/4 (22 FTLB)	2

Parts List for Model F & FU Pump Assembly

NOTE: The quantity number indicates the total number of pieces required for a complete unit repair.
When ordering parts give compressor model, serial number and part number. Order assemblies when possible.

<u>REF. NO.</u>	<u>PART NO.</u>	<u>DESCRIPTION</u>	<u>QTY.</u>
24	120-1252	BOLT,STUD,HEX,ST,5/16-18X2-1/4X5/8,K52-1 (22 FTLB)	2
25	122-1051	PLUG,HEX ,BRASS,11/16-16 UN-2B X .550	1
26	104-1015	RING,O,BUNA-N,1/2"IDX11/16"ODX3/32"THK	2
27	150-1028	PISTON,UNLOADER,VALVE,BRASS,KU81	1
28	104-1020	RING,O,SILICON,7/16"IDX5/8"ODX3/32"THK	1
29	150-1020	SPRING,VALVE,UNLOADER,INTAKE, KU83	1
30	310-1005	HEAD,UNLOADING,F PUMP,ASSY,FU180	1
31	104-1005	GASKET,HEAD,F PUMP,1/32THK,F51	1
32	150-1041	RETAINER,VALVE,STEEL,PAS,0.062"THK,K43	2
33	150-1017	SPRING,CONE,SS,VALVE,INTAKE,K45	1
34	109-1010	VALVE,BUMPER,STEEL,K44	2
35	109-1011	VALVE,DISC,STAINLESS STEEL,K47	2
36	220-1006	PLATE,VALVE,F PUMP,CI,MACHINED,F40	1
37	150-1018	SPRING,CONE,SS,VALVE,DISCHARGE,K46	1
38	104-1004	GASKET,PLATE,VALVE,F PUMP,1/32THK,F41	1
39	360-1151	CYLINDER,F PUMP,CI,PAINTED,BLUE,F30	1
40	120-1004	SCREW,CAP,HEXHD,GR5,ST,BLK,1/4-20X3/4 (10 FTLB)	4
41	104-1003	GASKET,CYLINDER,F PUMP,1/32THK,F31	1
42	610-1021	PLUG,CRANKCASE,FILL,OIL,W/O-RING,F14	1
43	120-1162	PIN,GROOVE,STEEL,PLATED,# 7X1/2"LONG,K18	1
44	230-1001	RETAINER,BREATHER,CRANKCASE,PLASTIC,F17	1
45	230-1000	SEAL,BREATHER,CRANKCASE,RUBBER,F16	1
46	150-1042	WASHER,BRASS,1/32X 0.605ODX1/4 ID,KU84	1

Parts List for Model F & FU Pump Assembly

NOTE: The quantity number indicates the total number of pieces required for a complete unit repair.
When ordering parts give compressor model, serial number and part number. Order assemblies when possible.

<u>REF. NO.</u>	<u>PART NO.</u>	<u>DESCRIPTION</u>	<u>QTY.</u>
47	120-1167	RETAINER,INTERNAL,ST,0.035X 0.665,KU85	1
Assemblies			
48	310-1043	ROD,CONNECTING,W/BEARNG INSERT,L21L&L21K INCLUDES 12,13,14(2),15(2)	1
49	610-1028	PISTON,W/RINGS&PIN,ASSY,K132 INCLUDES 16(2), 17, 18, 19, 20(2)	1
50	610-1019	KIT,PUMP,RING,PISTON,F PUMP,ASSY,F133 INCLUDES 19, 20 (2)	1
51	610-1042	VALVE,UNLOADER,HEAD,PUMP,ASSY,KU181 INCLUDES 27, 28, 29, 46, 47	1
52	320-1121	FILTER,W/DECALS,ASSY,G154S	1
53	610-1031	VALVE,SUCTION,ASSY,K145 INCLUDES 32, 33, 34, 35	1
54	610-1023	PLATE,VALVE,W/VALVES,ASSY,F140 INCLUDES 31, 36, 38, 53, 55	1
55	610-1032	VALVE,DISCHARGE,ASSY,K146 INCLUDES 32, 34, 35, 37	1
56	610-1018	VALVE,BREATHER,CRANKCASE,F PUMP,ASY,F119 INCLUDES 43, 44, 45	1
57	610-1016	KIT,GASKET,F PUMP,ASSY,F100 INCLUDES 9, 9A, 31, 38 ,41	1
58	610-1139	KIT,BASIC,REPAIR,F PUMP,F101 INCLUDES 21, 50, 53, 55, 56, 57 W/G54E	1
58A	610-1139	KIT,BASIC,REPAIR,F PUMP,F101 INCLUDES 50, 53, 55, 56, 57 W/F54 OLD STYLE	1
59	610-1140	KIT,BASIC,REPAIR,FU PUMP,FU101 INCLUDES 51, 58 W/G54E	1
59A	610-1140	KIT,BASIC,REPAIR,FU PUMP,FU101 INCLUDES 50, 53, 55, 56, 57 W/F54 OLD STYLE	1
NOT SHOWN	230-1002	FILTER,AIR,INSERT,FOAM,PUMP F,F54 Old Style	1
NOT SHOWN	610-1024	KIT,FILTER,INSERT,PKG OF 6,F PUMP,F54P	1
NOT SHOWN	105-1209	OIL,PUMP,SYNTHETIC,BLUE,1 QUART,ESQ	1