

125-140 IN LBS.
OF TORQUE
(144-161 CM-KG)
4 PLACES

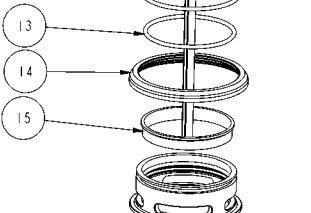

45-55 IN LBS.
OF TORQUE
(52-63 CM-KG)

125-140 IN LBS.
OF TORQUE
(144-161 CM-KG)
4 PLACES

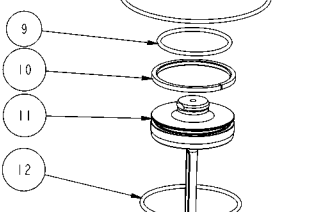
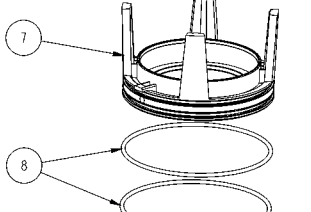
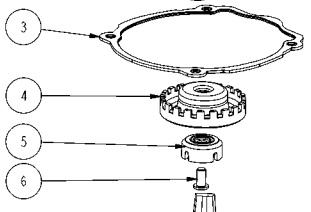
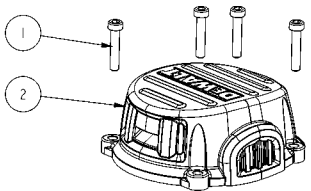
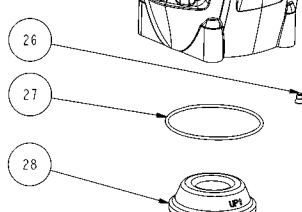
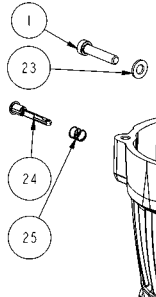

300-330 IN LBS.
OF TORQUE
(346-380 CM-KG)
4 PLACES

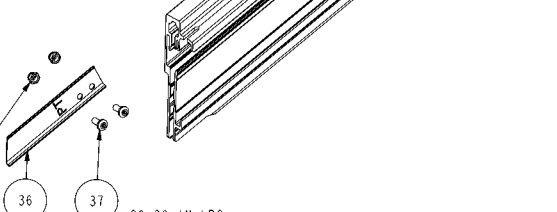
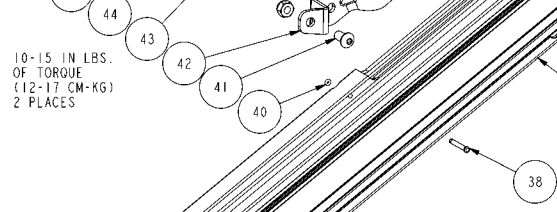
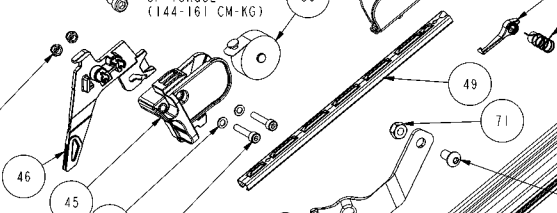
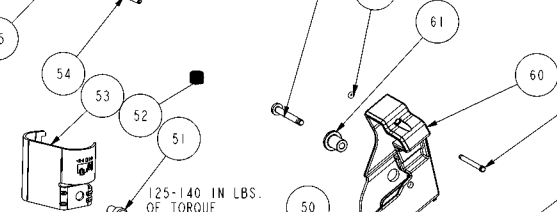
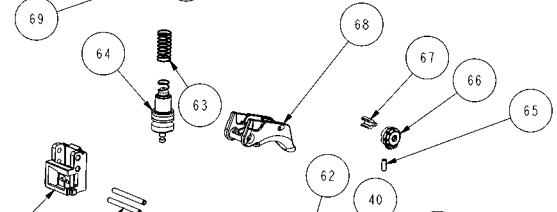
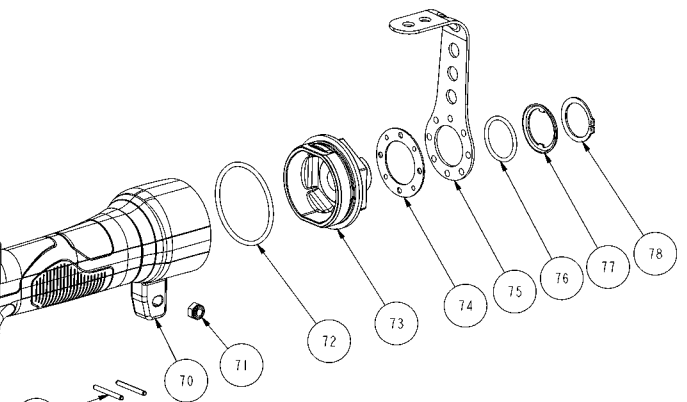
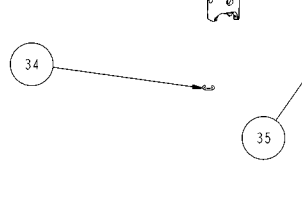
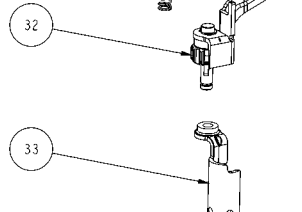
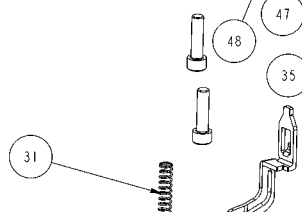
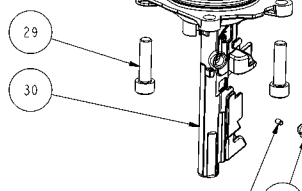

125-140 IN LBS.
OF TORQUE
(144-161 CM-KG)

10-15 IN LBS.
OF TORQUE
(12-17 CM-KG)
2 PLACES

60-70 IN LBS.
OF TORQUE
(69-81 CM-KG)
2 PLACES

20-30 IN LBS.
OF TORQUE
(23-34 CM-KG)
2 PLACES

Parts List for DWF83PT Type 0

Item Number	Part Number	Description	Qty Required
1	MSC6100-30	SCREW-SHCS-M6X1.00X3	5
2	9R208315	CAP	1
3	9R209104	GASKET	1
4	9R208267	EXHAUST BUTTON	1
5	9R198239	PISTON STOP	1
6	9R198240	EXHAUST SCREW	1
7	9R209788	CYLINDER BULKHEAD	1
8	9R209133	O-RING 97.5X2.62MM	2
9	850242	O-RING-1.799X.103	1
10	9R209763	PISTON RING	1
11	F83WWPT-DK	DRIVER KIT	1
12	9R209130	O-RING 63.70X2.62MM	1
13	9R209131	O-RING 57.75X2.62MM	1
14	9R208325	CYLINDER SEAL	1
15	9R198280	CHECK SEAL	1
16	9R208321	CYLINDER	1
17	9R215027	VIBRATION DAMPER	1
18	9R213407	RING RETAINER	1
19	9R209157	O-RING 75.10X2.62MM	1
20	9R209132	O-RING 61.10X2.62	1
21	9R209143	CYLINDER SPRING	1
22	9R208390	BOTTOM RING	1
23	MPW6.3	WASHER-PWN M6	1
24	9R208350	MODE SWITCH PIN	1
25	188850	SPRING	1
26	9R209109	EXHAUST PLUG	1
27	9R208346	O-RING 62.50X2.00MM	1

Parts List for DWF83PT Type 0

Item Number	Part Number	Description	Qty Required
28	F83-BK	BUMPER KIT	1
29	MSC8125-30	SCREW-SHCS M8X30	4
30	9R209796	NOSE F83PT	1
31	9R209138	LOWER CT SPRING	1
32	9R208298	UPPER CONTACT ASSEM	1
33	9R198235	LOWER CONTACT ARM	1
34	9R209147	RETAINER RING	1
35	MHE4070-100	ELASTIC STOP NUT-M4	4
36	9R210322	MAGAZINE PLATE F83PT	1
37	9R195700	SCREW, SFHCS, M4X10	2
38	121407	PIN-SPECIAL	1
39	9R209106	MAGAZINE F83PT	1
40	166797	O-RING-.056X.060 NBR	2
41	MSB6100-12	SCREW-SBHCS-M6X1.00X	2
42	9R209146	MAG. BRACKET F83PT	1
43	180531	SCREW-SHCS-M4X0.70X2	2
44	9R209762	WASHER	2
45	9R209099	PUSHER HANDLE	1
46	9R209160	PUSHER F83PT	1
47	9R208339	MAGNET HOUSING	1
48	9R208338	MAGNET	1
49	121406	LINER-NAIL GUIDE	1
50	F83-CFS	CONSTANT FCE SPRING	1
51	MSC6100-10	SCREW	1
52	9R209790	CONTACT ARM SPRING	1
53	9R208354	TRIP COVER	1
54	106058	PIN-SPRING-M3X32	2

Parts List for DWF83PT Type 0

Item Number	Part Number	Description	Qty Required
55	9R208355	ARM GUIDE	1
56	9R209765	O-RING 2.20X1.60MM	1
57	9R198241	LATCH SPRING	1
58	9R209103	PUSHER LATCH	1
59	9R209141	SPECIAL PIN	1
60	9R209096	MAG. END CAP	1
61	9R209100	PUSHER LATCH SPACER	1
62	9R209764	SPECIAL PIN	1
63	9R198242	TRIGGER SPRING	1
64	TVA20	TRIGGER VALVE ASSY.	1
65	180484	SCREW-SET-M3X8MM	1
66	9R208358	MODE SWITCH BUTTON	1
67	184508	BUSHING	1
68	9R213415	TRIGGER ASSEMBLY	1
69	174345	PIN SPRING	2
70	9R208318	FRAME	1
71	MHE6100-100	NUT-ESN M6X1	3
72	9R208337	O-RING 52.00X3.00MM	1
73	9R208324	END CAP	1
74	9R208291	HOOK SEAT PLATE	1
75	9R208290	HOOK	1
76	174309	O-RING-1.049X.103	1
77	9R188812	CAP-HOOK	1
78	9R208349	C-RING 26MM EXTERNAL	1
876	F83-RK	REBUILD KIT	1