

861

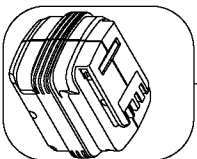

866

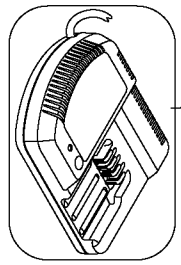

871

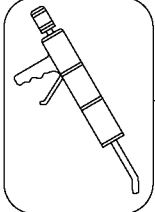

800

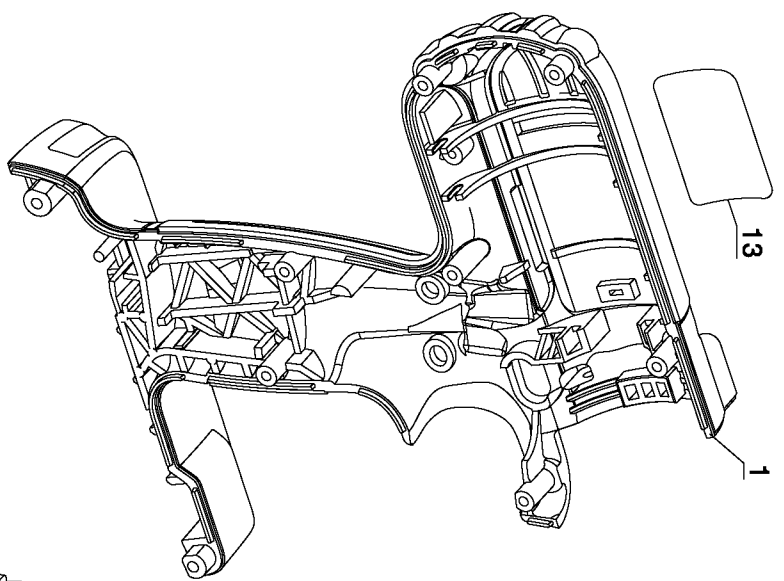

13

1

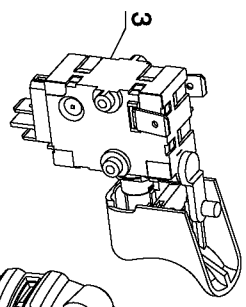

3

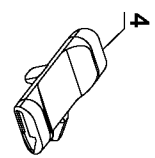

4

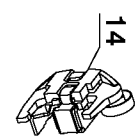

14

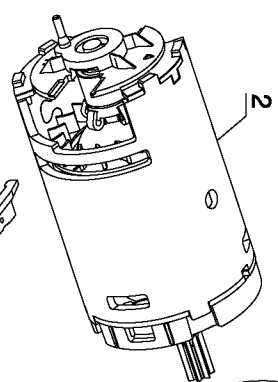

2

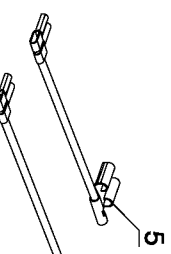
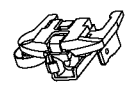

5

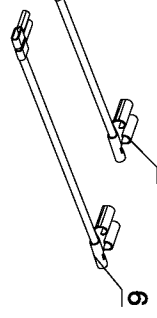

6

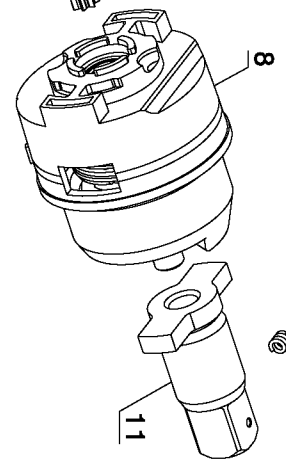

8

11

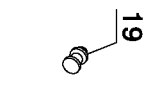

19

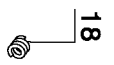

18



17



10

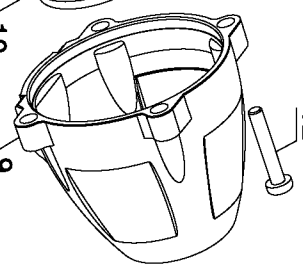

9

12

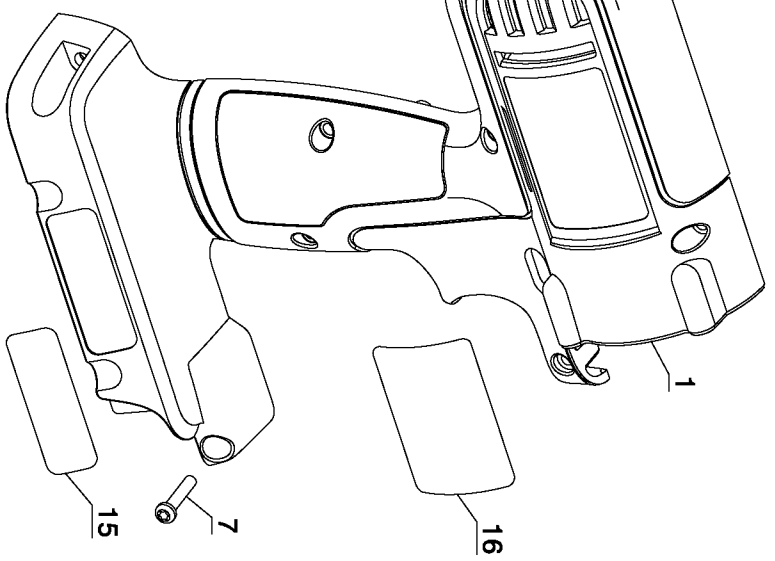

1

15

7

16

Parts List for DC810KL Type 1

Item Number	Part Number	Description	Qty Required
1	640638-01	CLAMSHELL SET	1
2	640641-01	MOTOR&PINION	1
3	640649-02	SWITCH ASSEMBLY	1
4	634728-00	FWD/REV BUTTON	1
5	631282-01	LEADWIRE ASSY.	1
6	631283-00	LEAD WIRE	1
7	682211-00	SCREW,TORX	7
8	640647-00SV	MECHANISM ASSY	1
9	607993-01SV	HOUSING	1
10	605854-01	WASHER	1
11	608024-00SV	ANVIL ASSY.	1
12	330019-52	SCREW PLASTITE	6
13	395657-00	ID LABEL	1
14	389025-04	BRUSH PAIR KIT	1
15	000000-00	No Longer Available	1
16	652805-00	NAMEPLATE	1
17	99205-07	PIN,ROLL	1
18	038769-00	SPRING	1
19	N020802	DETENT PIN	1
800	286436-00	GREASE	1
800	284778-00	GREASE,MOLYKOTE	1
861	652203-00	KITBOX	1
866	DC9280	BATTERY PACK	2
871	DC9000	CHARGER	1