

861

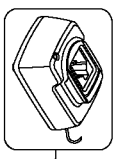

871

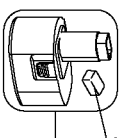

866

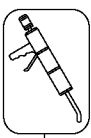

800



856

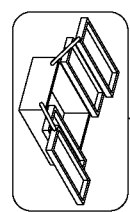

836

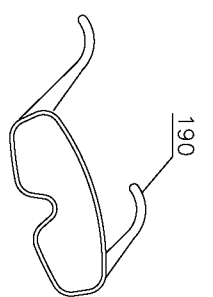

190

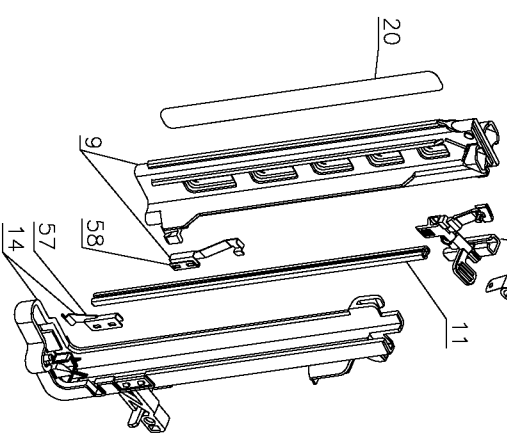

9

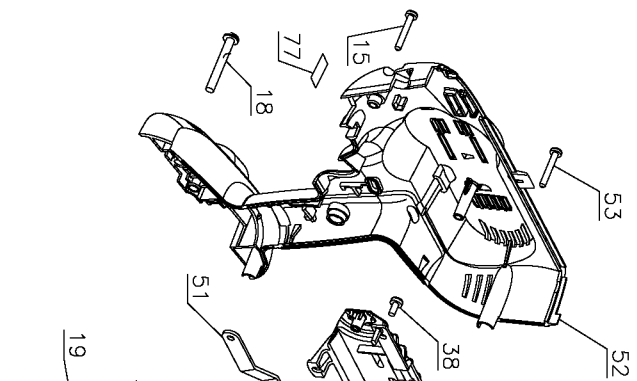

52

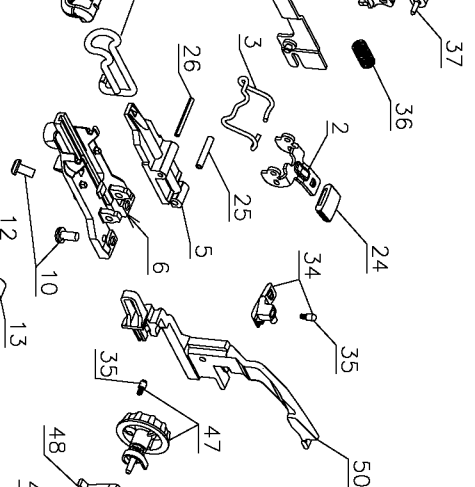

1

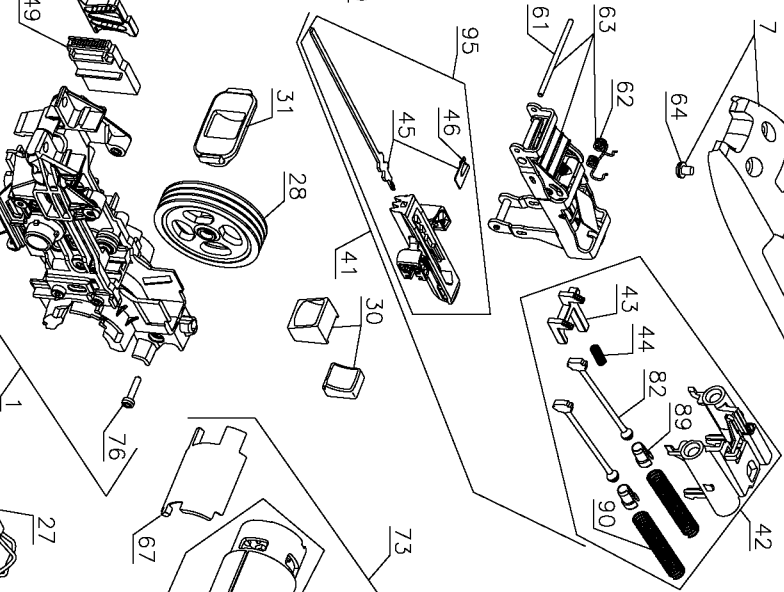

73

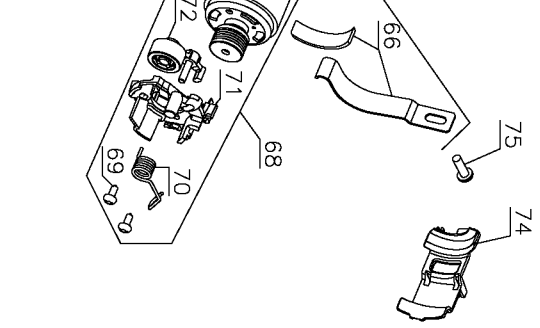

68

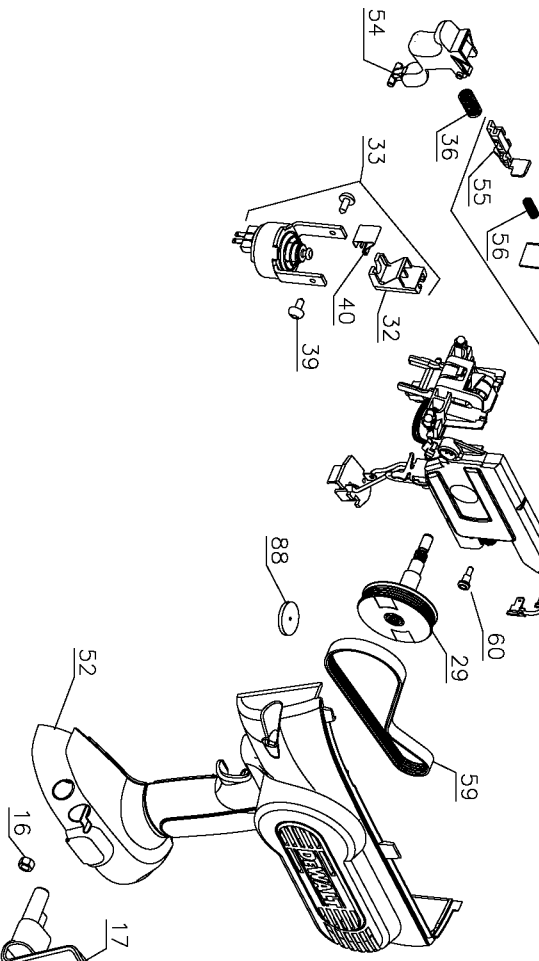

16

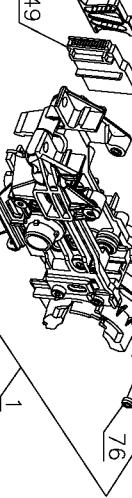

42

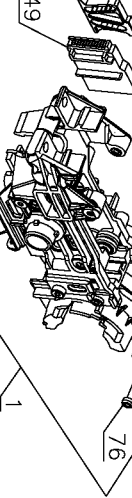

43

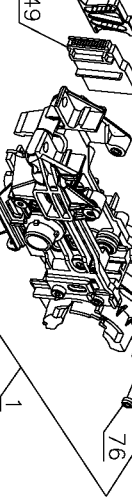

44

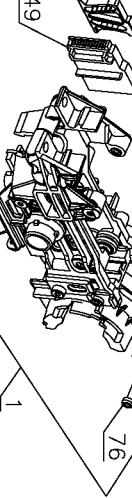

45

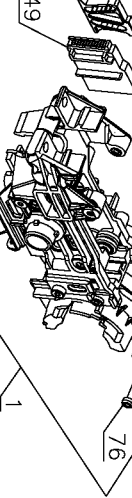

46

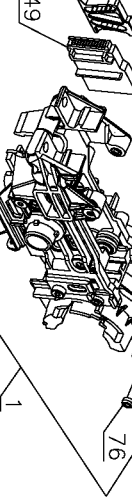

47

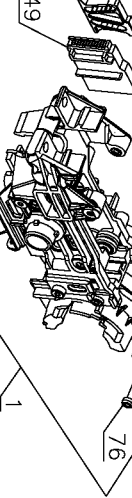

48

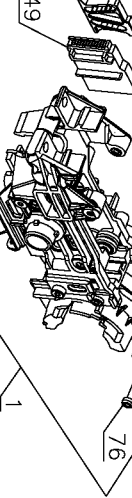

49

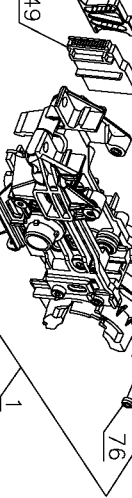

50

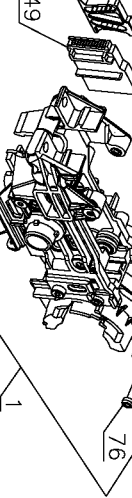

51

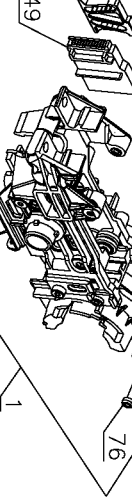

52

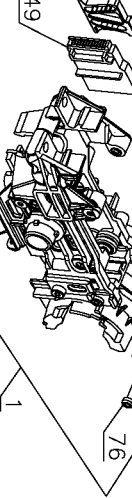

53

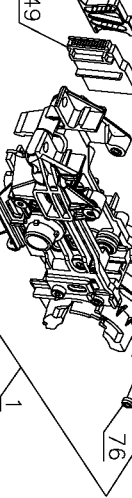

54

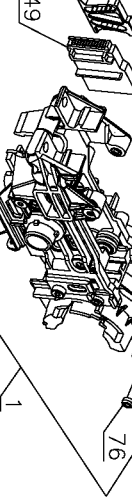

55

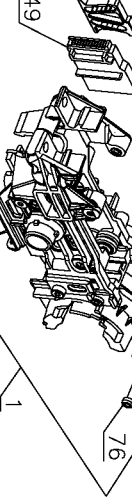

56

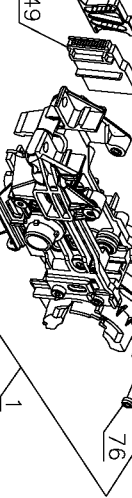

57

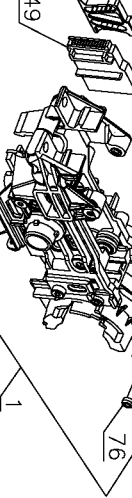

58

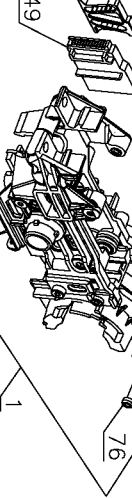

59

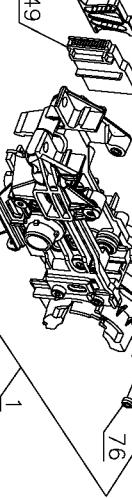

60

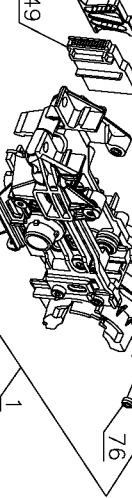

61

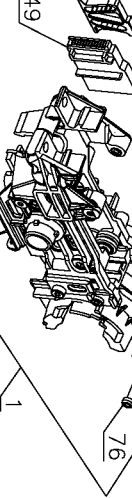

62

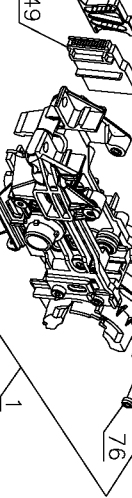

63

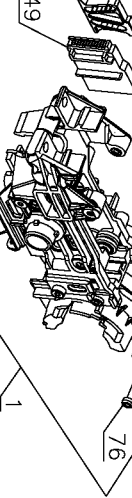

64

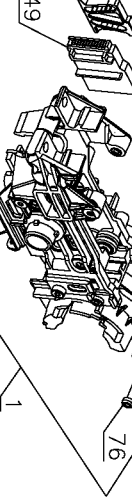

65

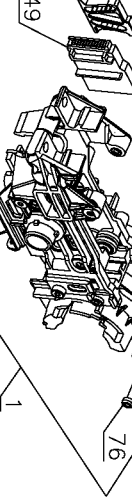

66

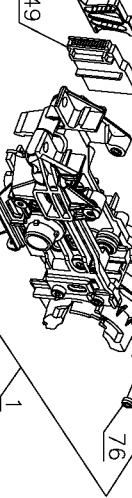

67

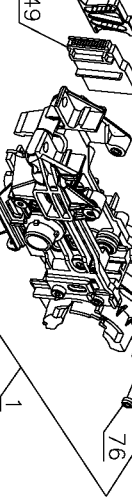

68

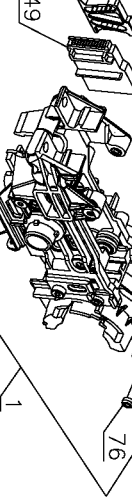

69

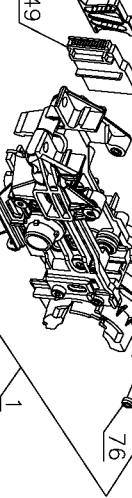

70

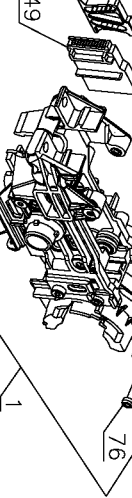

71

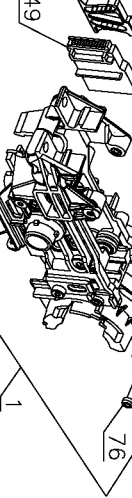

72

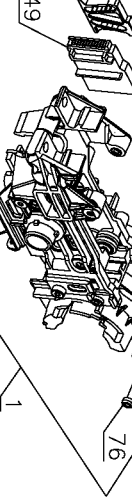

73

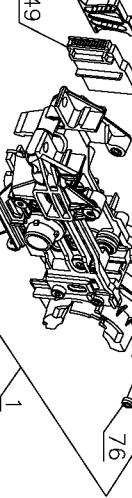

74

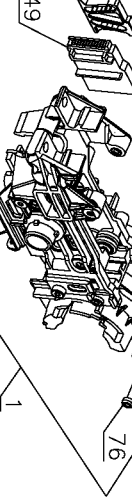

75

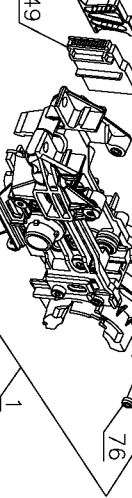

76

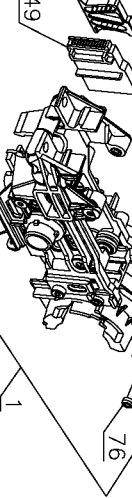

77

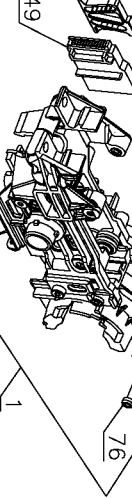

78

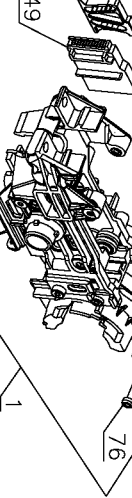

79

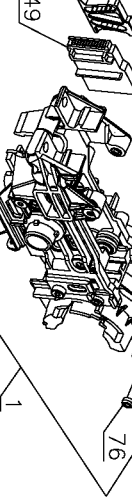

80

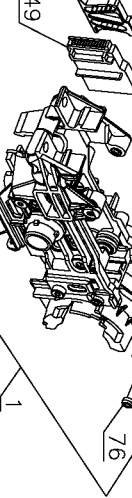

81

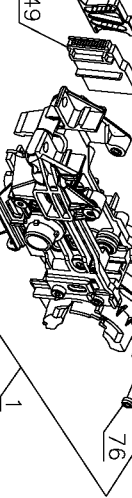

82

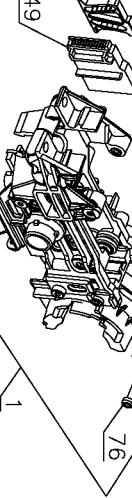

83

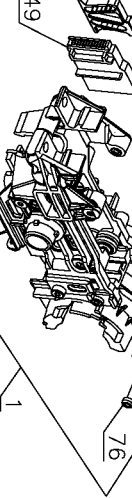

84

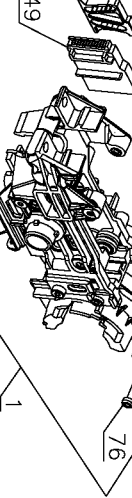

85

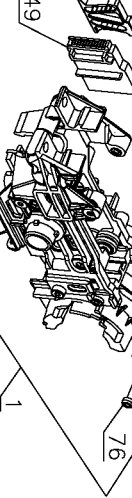

86

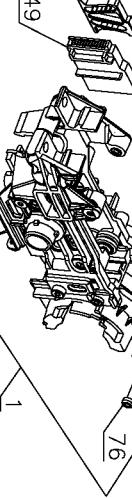

87

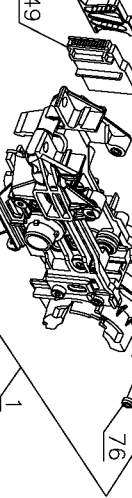

88

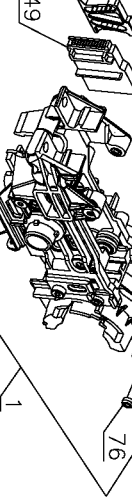

89

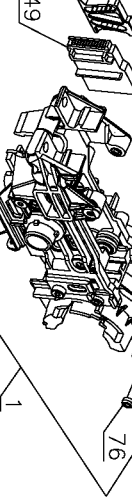

90

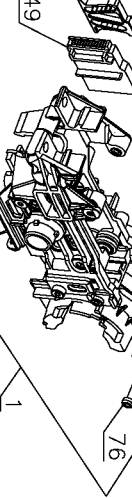

91

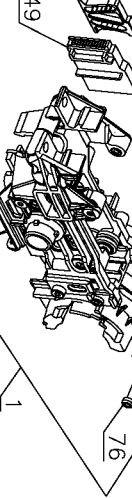

92

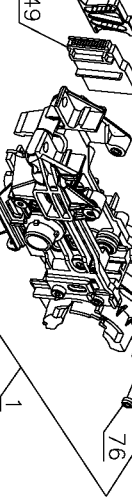

93

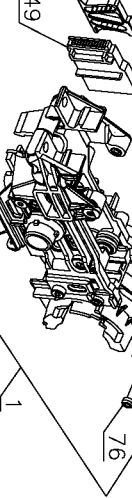

94

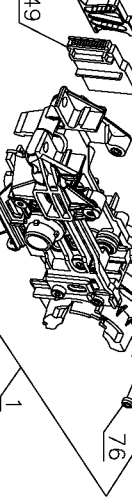

95

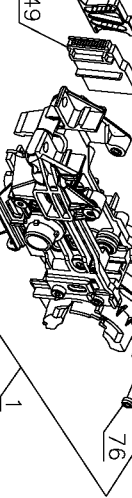

96

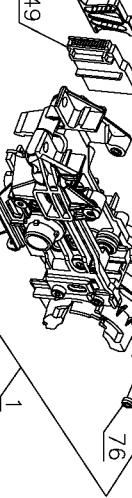

97

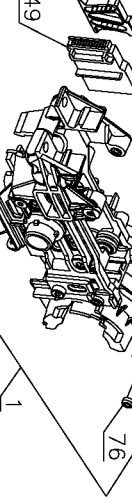

98

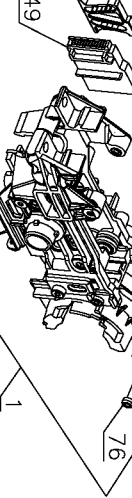

99

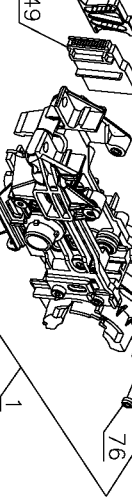

100

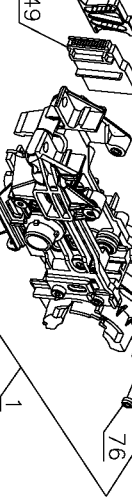

101

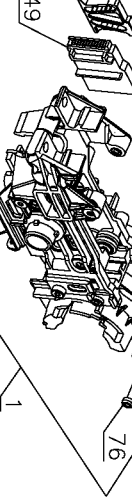

102

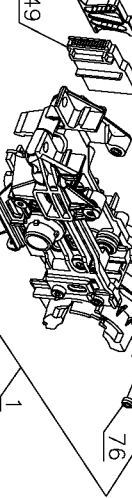

103

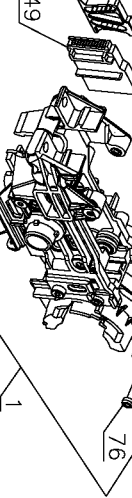

104

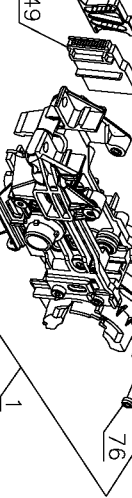

105

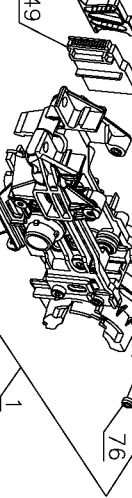

106

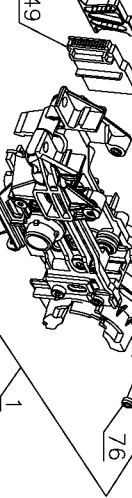

107

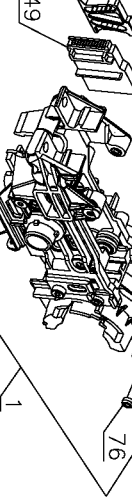

108

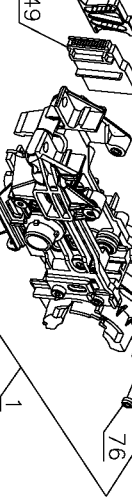

109

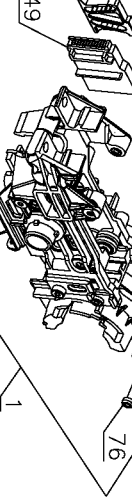

110

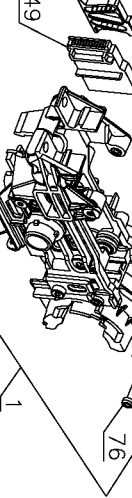

111

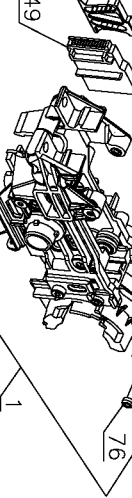

112

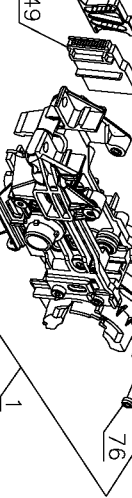

113

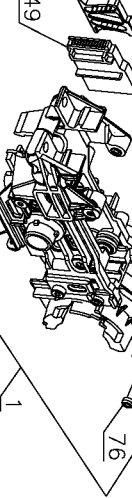

114

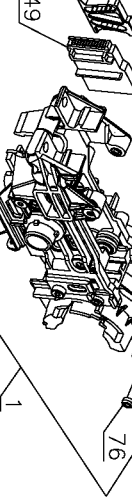

115

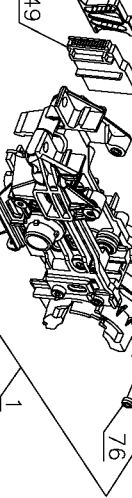

116

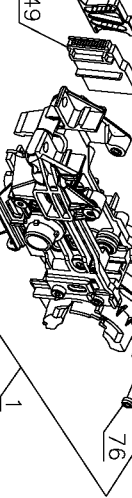

117

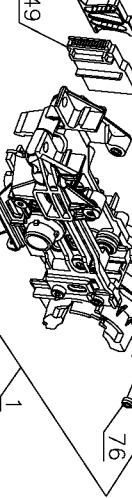

118

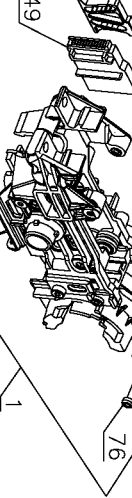

119

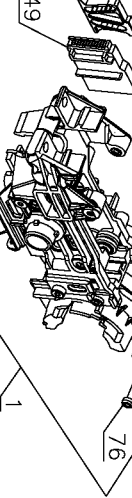

120

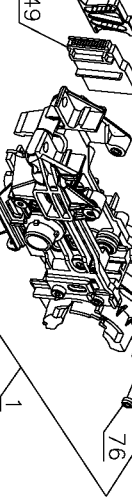

121

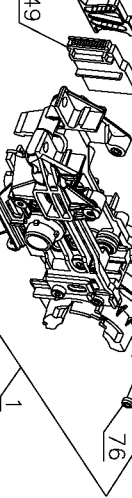

122

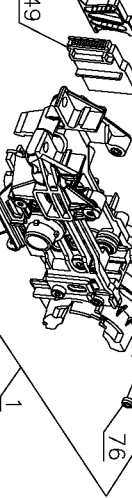

123

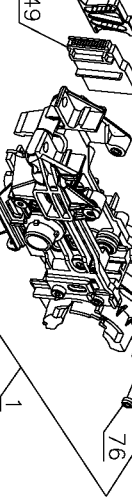

124

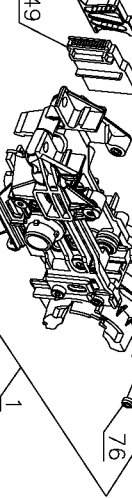

125

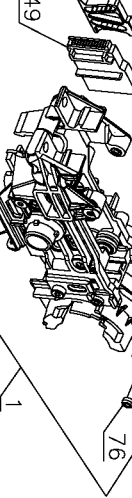

126

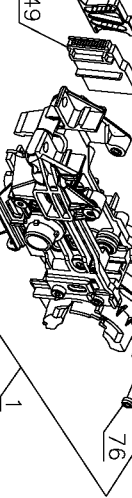

127

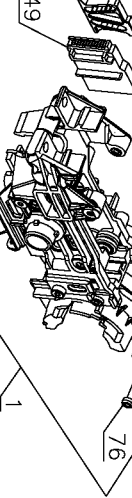

128

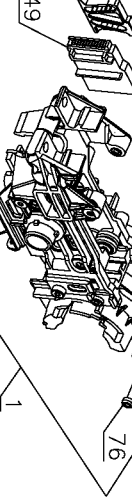

129

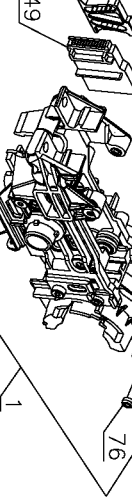

130

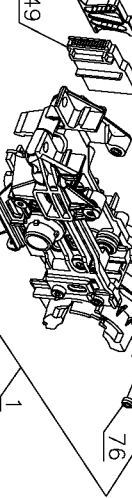

131

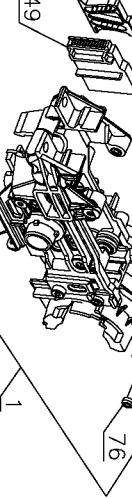

132

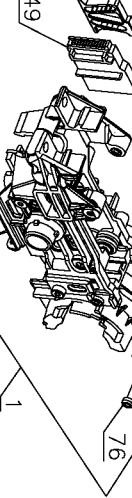

133

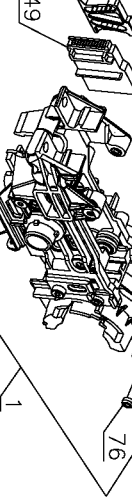

134

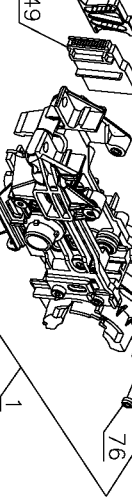

135

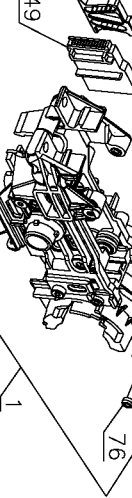

136

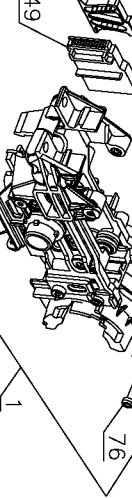

137

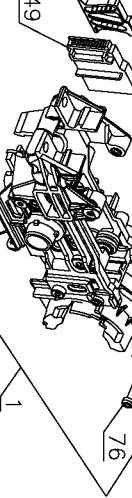

138

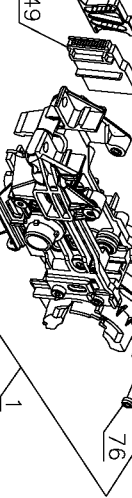

139

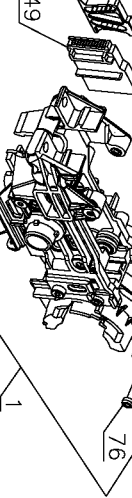

140

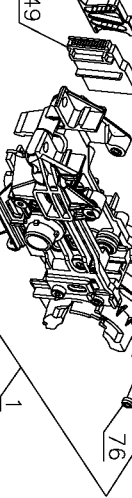

141

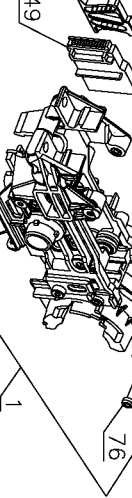

142

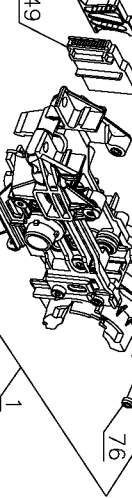

143

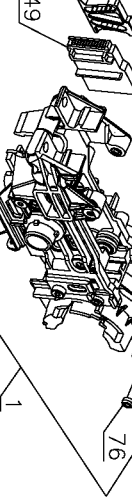

144

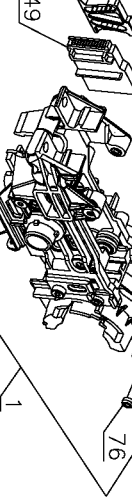

145

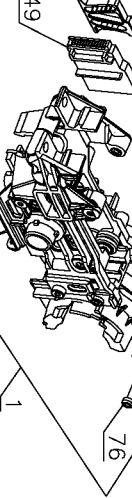

146

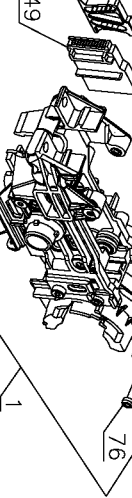

147

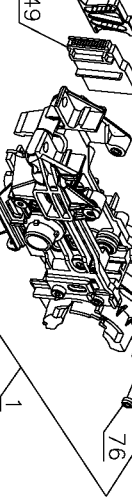

148

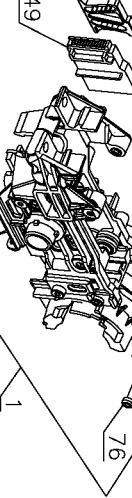

149

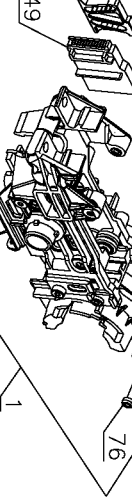

150

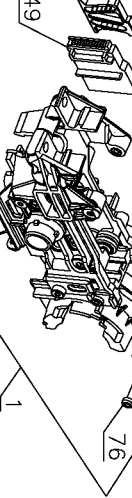

151

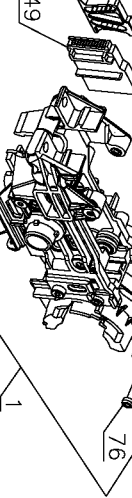

152

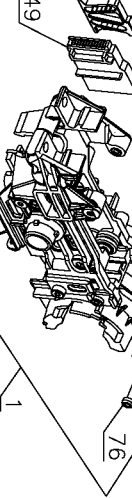

153

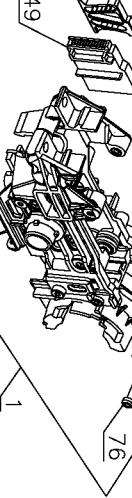

154

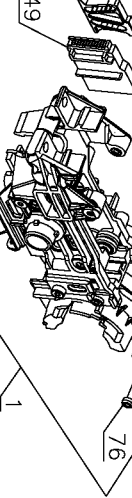

155

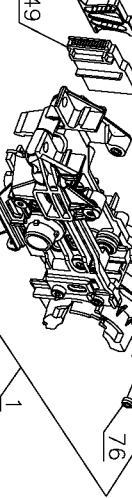

156

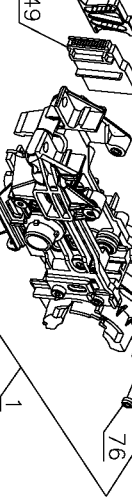

157

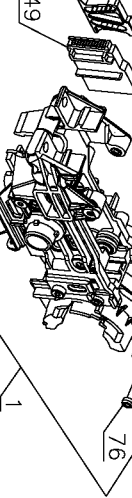

158

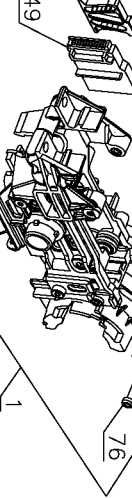

159

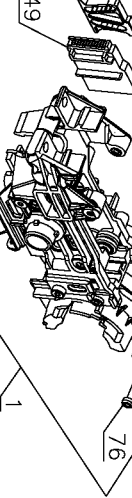

160

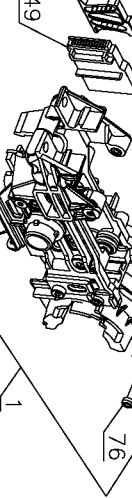

161

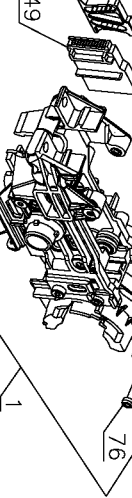

162

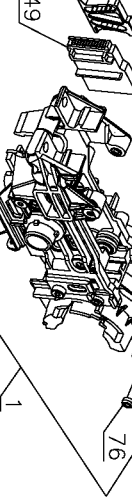

163

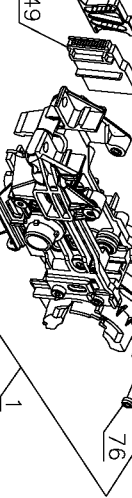

164

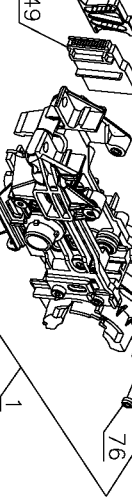

165

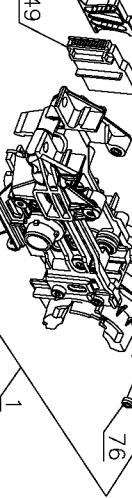

166

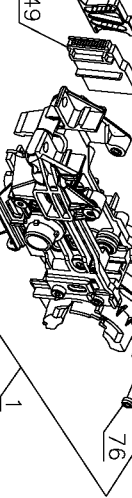

167

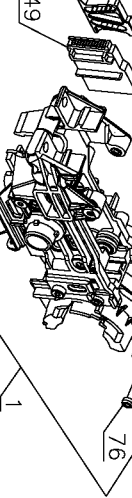

1

Parts List for DC616KN Type 1

Item Number	Part Number	Description	Qty Required
1	613852-00	BACKBONE ASSEMBLY	1
2	395123-00	HANDLE	1
3	392216-00	LATCH	1
4	392198-00	CONTACT TRIP	1
5	392210-00	COVER	1
6	392209-00	NOSEPIECE	1
7	633518-00SV	TOP COVER	1
8	609932-02	SCREW,MACHINE	3
9	392227-01SV	MAGAZINE	1
10	609932-00	SCREW,MACHINE	4
11	392193-01	LINER	1
12	624748-01	PUSHER ASSY.	1
13	392195-00	SPRING	1
14	613818-99	MAGAZINE	1
15	330019-07	SCREW,THD.FORM	1
16	330015-04	NUT,HEX	1
17	394102-00	BELT HOOK	1
18	330045-19	SCREW	2
19	616938-00	NOMAR PAD	1
20	623344-00	NAMEPLATE	1
24	395093-00	COVER/LATCH	1
25	330036-27	ROLL PIN	1
26	330036-21	ROLL PIN	1
27	643115-01	CONTROL MODULE	1
28	623947-00	FLYWHEEL	1
29	613835-00SV	SPINDLE AND PULLEY	1
30	613869-00SV	BUMPER	1

Parts List for DC616KN Type 1

Item Number	Part Number	Description	Qty Required
31	392240-00	BUMPER	1
32	392244-00	CLUTCH	1
33	624709-00SV	SOLENOID ASSY.	1
34	N001917SV	PADDLE ASSY.	1
35	326467-00	DETENT	2
36	653099-00	COMPRESSION SPRING	2
37	604480-00	CAGE	1
38	613619-01	SCREW	5
39	330045-60	SCREW,THD.FORM	2
40	621980-00	CLIP,RETAINING	1
41	392230-01SV	RETURN & PROFILE	1
42	393217-00SV	RETURN DEVICE	1
43	614577-00	STOP	1
44	610243-00	SPRING	1
45	624742-00SV	DRIVER BLADE	1
46	392206-00	CLIP	1
47	613874-00	KNOB DEPTH SET	1
48	392437-00	ADJUSTING PLATE	1
49	392438-00	SLIDER	1
50	393220-00SV	CONTACT TRIP	1
51	396657-00	LINKAGE	1
52	623375-00	CLAMSHELL SET	1
53	330019-05	SCREW,PLASTITE	3
54	613670-00	TRIGGER	1
55	392201-00	LINKAGE	1
56	394314-00	COMPR.SPRING	1
57	392252-00	CLIP	1

Parts List for DC616KN Type 1

Item Number	Part Number	Description	Qty Required
58	392229-00	RETAINER	1
59	392246-00	BELT	1
60	623407-00	SHOULDER SCREW	1
61	395932-00	PIVOT PIN	1
62	394045-00	TORSION SPRING	1
63	624717-00SV	ACTUATION ARM	1
64	330045-12	SCREW	1
66	606837-01	MOTOR STRAP	1
67	623181-00	RUBBER PAD	1
68	613834-00SV	MOTOR ASSEMBLY	1
69	330045-44	SCREW	2
70	604325-00	SPRING	1
71	397762-00	PLATE	1
72	630664-00SV	IDLER ASSEMBLY	1
73	624740-00	MOTOR ASSEMBLY	1
74	628495-00	MOTOR LEAD WIRE GUIDE	1
74	392203-00	MOTOR LEAD WIRE GUIDE	1
75	609932-01	SCREW	1
76	613619-00	SCREW,THD.FORM	5
77	632383-00	LABEL	1
82	392243-00	BAND	2
88	624913-00	DISC	1
89	392242-00	STOP	2
90	392236-02	SPRING	2
95	392204-00SV	PROFILE & DRIVER	1
190	629042-01	SAFETY GLASSES	1
800	5140024-25	GREASE	1

Parts List for DC616KN Type 1

Item Number	Part Number	Description	Qty Required
836	000000-00	No Longer Available	1
836	233823-01	SOLENOID PULLER	1
836	233823-00	GAP GAUGE	1
856	625336-01	DIAGNOSTICS CD	1
856	625336-00	DIAGNOSTICS CD	1
861	633527-00	KITBOX	1
861	623488-00	LID CARD	1
866	DC9096	BATTERY PACK	1
867	645221-00	BATTERY CAP	1
871	388683-12	1 HOUR CHARGER	1