

0 601 672 039  
Issue | 15-88  
Stand | 07-01-31

**Fig./Abb. 1**

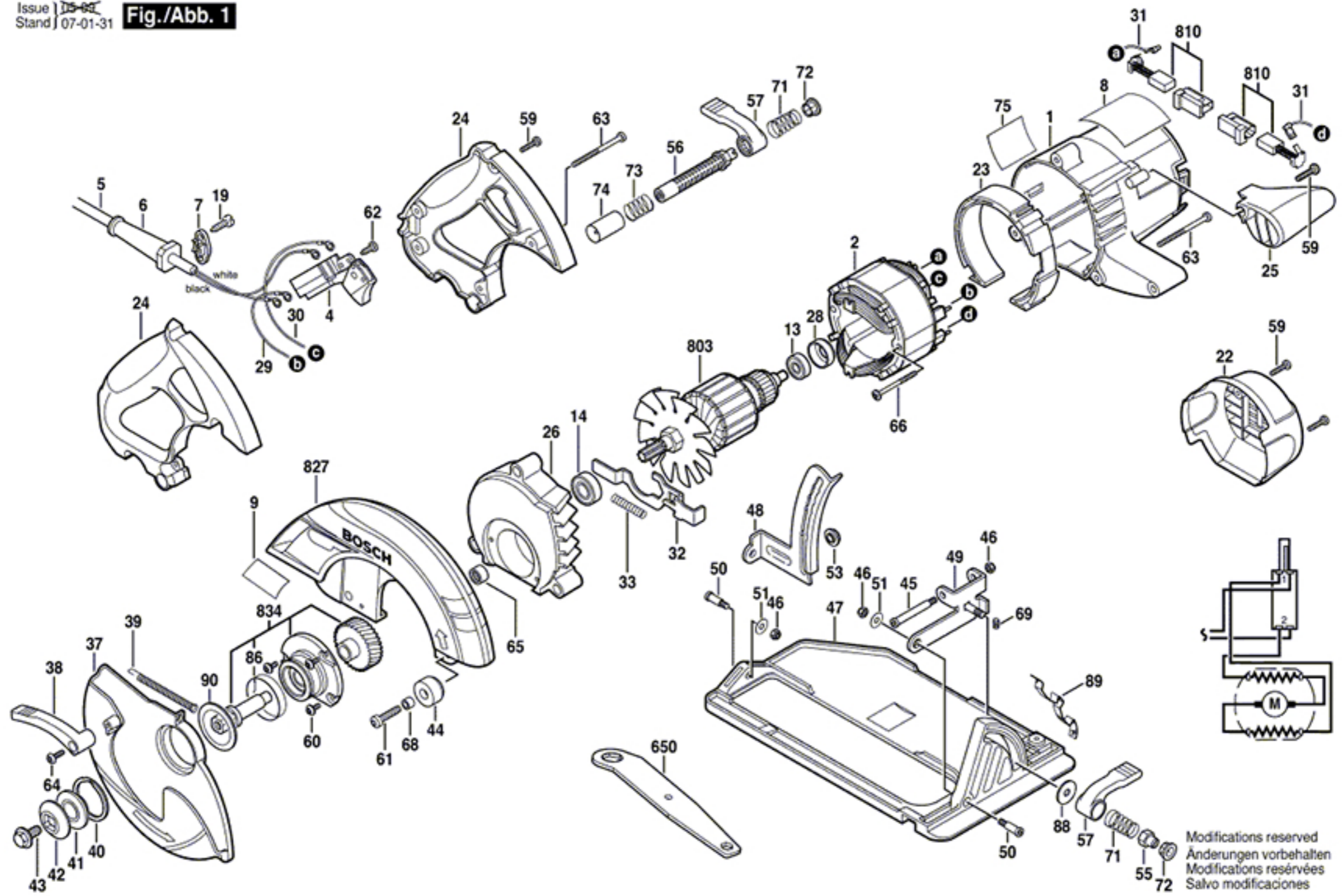

Modifications reserved  
Änderungen vorbehalten  
Modifications réservées  
Salvo modificaciones