

WARNING
TO PREVENT RISK OF BLAST FROM UNEXPECTED SAFETY INSTRUCTIONS SUPPLIED WITH TOOL.
TO AVOID BLAST THE OPERATOR MUST WEAR PROTECTIVE GEAR. ALWAYS WEAR SAFETY GLASSES AND HEARING PROTECTION.

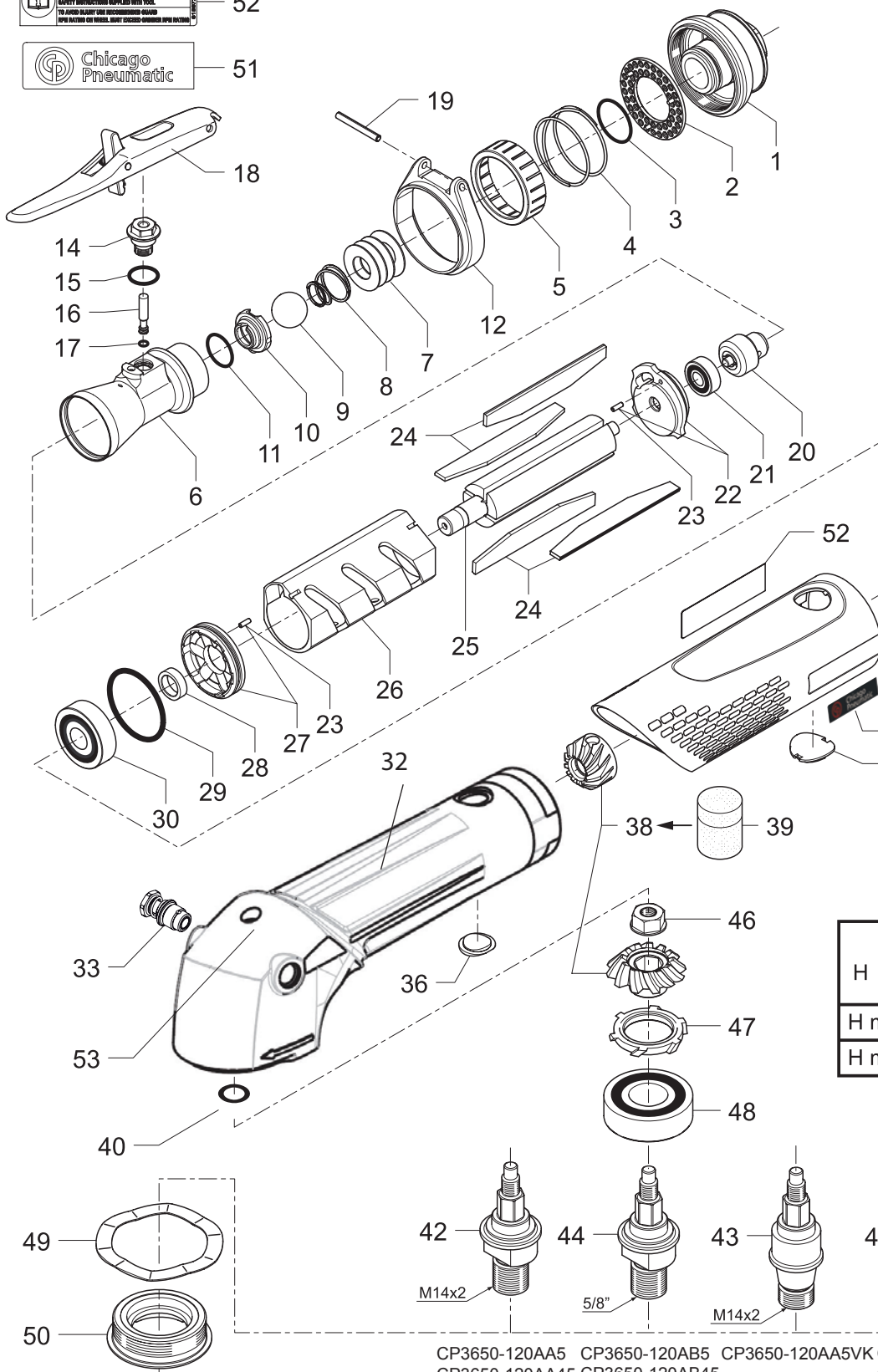

*** Tightening direction**
Sens de serrage
Sentido de apriete
Anziehrichtung
Senso di serraggio
Sentido de aperto
Kivistysuunta
Åtdragningsriktning
Tilstrammingsretning
Tilspændingsretning
Schroefrichtung
Φορά σύσφιξης
上紧方向
Meghúzás iránya
Pievilksšanas virziens
Kierunek dokręcania
Směr utahování
Smer uťahovania
Smer zatesnjevanja
Sukimo kryptis
Направление затяжки

	*	
b) 50 / 32		60 Nm
b) 33 / 32		3 Nm
c) 20 / 25		2 Nm
a) 13 / 6		3 Nm
d) 1 / 32		30 Nm
46 / 42		30 Nm
46 / 43		30 Nm
46 / 44		30 Nm
46 / 45		30 Nm
38 / 25		30 Nm

a) : "Loctite 222"
b) : "Loctite 243"
c) : "Loctite 641"
d) : "Loctite 270"

H	mm
H maxi	10.85
H mini	9.8

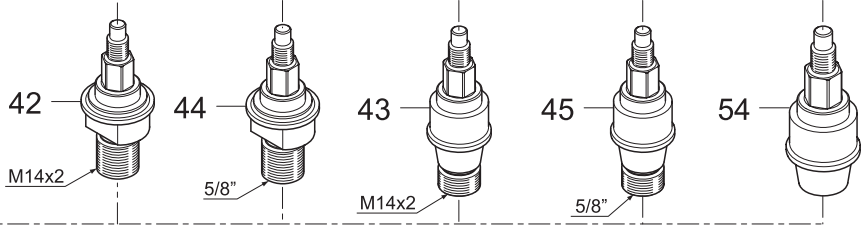

CP3650-120AA5 CP3650-120AB5 CP3650-120AA5VK CP3650-120AB5VK CP3650-120AH5VK
CP3650-120AA45 CP3650-120AB45 CP3650-100B6VK

	rpm
CP3650-120AA5/CP3650-120AA45/CP3650-120AB5/CP3650-120AB45/ CP3650-120AA5VK/CP3650-120AB5VK/CP3650-100B6VK	12000
CP3650-100AB6VK	10000

Index No.	Part No.	Description	Qty.	Index No.	Part No.	Description	Qty.
A	2050556023	Silencer Kit		J	2050556073	Motor Bearing Kit	
2		Silencer	1	30		Bearing	1
3		O-Ring	1	21		Bearing	1
5		Valve	1	K	2050556013	Small parts kit	
B	6153967360	Bushing Complete		46		Nut	1
14		Bushing	1	47		Deflector	1
15		O-Ring	1	23		Pin	1
16		Pin	1	19		Pin	1
17		O-Ring	1	4		Spring Cylindrical	1
C	2050556033	Valve Kit		1	6153967390	Adapter	1
8		Spring Conical	1	6	6154300330	Inlet	1
9		Ball	1	7	6156452290	Disc Spring	1
10		Valve seat	1	12	6155960040	Lever Bracket	1
11		O-Ring	1	18	6153967350	Safety lever	1
D	2050556043	Rear Endplate Kit		20	6154570490	Governor 19K (CP3650-120AA5VK / CP3650-120AB5VK / CP3650-120AH5VK / CP3650-120AA5 / CP3650-120AB5 / CP3650-120AA45 / CP3650-120AB45)	1
21		Bearing	1	20	6154570490	Governor 16K (CP3650-100AB6VK)	1
22		Rear Endplate	1	25	6154261200	Rotor	1
E	2050556063	Blades Kit		26	6154001480	Cylinder	1
24		Blade	4	41	501.71	Shaft Hexa	
F	2050556053	Front Endplate Kit		54	6155011330	Shaft Hexa for autobalancer	
27		Front Endplate	1	42	501.87	Shaft M14	1
28		Plate Spacer	1	43	6155011250	Shaft M14 for autobalancer	1
29		O-Ring	1	44	501.88	Shaft 5/8"	1
30		Bearing	1	45	6155011260	Shaft 5/8" for autobalancer	1
G	6153933320	Housing Complete Kit 12000RPM		49	6156451720	Washer	1
32		Housing	1	50	6156731510	Plug (CP3650-120AA5VK / CP3650-120AB5VK / CP3650-120AA5 / CP3650-120AB5)	1
33	6153974060	Stopfinger Complete	1	50	6156731500	Plug (CP3650-120AH5VK)	1
53		Greaser	1	L	2050556003	Tune Up Kit	
31		Insulator 12000RPM	1		2050556063	Blade Kit	1
37		External cover	1	3		O-Ring	1
51		Left side brand name plate	1	11		O-Ring	1
52		Warning label	1	15		O-Ring	1
36		Cover	1	17		O-Ring	1
1		Adaptater	1	29		O-Ring	1
39	396.001	Grease Kit - 5g	1				
H	399.480	Bevel Gear paired set					
38		Bevel gear	1				
39		Grease Kit - 5g	1				
I	2050556083	Output Bearing Kit					
40		Bearing	1				
46		Nut	1				
47		Deflecotr	1				
48		Bearing	1				

	6159948760	SAFETY INSTRCUTIONS GRINDERS
	2050554963	OPERATOR'S MANUAL
	2050554983	EC DECLARATION GRINDER

ACCESSORIES INCLUDED

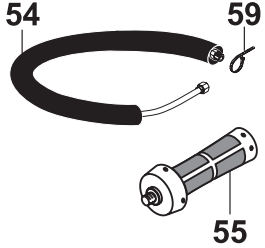
CP3650-120AA5VK / CP3650-120AB5VK / CP3650-120AH5VK / CP3650-100AB6VK	Item	Part Number	Qty	Description
	54	6153961660	1	Silencer kit (59)
	55	6155760660	1	Vibration-damping side handle
	59	6152630240	2	Hose clamp

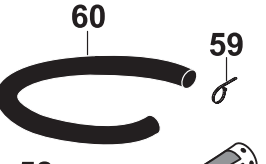
CP3650-120AA5 / CP3650- 120AB5 / CP3650-120AA45 / CP3650-120AB45	Item	Part Number	Qty	Description
	58	6157040270	1	3/8" air hose nipple for 1/2" (13mm) ID hose
	59	6152630240	2	Hose clamp
	60	6158751130	1	Exhaust hose
	55	6155760660	1	Vibration-damping side handle

Type 27-42 and 1 wheel

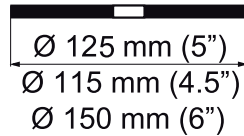
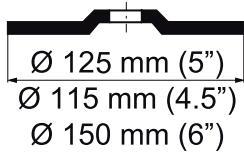
 Flap wheels
 with depressed centre wheels



The tools 6" and 5" could not be used with a wheel adaptor or a built-in hub wheel

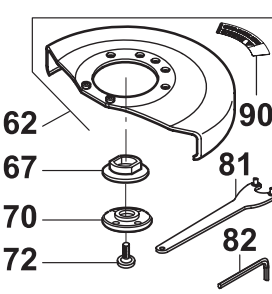

CP3650-100B6VK	Item	Part Number	Qty	Description
	63	6155042020	1	Multi-position guard 6" for autobalancer (\varnothing 150mm) (With warning label 90)
	69	6159901810	1	Autobalancer
	71	6155020670	1	Front flange
	72	6156140760	1	Safety screw
	81	6158020100	1	Pin wrench 1-3/8" (35mm)
	82	6158020570	1	Hexagon wrench 1/4" A/F (6,35mm)
	90	6158727910	1	Warning guard Label
	91	6156451420	2	Washer
	92	6156110320	2	Screw

CP3650-120AA5 / CP3650-120AA45	Item	Part Number	Qty	Description
	62	6155041970	1	Multi-position guard 5" (\varnothing 125mm) (With warning label 90) CP3650-120AA5
	62	6155041980	1	Multi-position guard 4,5" (\varnothing 115mm) (With warning label 90) CP3650-120AA45
	67	6155031340	1	Rear flange
	70	6155020660	1	Front flange
	72	6156140760	1	Safety screw
	81	6158020100	1	Pin wrench 1-3/8" (35mm)
	82	6158020570	1	Hexagon wrench 1/4" A/F (6,35mm)
	90	6158727910	1	Warning guard Label

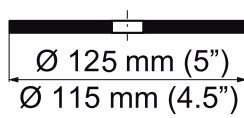
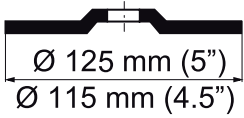
Type 27-42 and 1 wheel



Flap wheels
with depressed centre wheels

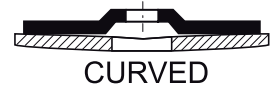
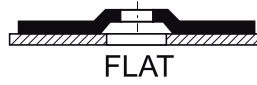

The tools 6" and 5" could not be used with a wheel adaptor or a built-in hub wheel

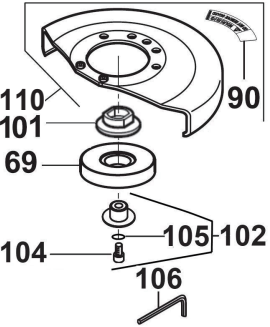

CP3650-120AH5VK	Item	Part Number	Qty	Description
	110	6155042240	1	Multi-position guard 5" for autobalancer (Ø125mm) (With warning guard label 90)
	69	6159901940	1	Autobalancer
	101	6155031640	1	Rear Flange
	102	6155020850	1	Front Flange Complete (With Lock screw 104 and Ring Snap 105)
	90	6158727910	1	Warning Guard Label
	104	6156161290	1	Lock Screw
	105	6156900440	1	Ring Snap RB14
	106	6158020560	1	Hexagon Wrench 6MM A/F

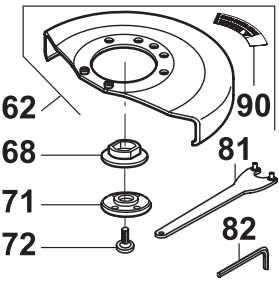
CP3650-120AB5 / CP3650-120AB45	Item	Part Number	Qty	Description
	62	6155041970	1	Multi-position guard 5" (Ø125mm) (With warning label 90) CP3650-120AB5
	62	6155041980	1	Multi-position guard 4,5" (Ø115mm) (With warning label 90) CP3650-120AB45
	68	6155031410	1	Rear flange
	71	6155020670	1	Front flange
	72	6156140760	1	Safety screw
	81	6158020100	1	Pin wrench 1-3/8" (35mm)
	82	6158020570	1	Hexagon wrench 1/4" A/F (6,35mm)
	90	6158727910	1	Warning guard Label

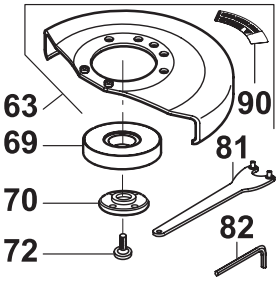
CP3650-120AA5VK	Item	Part Number	Qty	Description
	63	6155041930	1	Multi-position guard 5" for autobalancer (Ø125mm) (With warning label 90)
	69	6159901810	1	Autobalancer
	70	6155020660	1	Front flange
	72	6156140760	1	Safety screw
	81	6158020100	1	Pin wrench 1-3/8" (35mm)
	82	6158020570	1	Hexagon wrench 1/4" A/F (6,35mm)
	90	6158727910	1	Warning guard Label

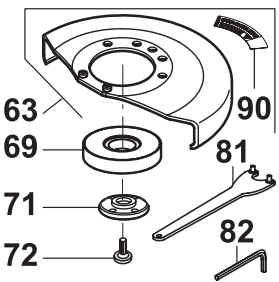
CP3650-120AB5VK	Item	Part Number	Qty	Description
	63	6155041930	1	Multi-position guard 5" for autobalancer (Ø125mm) (With warning label 90)
	69	6159901810	1	Autobalancer
	71	6155020670	1	Front flange
	72	6156140760	1	Safety screw
	81	6158020100	1	Pin wrench 1-3/8" (35mm)
	82	6158020570	1	Hexagon wrench 1/4" A/F (6,35mm)
	90	6158727910	1	Warning guard Label

OPTIONAL ACCESSORIES

Optional	Item	Part Number	Qty	Description
	54	6153961660	1	Silencer kit
	55	6155760660	1	Vibration-damping side handle
	59	6152630240	1	Hose clamp
	73	6153969570	1	Clippable silencer
	74	6158751160	1	Reinforced cloth-lined exhaust hose L=30" (0.75mm)
	76	6159901490	1	Grease gun include 24g
	77	6159901480	1	Grease for bevel gear (1kg)
	78	6154340640	1	Blades kit (x100)

Dust extraction kit for diamond disc Ø5" (125mm)

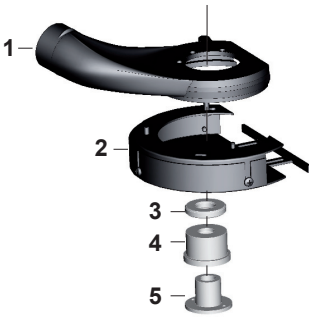
Optional	Item	Part Number	Qty	Description
		6153992810	1	Complete kit
	1	6155042170	1	Manifold cutting with screws
	2	6155042180	1	Goble cover plate complete
	3	6156430920	1	Spacer 6mm - Hole 14mm
	3	6156430910	1	Spacer 6mm - Hole 16mm
	4	6156430890	1	Spacer for M14 spindle
	4	6156430900	1	Spacer for 5/8" spindle
	5	6156060460	1	Flange nut M14
	5	6156060450	1	Flange nut 5/8"
	.	6158020670	1	Pin key