

CP3339/CP3349 Vertical Grinders

6159945170
Issue no: 02
Series: C

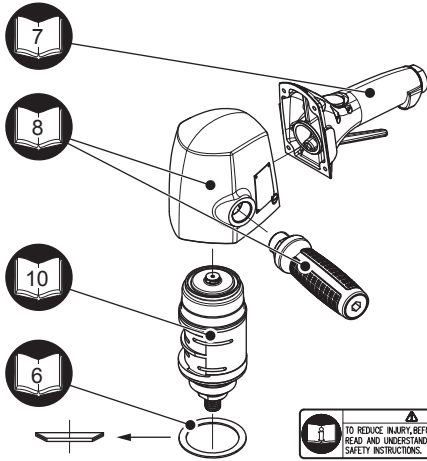

Model	Ref.	Model	Ref.
CP3349-SALAVAD	6151609050	CP3339-SALAVET	6151609040
CP3349-SALAVETE	6151609150	CP3349-SALAVELE	6151609130
CP3349-SALAVADE	6151609110	CP3349-SALAVEL	6151609070
CP3349-SALAVET	6151609080	CP3339-SALAVELE	61516091020
CP3339-65E	6151620140		
CP3339-SALAVADE	6151609100		
CP3339-SALAVAD	6151609010		
CP3339-SALAVEL	6151609030		

WARNING
TO REDUCE INJURY, BEFORE USING OR SERVICING TOOL, READ AND UNDERSTAND SEPARATELY PROVIDED SAFETY INSTRUCTIONS.

WARNING
RPM RATING ON WHEEL MUST EXCEED GRINDER RPM RATING



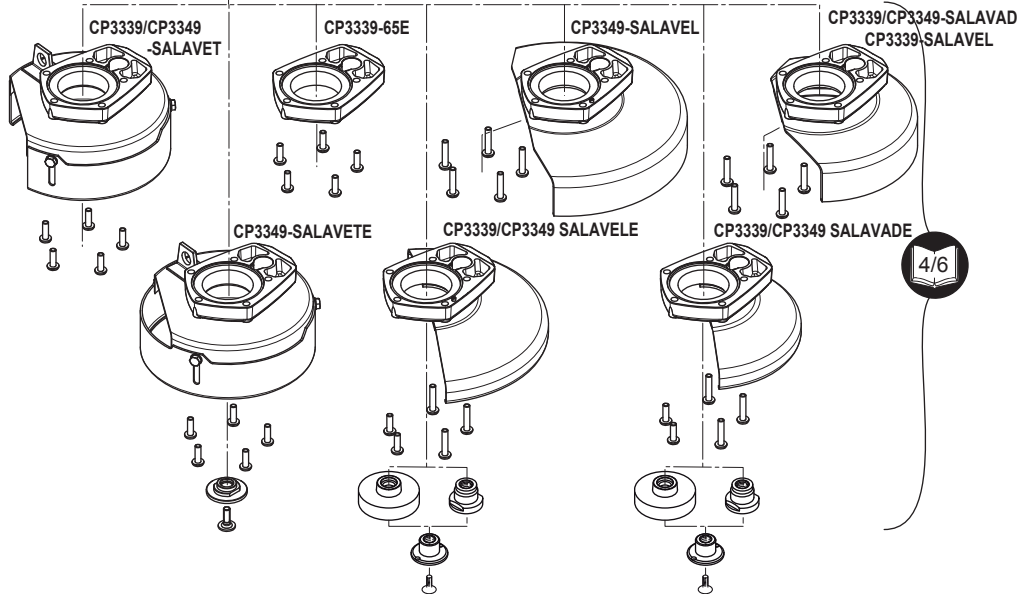

WARNING
Do not operate without wheel guard







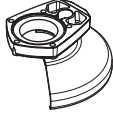

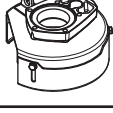
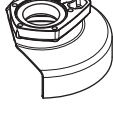
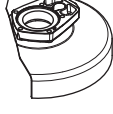

US	CP3349-SALAVAD	CP3339-SALAVAD	CP3349-SALAVEL CP3349-SALAVET	CP3339-SALAVET CP3339-SALAVEL
rpm	7700	7700	6000	6000
hp (W)	3.75 (2800)	3.21 (2400)	3.62 (2700)	3.00 (2200)

CE	CP3349-SALAVADE	CP3349-SALAVELE	CP3339-65E CP3339-SALAVELE	CP3349-SALAVETE	CP3339-SALAVET
rpm	7700	6500	6500	6000	6000
hp (W)	3.75 (2800)	3.62 (2700)	3.00 (2200)	3.62 (2700)	3.00 (2200)



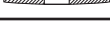











6159945170 Issue no: 02 Series: C	CP3339/CP3349 Vertical Grinders
---	---------------------------------

		CP3339 -65E	CP3349 -SALAVETE	CP3339 -SALAVADE CP3349 -SALAVADE	CP3349 -SALAVELE	CP3339 -SALAVET CP3349 -SALAVET	CP3339 -SALAVAD CP3339 -SALAVEL CP3349 -SALAVAD	CP3349 -SALAVEL
6156452200 	Spacer complete	1						
6155041810 	Complete guard 6" CE		1					
6155041820 	Complete guard 7" CE			1				
6155041830 	Complete guard 9" CE				1			
6155041780 	Complete guard 6" US					1		
6155041790 	Complete guard 7" US						1	
6155041800 	Complete guard 9" US							1

CP3339/CP3349 Vertical Grinders	6159945170 Issue no: 02 Series: C
---------------------------------	---

	CP3349 -SALAVETE	CP3339 -SALAVADE CP3349 -SALAVADE	CP3349 -SALAVELE	CP3339 -SALAVET CP3349 -SALAVET	CP3339 -SALAVAD CP3339 -SALAVEL CP3349 -SALAVAD	CP3349 -SALAVEL
Type 6 	6" - Ø150			6" - Ø150		
Type 11 	6" - Ø150			6" - Ø150		
Type 27-42 		7" - Ø180	9" - Ø230		7" - Ø180	9" - Ø230
Type 41 		7" - Ø180	9" - Ø230		7" - Ø180	9" - Ø230
Type A 		7" - Ø180	9" - Ø230		7" - Ø180	9" - Ø230
Type B 		7" - Ø180	9" - Ø230		7" - Ø180	9" - Ø230
Type 27-42 					7" - Ø180	9" - Ø230
Type 41 					7" - Ø180	9" - Ø230
Type A 					7" - Ø180	9" - Ø230
Type B 					7" - Ø180	9" - Ø230

6159945170 Issue no: 02 Series: C	CP3339/CP3349 Vertical Grinders
---	---------------------------------

	CP3349 65E	CP3349 -SALAVETE	CP3339 -SALAVADE CP3349 -SALAVADE	CP3349 -SALAVELE CP3339 -SALAVELE	CP3339 -SALAVET CP3349 -SALAVET	CP3339 -SALAVAD CP3339 -SALAVEL CP3349 -SALAVAD	CP3349 -SALAVEL
6155031160  Rear flange		1					
6155031030  Rear flange			1	1			
6155031460  Rear flange balancer							
6155421040  Nut			1	1			
6156140340  Screw		1	1	1		1	1
6156101050  Screw	5	5	2	2	5		
6156101070  Screw			3	3		5	5
6158010770  Spanner flat		1	1	1		1	1
6158020100  Pin spanner			1	1			
6158020560  Hex. wrench 6mm		1	1	1		1	1
6158020610  Hex. wrench 8mm					1		
6155952020  Lever					1		
6156080490  Nut					1	1	1
6156452180  Spring washer	1	1	1	1	1	1	1

HANDLE COMPLETE

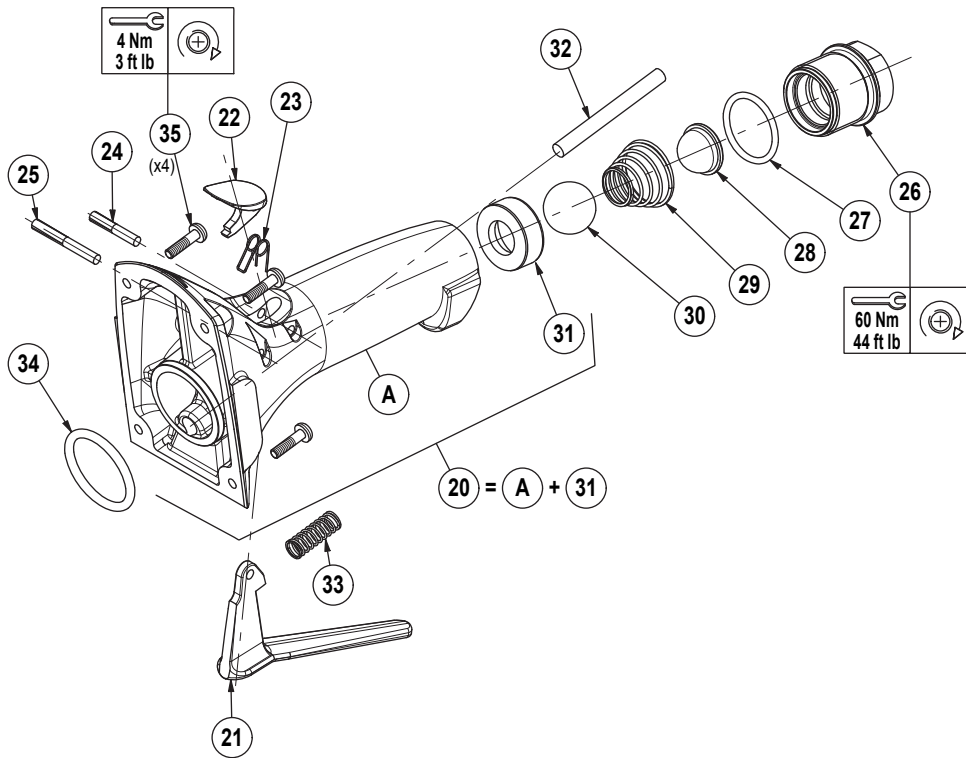

20	Handle kit	6153965650
21	Lever	6153210830
22	Latch lever	6153212140
23	Latch lever spring	6156811210
24	Grooved pin	6156380140
25	Grooved pin	6156380150
26	Bushing inlet	6157460740
27	O ring	6156581150
28	Screen	744.08
29	Ball spring	6156810200
30	Ball	6157700190
31	Ball seat	6153210800
32	Needle	6157901350
33	Lever spring	6156811230
34	O ring	6156583160
35	Screw	6156100930

HOUSING COMPLETE

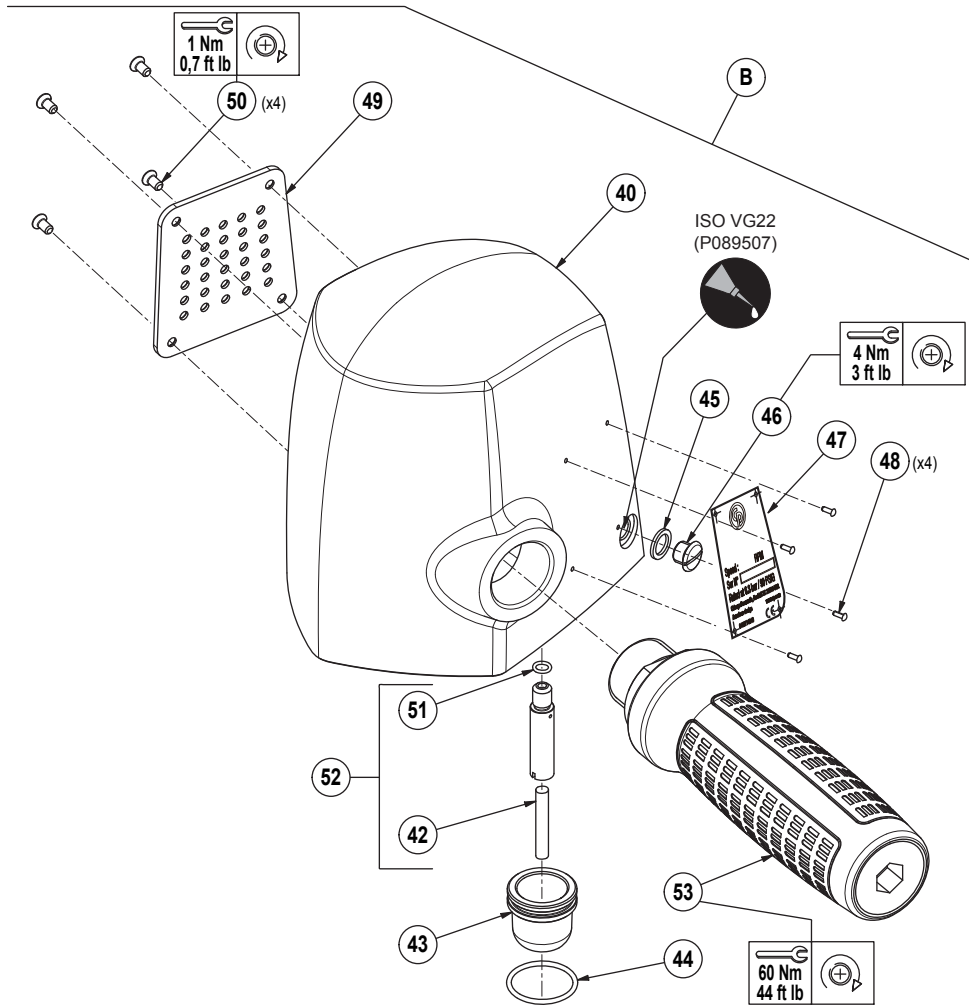

CP3339/CP3349 Vertical Grinders

6159945170
Issue no: 02
Series: C

		CP3339 -SALAVADE CP3339 -SALAVAD	CP3349 -SALAVELE	CP3339 -SALAVELE	CP3349 -SALAVETE CP3349 -SALAVET	CP3339 -65E
B	Housing complete	6153932660	6153932680	6153932690	6153932720	6153932730
40	Housing	6155652820	6155652840	6155652850	6155652860	6155652870
42	Felt	6156540400				
43	Oil tank down	6153212320				
44	O ring	658.120				
45	Washer	6156500250				
46	Oil plug	6156140270				
47	Tool label	6158727470				
48	Grooved nail	6156340220				
49	Exhaust grid	6155740560				
50	Screw	6156180180				
51	O ring	6156582620				
52	Oil tank up complete	6153212310				
53	Side handle complete	6155760720				

		CP3339 -SALAVET CP3339 -SALAVEL	CP3339 -SALAVADE	CP3339 -SALAVAD	CP3349 -SALAVEL
B	Housing complete	6153932740	6153932750	6153932760	6153932770
40	Housing	6155652880	6155652890	6155652900	61556529100
42	Felt	6156540400			
43	Oil tank down	6153212320			
44	O ring	658.120			
45	Washer	6156500250			
46	Oil plug	6156140270			
47	Tool label	6158727470			
48	Grooved nail	6156340220			
49	Exhaust grid	6155740560			
50	Screw	6156180180			
51	O ring	6156582620			
52	Oil tank up complete	6153212310			
53	Side handle complete	6155760720			

MOTOR COMPLETE

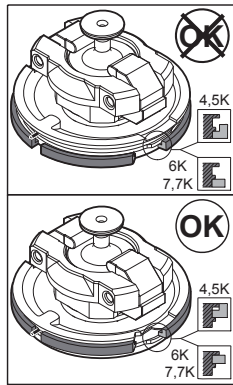

H (mm)	CP3339		CP3349	
	inch	mm	inch	mm
H maxi	0.906	23	0.783	19,9
H mini	0.827	21	0.705	17,9

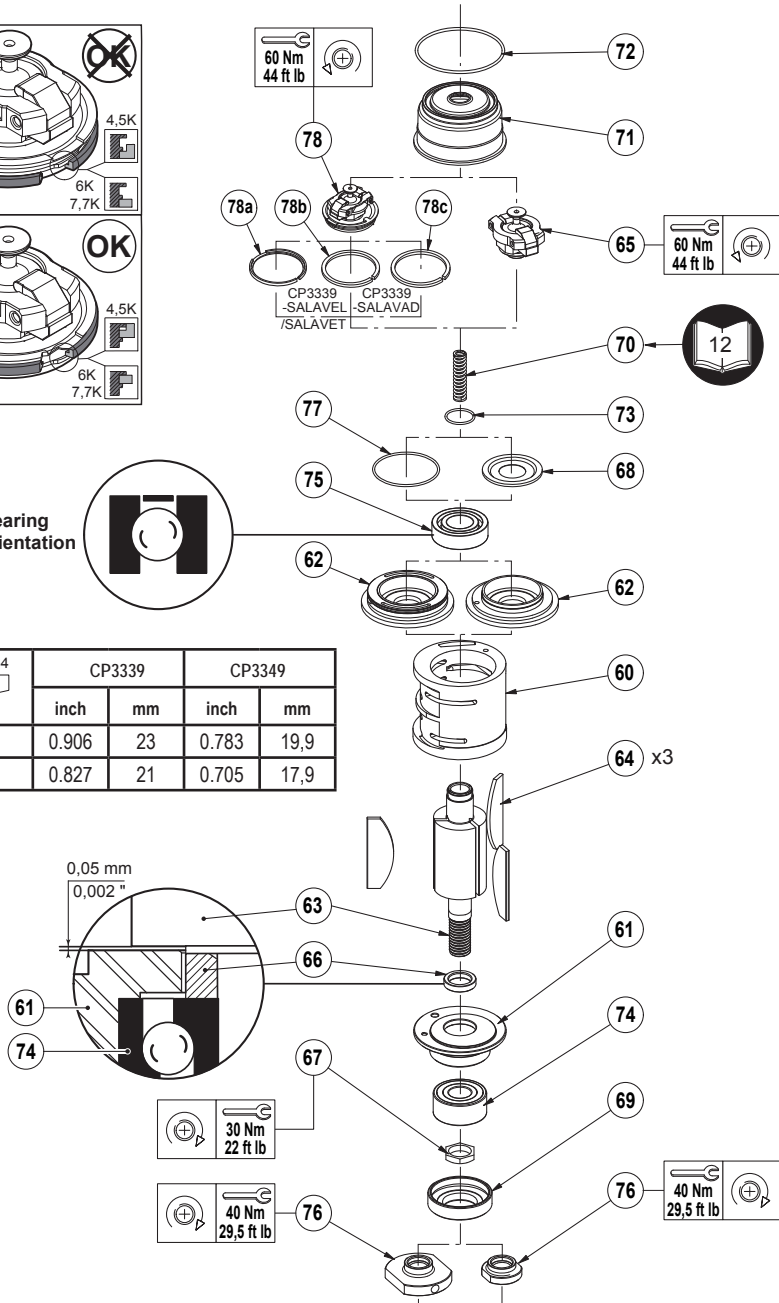

CP3339/CP3349 Vertical Grinders

6159945170
Issue no: 02
Series: C

		CP3339 -SALAVADE	CP3339 -SALAVELE	CP3339 -SALAVAD	CP3339 -SALAVEL CP3339 -SALAVET
60	Cylinder	400.112	400.112	400.112	400.112
61	Front plate	420.115	420.115	420.115	420.115
62	End plate	422.120	422.120	6154221500	6154221500
63	Rotor	426.65	426.65	6154261050	6154261050
64	Vane	434.42	434.42	434.42	434.42
65	Governor	457.18	457.18	/	/
66	Spacer	661.75	661.75	661.75	661.75
67	Nut	607.49	607.49	607.49	607.49
68	Flange	557.93	557.93	/	/
69	Plug	673.68	673.68	673.68	673.68
70	Spring	681.34	681.33	6156811050	6156811040
71	Governor housing	6153211830	6153211830	6153211830	6153211830
72	O ring	658.118	658.118	658.118	658.118
73	O ring	658.120	658.120	658.120	658.120
74	Bearing	754.17	754.17	754.17	754.17
75	Bearing	758.17	758.17	758.17	758.17
76	Rear flange	/	/	6155031500	6155031500
77	O ring	/	/	6156581240	6156581240
78	Governor	/	/	6154570330	6154570320
78a	Ring overspeed	/	/	/	/
78b	Ring overspeed	/	/	/	6153201280
78c	Ring overspeed	/	/	6153201290	/

		CP3349 -SALAVELE	CP3349 -SALAVAD	CP3349 -SALAVADE	CP3349 -SALAVETE CP3349 -SALAVET	CP3339 -65E	CP3349 -SALAVETE
60	Cylinder	400.120	400.120	400.120	400.120	400.112	400.120
61	Front plate	420.119	420.119	420.119	420.119	420.115	420.119
62	End plate	422.129	6154221490	422.129	6154221490	422.120	422.129
63	Rotor	426.62	6154261030	426.62	6154261030	426.65	426.62
64	Vane	434.48	434.48	434.48	434.48	434.42	434.48
65	Governor	457.18	/	457.18	/	457.18	457.18
66	Spacer	661.75	661.75	661.75	661.75	661.75	661.75
67	Nut	607.49	607.49	607.49	607.49	607.49	607.49
68	Flange	557.93	/	557.93	/	557.93	557.93
69	Plug	673.68	673.68	673.68	673.68	673.68	673.68
70	Spring	681.33	6156811050	6156811050	6156811040	681.33	6156511040
71	Governor housing	6153211830	6153211830	6153211830	6153211830	6153211830	6153211830
72	O ring	658.118	658.118	658.118	658.118	658.118	658.118
73	O ring	658.120	658.120	658.120	658.120	658.120	658.120
74	Bearing	754.17	754.17	754.17	754.17	754.17	754.17
75	Bearing	758.17	758.17	758.17	758.17	758.17	758.17
76	Rear flange	/	6155031500	/	6155031500	6155031070	/
77	O ring	/	6156581240	/	6156581240	/	/
78	Governor	/	6154570330	/	6154570320	/	/
78a	Ring overspeed	/	/	/	/	/	/
78b	Ring overspeed	/	/	/	6153201280	/	/
78c	Ring overspeed	/	6153201290	/	/	/	/

6159945170 Issue no: 02 Series: C	CP3339/CP3349 Vertical Grinders		
 70		Governor Spring (1)	
CP3339-SALAVADE	681.34	8500 rpm	Red (2)
CP3339-SALAVAD / CP3349-SALAVAD CP3349-SALAVADE	6156811050	7700 rpm	Black (3)
CP3339-65E / CP3339-SALAVELE / CP3349-SALAVELE	681.33	6500 rpm	Uncolored (4)
CP3339-SALAVEL / CP3339-SALAVET / CP3349-SALAVEL / CP3349-SALAVET / CP3349-SALAVETE	6156811040	6000 rpm	Orange (5)

- FR** (1) Ressort de régulateur, (2) Rouge, (3) Noir, (4) Incolore, (5) Orange, (6) Violet
- ES** (1) Ressorte de regulador, (2) Rojo, (3) Negro, (4) Incoloro, (5) Naranja, (6) Violeta
- DE** (1) Feder des Reglers, (2) Rot, (3) Schwartz, (4) Ungefärbt, (5) Orange, (6) Veilchenblau
- IT** (1) Molla di regolatore, (2) Rosso, (3) Nero, (4) Incolore, (5) Arancione, (6) Viola
- PT** (1) Mola de regulador, (2) Vermelho, (3) Negro, (4) Incolor, (5) Laranja, (6) Violeta
- FI** (1) Säätöjousi, (2) Punainen, (3) Musta, (4) Väriltön, (5) Oranssi, (6) Purppura
- SV** (1) Regulatorfjäder, (2) Röd, (3) Svart, (4) Ofärgad, (5) Orange, (6) Lila
- NO** (1) Regulatorfjær, (2) Rød, (3) Svart, (4) Ufarget, (5) Oransje, (6) Lilla
- DA** (1) Regulatorfjeder, (2) Rød, (3) Sort, (4) Ufarvet, (5) Orange, (6) Lilla
- NL** (1) Regulateurveer, (2) Rood, (3) Zwart, (4) Kleurloos, (5) Oranje, (6) Paars
- EL** (1) Ελατήριο ρυθμιστή, (2) Κόκκινο, (3) Μαύρο, (4) Αχρωμο, (5) Πορτοκαλί, (6) Βιολέ
- CN** (1) 调节器弹簧, (2) 红色, (3) 黑色, (4) 无色, (5) 橙色, (6) 紫色
- HU** (1) Szabályozó rugó, (2) Piros, (3) Fekete, (4) Színtelen, (5) Narancs, (6) Ibolya
- LV** (1) Regulatora atspere, (2) Sarkana, (3) Melna, (4) Bezkrāsaina, (5) Oranža, (6) Violeta
- PL** (1) Sprężyna regulatora, (2) Czerwony, (3) Czarny, (4) Bezbarwny, (5) Pomarańczowy, (6) Fioletowy
- CZ** (1) Pružina regulátoru, (2) Červená, (3) Černá, (4) Bezbarvá, (5) Oranžová, (6) Fialová
- SK** (1) Spružina regulátora, (2) Červená, (3) Čierna, (4) Bezfarebná, (5) Oranžová, (6) Fialová
- SL** (1) Vzmet regulatorja, (2) Rdeča, (3) Črna, (4) Brezbarvno, (5) Oranžna, (6) Vijolična
- LT** (1) Regulatoriaus spyruoklė, (2) Raudona, (3) Juoda, (4) Bespalvė, (5) Oranžinė, (6) Violetinė
- RU** (1) Пружина регулятора, (2) Красный, (3) Черный, (4) Бесцветный, (5) Оранжевый, (6) Фиолетовый

Locking and unlocking the grinding wheel
Montage et démontage de la meule

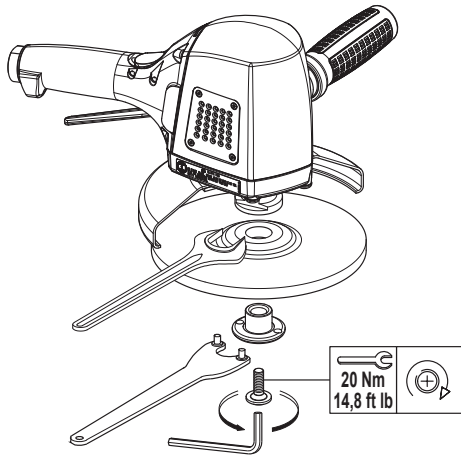

Start procedure
Mise en route



Free speed control
Contrôle de la vitesse à vide

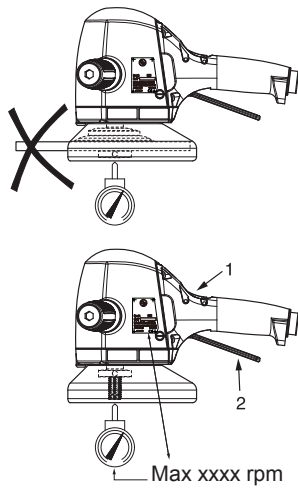

Filter cleaning
Nettoyage du filtre

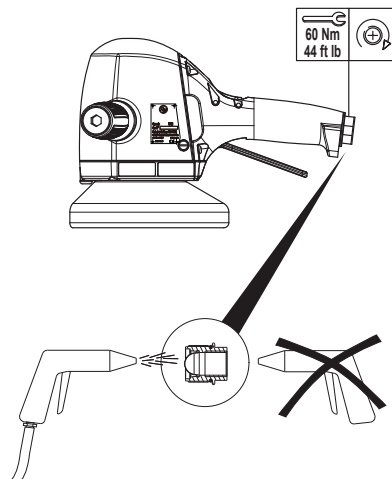

6159945170 Issue no: 02 Series: C	CP3339/CP3349 Vertical Grinders
---	---------------------------------

OPTIONAL ACCESSORIES

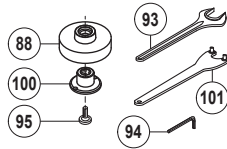

88	Rear flange balancer	6155031460
93	Spanner flat	6158010770
94	Hexagon wrench	6158020560
95	Screw	6156140340
100	Nut	6155421040
101	Pin spanner 35mm	6158020100

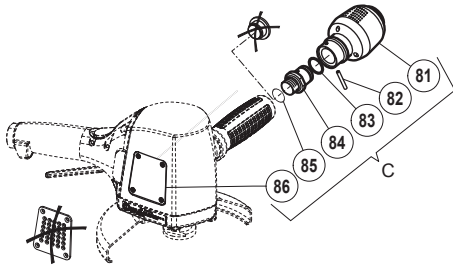

C	Silencer assembly	399.463
81	Silencer	399.736
82	Pin	637.50
83	O ring	658.164
84	Bushing	730.172
85	O ring	658.246
86	Gasket	6155740570

CP3339-SALAVEL / CP3339-SALAVET /
CP3339-SALAVAD / CP3349-SALAVEL /
CP3349-SALAVET / CP3349-SALAVAD

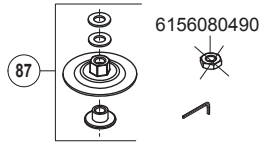

Type 27 and 42

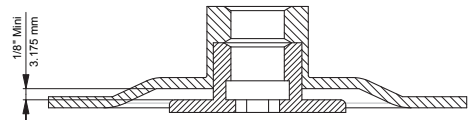

87	Wheel adapter	C087920
----	---------------	---------

Type 27 - 41 and 42

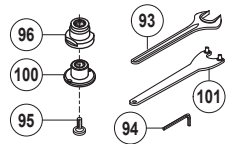
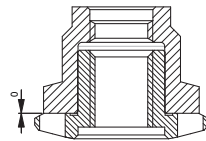

93	Spanner flat	6158010770
94	Hexagon wrench 6mm	6158020560
95	Screw	6156140340
96	Rear flange	6155031030
100	Nut	6155421040
101	Pin spanner 35mm	6158020100

CP3339/CP3349 Vertical Grinders	6159945170 Issue no: 02 Series: C
---------------------------------	---

CP3339-65E

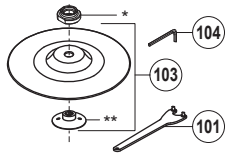

Complete kit		6153961340
101	Pin spanner 35m	6158020100
103	Pad	6159901410
104	Hexagon wrench 8mm	6158020610
*	Rear flange	6155031070
**	Nut	608.29

CP3339-65E

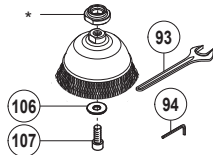

Complete kit		6153961330
93	Spanner flat	6158010770
94	Hexagon wrench 6mm	6158020560
106	Washer	6156420700
107	Screw	6156160020
*	Rear flange	6155031070

CP3339-65E

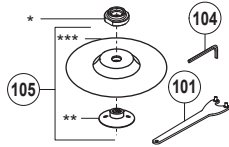

Complete kit		6153961310
101	Pin spanner 35mm	6158020100
104	Hexagon wrench 8mm	6158020610
105	Pad	6159901330
*	Rear flange	6155031070
**	Nut	608.47
***	Pad	6159901340

CP3339-SALAVET / CP3349-SALAVET

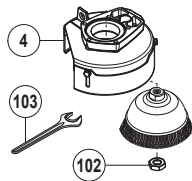

Guard complet 6 US		6155041780
102	Nut	615 6080490
103	Spanner flat	615 8010770

6159945170
Issue no: 02
Series: C

CP3339/CP3349 Vertical Grinders

SPARE PARTS SERVICE CHART



The service chart is published as a guide to expectant life of component parts
The replacement levels are based on average tool usage over one year period.
You can find Part No with Item No.

Part No / Item	Description	Qty	WEAR				Subject to external damage
			High (100%)	Medium (70%)	Low (30%)	Non (10%)	
See page 4							
6156452200	Spacer complete	1					
6155041810	Complete guard 6" CE	1					X
6155041820	Complete guard 7" CE	1					X
6155041830	Complete guard 9" CE	1					X
6155041780	Complete guard 6" US	1					X
6155041790	Complete guard 7" US	1					X
6155041800	Complete guard 9" US	1					X
See page 4							
6155031160	Rear flange	1			X		
6155031030	Rear flange	1			X		
6155421040	Nut	1		X			
6156140340	Screw	1					X
6156101050	Screw	1				X	
6156101070	Screw	1				X	
6158010770	Spanner flat	1				X	
6158020100	Pin spanner	1				X	
6158020560	Hex. Wrench 6mm	1				X	
6158020610	Hex. Wrench 8mm	1				X	
6155952020	Lever	1				X	
608.49	Nut	1				X	
6156452180	Spring washer	1				X	
6155031460	Rear flange balancer	1			X		
See page 7							
20	Handle kit	1					X
21	Lever	1					X
22	Latch lever	1					X
23	Latch lever spring	1				X	
24	Grooved pin	1			X		
25	Grooved pin	1				X	
26	Bushing inlet	1					X
27	O-Ring	1	X				
28	Screen	1					X
29	Ball spring	1			X		
30	Ball	1	X		X		
31	Ball seat	1			X		
32	Needle	1				X	
33	Lever spring	1			X		
34	O-Ring	1	X				
35	Screw	4				X	

Part No / Item	Description	Qty	WEAR				Subject to external damage
			High (100%)	Medium (70%)	Low (30%)	Non (10%)	
See page 9							
40	Housing	1					X
42	Felt	1				X	
43	Oil tank down	1				X	
44	O-Ring	1	X				
45	Washer	1				X	
46	Oil plug	1				X	
47	Tool label	1					X
48	Grooved nail	4				X	
49	Exhaust grid	1				X	
50	Screw	4				X	
51	O-Ring	1	X				
52	Oil tank up complete	1			X		
53	Side handle complete	1					X
See page 11							
60	Cylinder	1			X		
61	Front plate	1		X			
62	End plate	1		X			
63	Rotor	1			X		
64	Vane	3	X				
65	Governor	1			X		
66	Spacer	1				X	
67	Nut	1				X	
68	Flange	1			X		
69	Plug	1		X			
70	Spring	1		X			
71	Governor housing	1			X		
72	O-Ring	1	X				
73	O-Ring	1	X				
74	Bearing	1	X				
75	Bearing	1	X				
76	Rear flange	1			X		
77	O-Ring	1	X				