

Date Code

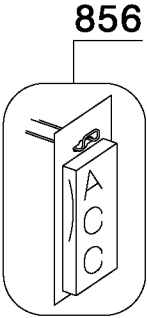
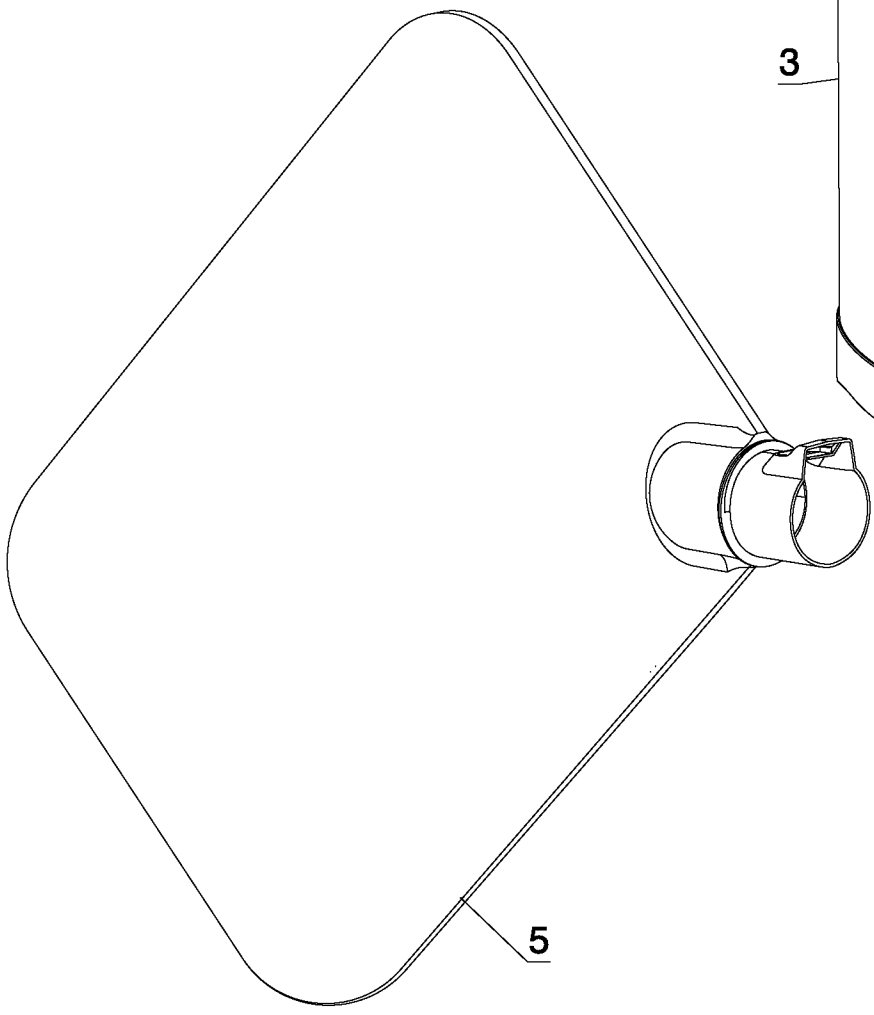
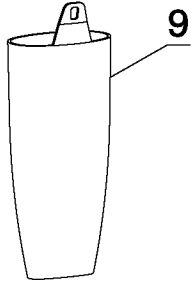
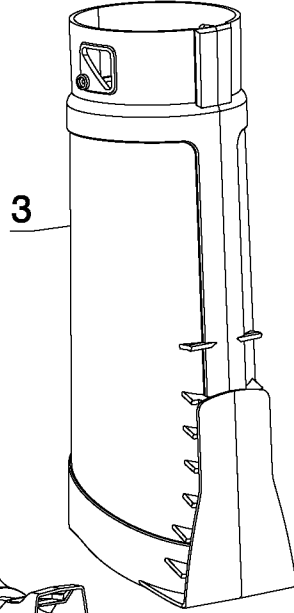
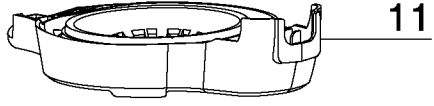
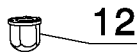
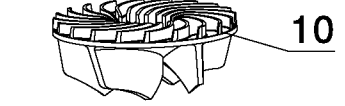
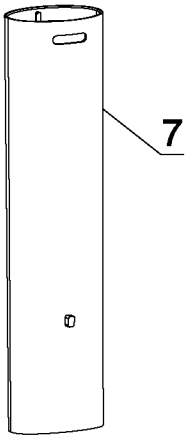
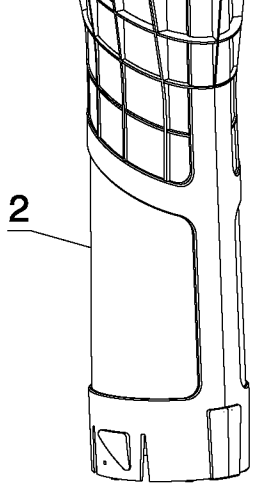
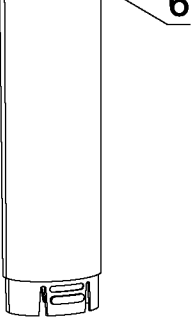
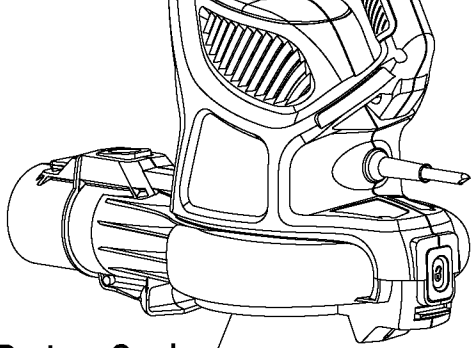

Parts List for BV3600 Type 2

Item Number	Part Number	Description	Qty Required
1	90575700	BLOWER UNIT	1
2	90526071	VACUUM ADAPTER	1
3	90516719	LOWER TUBE	1
5	90560020	SHOULDER BAG	1
6	90519931	BLOW TUBE ASSM.	1
7	90519932	BLOW TUBE ASSM.	1
9	90520039	NOZZLE	1
10	90519818	FAN	1
11	90519489	GRILL	1
12	90556361	LOCK NUT	1
856	90528426	TRASH CAN ADAPTER	1