

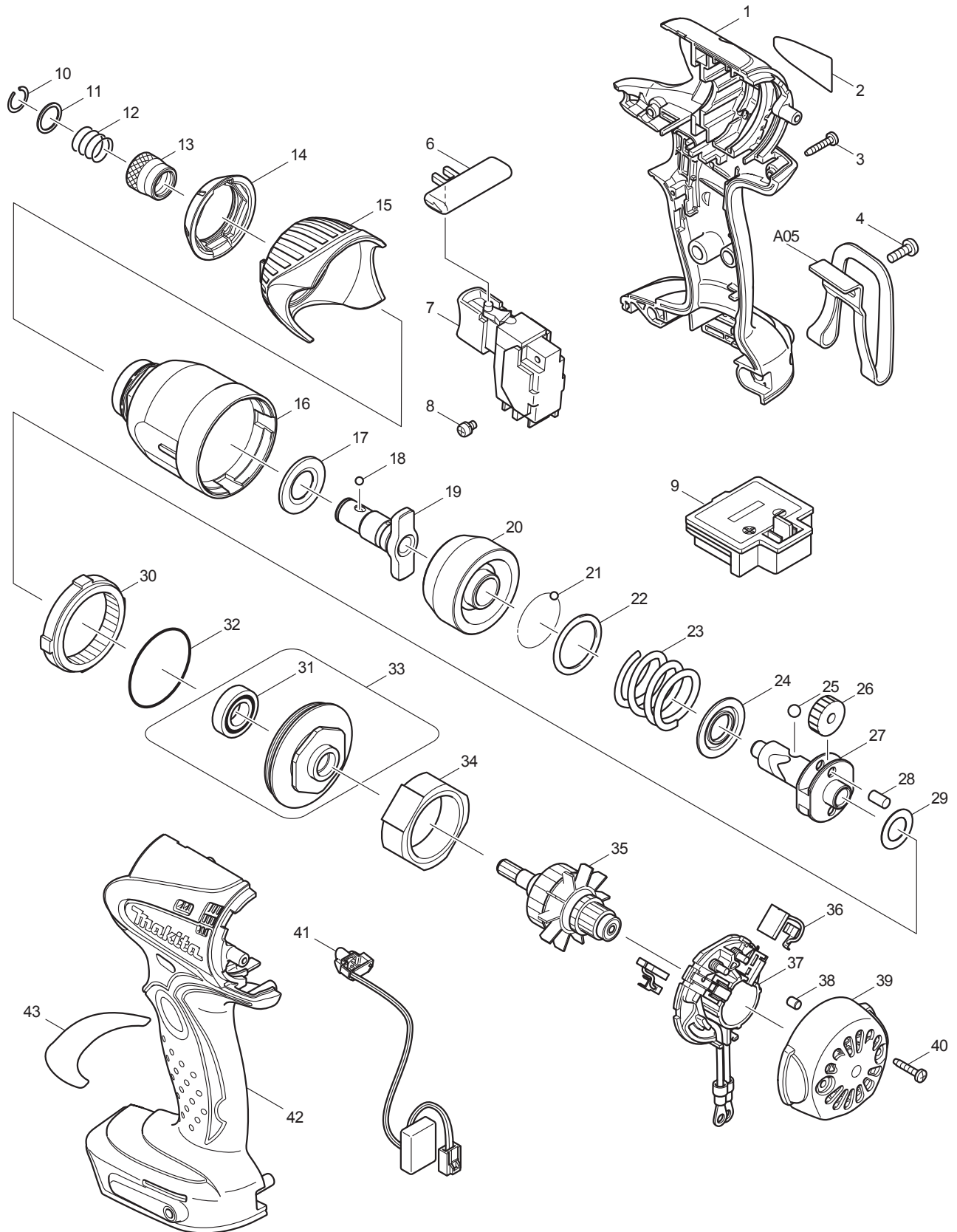

09 - 2011  
BTD141, BTD141Z, BTD141H2  
18V IMPACT DRIVER KIT



Item N	Type	Sub	Part No	Description	Qty	Unit
1	1		188127-7	HOUSING SET(BLUE) (BTD141, BTD141H2)	1	SET
	1		188239-6	HOUSING SET(WHITE) (BTD141HW)	1	SET
	2		188691-8	HOUSING SET(BLUE)	1	SET
	3		187075-7	HOUSING SET(BLUE)	1	SET
3	1		266130-9	TAPPING SCREW BIND PT 3X16	8	PC.
	2		266429-2	TAPPING SCREW 3X16	8	PC.
4			251314-2	(+) SCREW M4X12 (F/ HOOK)	1	PC.
6			419041-9	F/R CHANGE LEVER	1	PC.
7			650564-0	SWITCH TG553FSB-1	1	PC.
8			652045-0	(+) P.H. SCREW M3.5X5	2	PC.
9	1		643812-4	TERMINAL, BLACK	1	PC.
	2		643844-1	TERMINAL, YELLOW	1	PC.
10			231951-8	RING SPRING 11	1	PC.
11			267085-1	FLAT WASHER 12	1	PC.
12			233005-7	COMPRESSION SPRING 13	1	PC.
13			324871-4	SLEEVE	1	PC.
14	1		424015-7	* BUMPER	1	PC.
	2		424369-2	* BUMPER	1	PC.
15	1		450585-0	* HAMMER CASE COVER	1	PC.
	2		452409-6	* HAMMER CASE COVER	1	PC.
16			154590-6	HAMMER CASE COM	1	PC.
17			261108-7	NYLON WASHER 14	1	PC.
18	1		216001-0	STEEL BALL 3.5	2	PC.
	2		216040-0	STEEL BALL 3.5	2	PC.
19			324870-6	ANVIL M	1	PC.
20			324583-9	HAMMER	1	PC.
21	1		216001-0	STEEL BALL 3.5	2	PC.
	2		216040-0	STEEL BALL 3.5	2	PC.
22			267175-0	FLAT WASHER 24	1	PC.
23			233430-2	COMPRESSION SPRING 24	1	PC.
24			267766-7	CUP WASHER 14	1	PC.
25	1		216011-7	STEEL BALL 5.6	2	PC.
	2		216041-8	STEEL BALL 5.6	2	PC.
26			226336-1	SPUR GEAR 22	2	PC.
27			324552-0	SPINDLE	1	PC.
28			256253-1	PIN 5	2	PC.
29			267212-0	FLAT WASHER 12	1	PC.
30			227150-8	INTERNAL GEAR 51	1	PC.
31			211140-1	BALL BEARING 6901LLB	1	PC.
32			213507-9	O RING 40	1	PC.
33			154769-9	BEARING BOX COM (INCLUDED ITEM 31)	1	PC.
34			638396-5	YORK UNIT	1	PC.
35	1		619172-6	ARMATURE - N/L/A	1	PC.
	2		619247-1	ARMATURE	1	PC.
	3		619372-8	ARMATURE	1	PC.
36	1		194427-5	* CARBON BRUSH CB-440, 2PCS/SET, W/O ORIGIN - N/L/A	1	SET
	2		195021-6	* CARBON BRUSH CB-440 2PC/SET, W/ ORIGIN	1	SET
37			638387-6	BRUSH HOLDER COM	1	PC.
		INC.	231696-8	TORSION SPRING R	2	PC.
		INC.	231697-6	TORSION SPRING L	2	PC.
38			263032-0	RUBBER PIN 4	2	PC.
39			418981-8	REAR COVER (BTD141, BTD141H2)	1	PC.
39			418982-6	REAR COVER (BTD141HW)	1	PC.
40	1		266130-9	TAPPING SCREW BIND PT 3X16	2	PC.
	2		266429-2	TAPPING SCREW 3X16	2	PC.
41			631792-6	LIGHT CIRCUIT	1	PC.
43			810292-1	CAUTION LABEL	1	PC.

**ACCESSPROES****- See catalogue or visit [www.makita.ca](http://www.makita.ca) for more optional accessories -**

A01	1	DC18RA	CHARGER DC18RA F/BL1830 (BTD141, BTD141Z)	1	PC.
	2	DC18RC	CHARGER DC18RC (BTD141, BTD141Z)	1	PC.
		DC18SD	CHARGER DC18SD (BTD141H2)	1	PC.
		DC18RAKIT	CHARGER DC18RA + BATTERY BL1830	1	SET
		DC18SE	AUTOMOTIVE CHARGER DC18SE	1	PC.
		DC24SC	CHARGER F/7.2-24V, 1.3-3.3AH	1	PC.
A02		824812-5	PLASTIC CARRYING CASE (BLOW MOLD)	1	PC.
	INC.	163455-1	METAL LATCH	2	PC.
		824753-5	PLASTIC CARRYING CASE (OPTIONAL)	1	PC.
	INC.	324207-7	SHAFT	1	PC.
	INC.	413098-2	PLATE	4	PC.
	INC.	417724-5	LATCH	2	PC.
	INC.	419215-2A	PLASTIC CASE LID, TAB TYPE	1	PC.
	INC.	419216-0	HANDLE	1	PC.
A03		450128-8	BATTERY COVER	1	PC.
A04		194205-3	18V LI-ION BATTERY BL1830 (BTD141)	1	PC.
		194230-4	18V LI-ION BATTERY BL1830 (2/PK)	2	SET
		194309-1	18V LI-ION BATTERY BL1815 (BTD141H, BTD141HW)	1	PC.
		194428-3	18V LI-ION BATTERY BL1815 (2/PK)	2	SET
A05	1	324705-1	HOOK F/ BL1430, BL1830	1	PC.
	2	346449-3	* HOOK F/14.4V. 18V	1	PC.
	1	346034-2	HOOK F/BL1415, BL1815 (BTD141H2 SE until March 2013)	1	PC.
	2	346449-3	* HOOK F/14.4V. 18V (BTD141H2 SE From April 2013)	1	PC.

**SERVICE CHANGES**

**1. Changes on Hammer Case Cover and Bumper**

Item No.	Description	Type 1	Type 2
14	Bumper	424015-7	424369-2
15	Hammer Case Cover	450585-0	452409-6

Above parts are completely interchangeable as a set.

Type1: Bumper is hooked with the grooves of Hammer case.

Type2: Bumper is hooked with the protrusions of Hammer case cover as illustrated below.

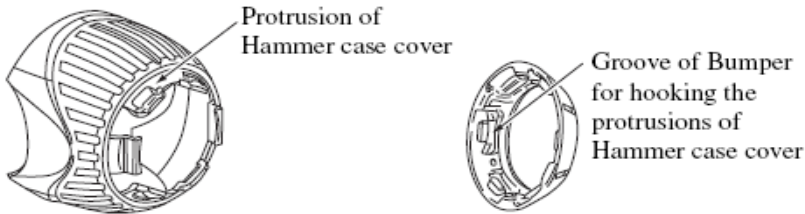

**2. Changes How to Assemble Carbon Brushes**

Item No.	Description	Type 1	Type 2
36	Carbon Brush	194427-5 (W/O ORIGIN)	195021-6 (W/ ORIGIN)

Do not protrude the pigtails of Carbon brushes from the specific spaces.  
Refer to the following illustration.

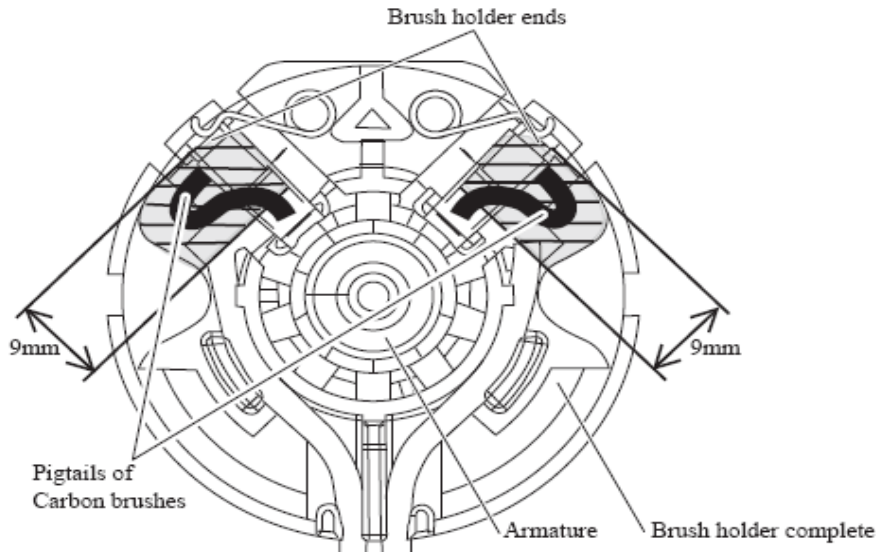

### 3. Changes on Hook

Item No.	Description	Type 1	Type 2
A05	HOOK	324705-1	346449-3
A05	HOOK	346034-2	346449-3

Width has been changed wide size to narrow size

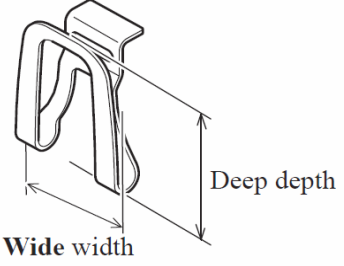
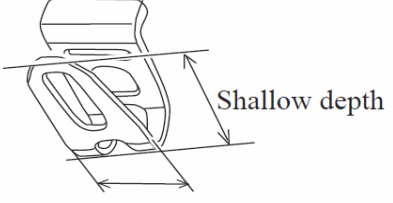
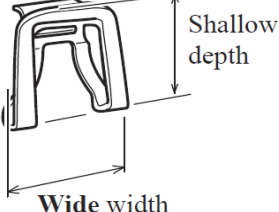
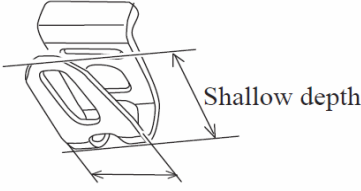
Type 1	Type 2
 <p><b>Wide width</b> (324705-1)</p>	 <p><b>Narrow width</b> (346449-3)</p>
 <p><b>Wide width</b> (346034-2)</p>	 <p><b>Narrow width</b> (346449-3)</p>