

0 603 310 735
 Stand } 09-02
 Issue } 07-11-09

Fig./Abb. 1

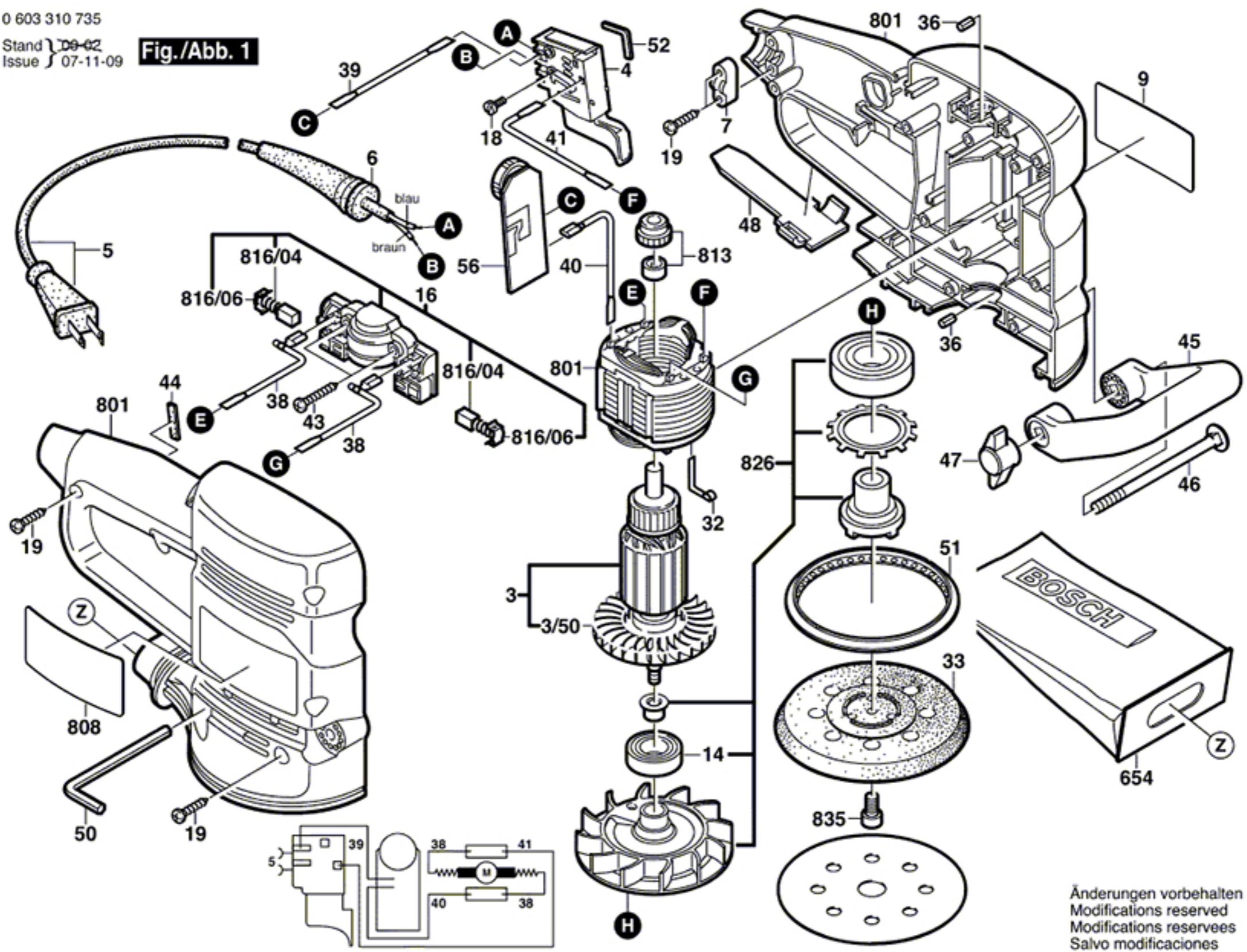

Änderungen vorbehalten
 Modifications reserved
 Modifications reserves
 Salvo modificaciones