

0 601 656 139
Issue } 03-01-21
Stand }

Fig./Abb. 1

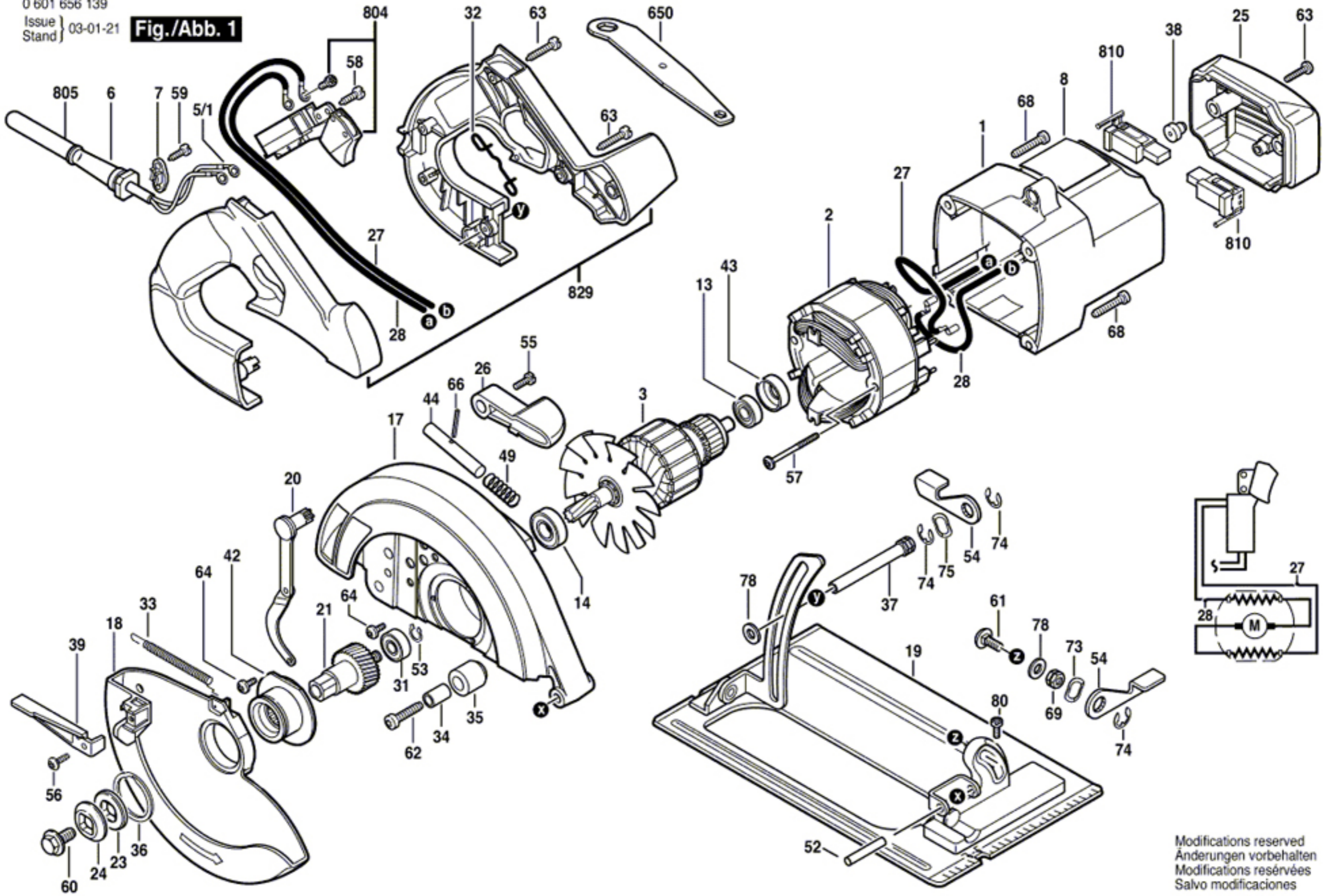

Modifications reserved
Änderungen vorbehalten
Modifications réservées
Salvo modificaciones