

Item	Part No	Description	Qty
1	113.520	Body B15	1
"	113.523	Body B16	1
2	143.523	Piston B16	1
"	143.525	Piston B15	1
3	250.512	Tube, straight front B16M	1
"	250.522	Tube, straight front B15M	1
4	250.513	Anvil B16M	1
"	250.520	Anvil B15M	1
5	250.514	19 Needle holder Ø3mm B16M	1
"	250.521	12 Needle holder Ø3mm B15M	1
6	321.574	Throttle lever	1
7	395.519	Valve body assembly B15 (6-11-12)	1
"	395.520	Valve body assembly B16 (6-11-12)	1
8		Needle chisel point B16M	1
"		Needle chisel point B15M	1
9	566.542	Intermediate tube B15M	1
"	566.544	Intermediate tube B16M	1
10	616.05	Screw	2
11	637.116	Pin lever	1

Item	Part No	Description	Qty
12	399.745	Valve stem set (16-17)	1
13	658.240	O Ring B15	1
"	658.244	O Ring B16	1
15	681.579	Spring - Compression B16M	1
"	681.581	Spring - Compression B15M	1
16	658.239	O Ring	1
17	681.578	Spring	1
		Nameplate	1

	6158727980	Warning label
	6159948780	Safety instructions
	6159943760	Operator's manual

**Spare parts without part number are not sold separately**

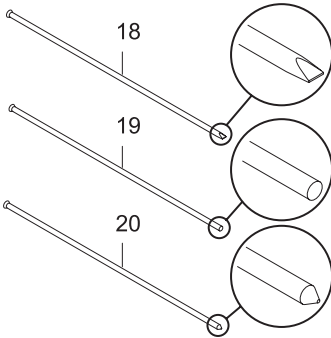

Item	Part No	Description	Qty
	6158020560	Hex. Key 6 mm	1
	6155961050	1/4" air hose nipple for 10 mm (3/8") ID hose	1

**Optional accessories. Needle Sets. For all models**

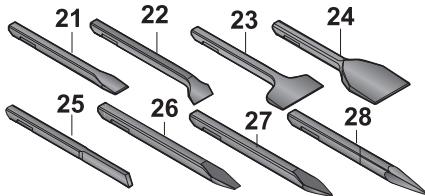
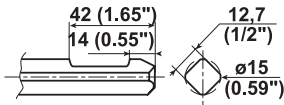
Item	Part No	Description	Qty
18	6153998190	Chisel tip needles, Ø 3 mm (1/8"), length 178 mm (7") (Qty 100)	1
19	6153998160	Flat tip needles, Ø 2 mm (5/64"), length 178 mm (7") (Qty 100)	1
19	6153998170	Flat tip needles, Ø 3 mm (1/8"), length 178 mm (7") (Qty 100)	1
19	6153998180	Flat tip needles, Ø 4 mm (5/32"), length 178 mm (7") (Qty 100)	1
20	6153998210	Pointed tip needles, Ø 3 mm (1/8"), length 178 mm (7") (Qty 100)	1
20	6153998220	Pointed tip needles, Ø 4 mm (5/32"), length 178 mm (7") (Qty 100)	1

**Optional accessories Chisel Scalars : ISO 1/2" Square Shank Chisels**

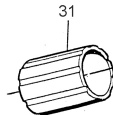
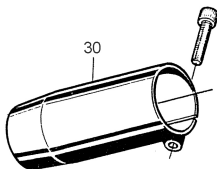
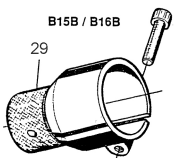
Item	Part No	Description	Qty
21	6158044430	Chisel 1/2", 7" (180 mm) long x 3/4" (19 mm) wide	1
22	6158044440	Angle chisel, 7" (180 mm) long x 1 3/8" (35 mm) wide	1
23	6158044450	Chisel 1/2", 7" (180 mm) long x 3 23/64" (60 mm) wide	1
24	6150039000	Spark-resistant chisel width 1 31/32" (50mm) wide	1
25	6158040620	Chisel, 7" (180 mm) long x 1/4" (6 mm) wide for brick joints	1
26	P073225	Flat chisel, 1 5/8" (15,9 mm) face, length 7 1/2" (191 mm)	1
26	P072213	Flat chisel, 1 3/8" (35 mm) face, length 4" (102 mm)	1
26	P084175	Flat chisel, 1 3/8" (35 mm) face, length 9" (229 mm)	1
26	P084176	Flat chisel, 1 3/8" (35 mm) face, length 12" (305 mm)	1
26	P084177	Flat chisel, 1 3/8" (35 mm) face, length 18" (457 mm)	1
26	P070982	Flat chisel, 44 mm face, length 5 3/8" (213 mm)	1
27	P073224	Cape 1/4" (6,4 mm) face, length 7 1/2" (191 mm)	1
28	P073223	Diamond Pt. 1/4" (6,4 mm) face, length 7 1/2" (191 mm)	1

**Spare parts without part number are not sold separately**

Item	Part No	Description	Qty
29	6152505240	1/2" square tool retainer B15B	1
29	6152505250	1/2" square tool retainer B16B	1
30	6152505230	Round adjustable sleeve B15M	1
30	6152505150	Round adjustable sleeve B16M	1
31	6152505310	Needle holder for 29 needles Ø 2 mm (5/64") B15M	1
31	6152505320	Needle holder for 51 needles Ø 2 mm (5/64") B16M	1

**Conversion to a chisel Hammer**

Take out the intermediate casing (9) together with parts (15 - 4 - 8 and 3).  
In place of intermediate casing, fit the tool retaining sleeve (29) on the cylinder (1).