

EXPLODED VIEW/REPAIR PARTS

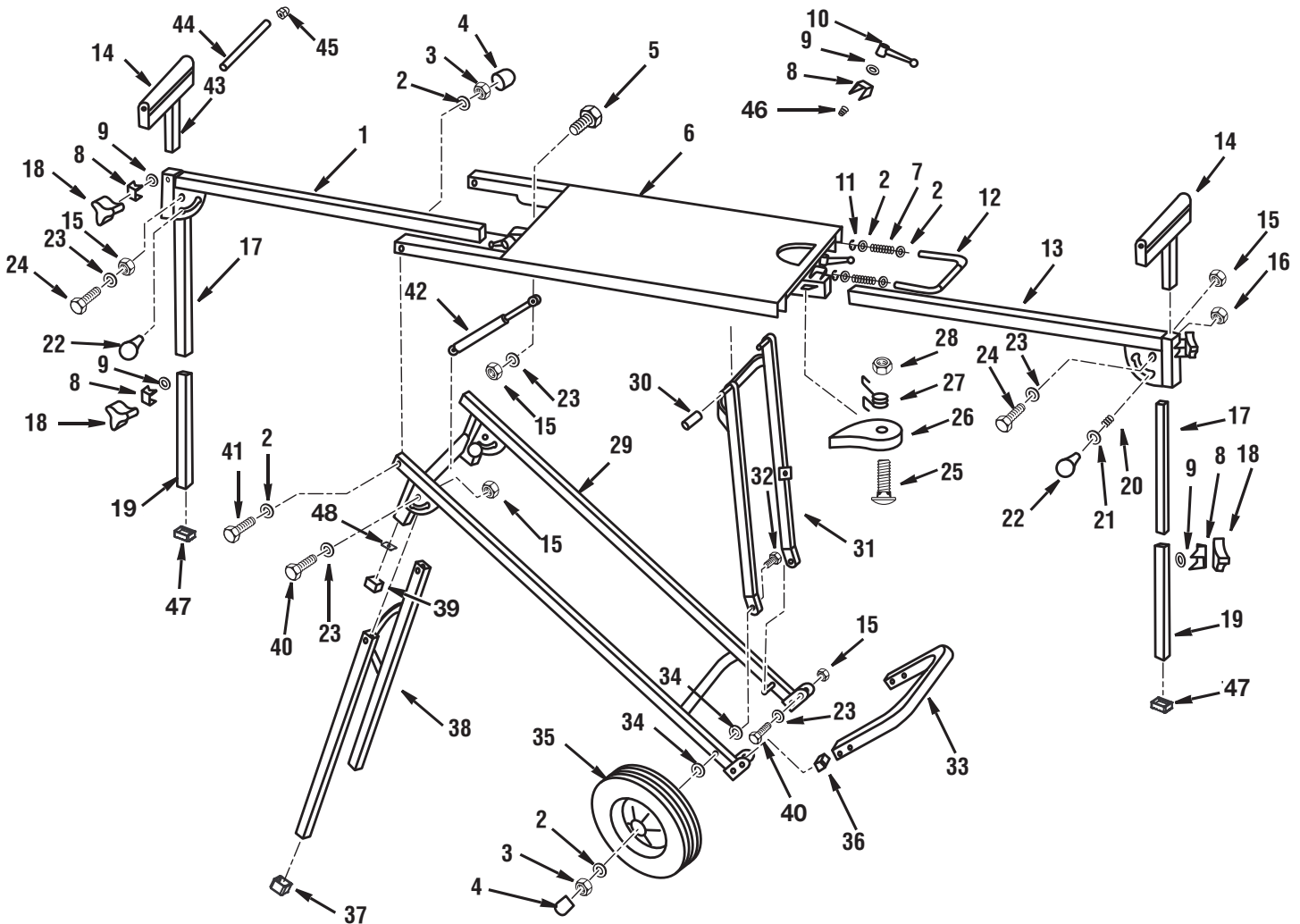

Miter Saw Utility Vehicle Model AC99401 RIDGID parts are at www.ridgidparts.com

Key No.	Part No.	Description	Key No.	Part No.	Description
1	829859	Rear Roller Extension	26	829874	Extension Stop
2	829758-5	Washer (20 x 10.5 x 1.5)	27	829875	Torsion Spring
3	829759-3	Nylock Nut (M10)	28	829759-2	Nylock Nut (M5)
4	829799	Rubber Cap	29	829855	Main Frame
5	829757-6	Hex Head Bolt (M8 x 1.25 x 33)	30	829834	Nylon Roller
6	830256	Table	31	829862	Table Pivot Leg Support
7	829871-1	Compression Spring	32	829835	Shoulder Bolt
8	829741	Clamp	33	829857	Front Foot
9	829758-5	Washer (20 x 10.5 x 1.5)	34	829758-6	Washer (24 x 13 x 2)
10	829742	Handle	35	829868	Wheel
11	829872	E-Ring	36	830270	Plug
12	829908	Latch Pin Assembly	37	829876	Rubber Foot
13	829858	Front Roller Extension	38	829856	Rear Leg Support
14	829865	Roller	39	829877	Rubber Foot
15	829759	Nylock Nut (M8)	40	829757-3	Hex Head Bolt (M8 x 1.25 x 50)
16	829759-1	Nylock Nut (M6)	41	829757-4	Hex Head Bolt (M10 x 1.5 x 60)
17	829860	Leg Roller Support	42	829869	Gas Spring
18	829833	Knob	43	829864	Roller Support
19	829861	Leg Roller Extension	44	829954	Roller Shaft
20	829871	Compression Spring	45	829955	Cap Roller
21	829758-10	Washer (13 x 6.5 x 3)	46	000900108002	Tower Spring
22	829878	Locking Pin	47	829960	Cap - Roller Leg
23	829758-3	Washer (16 x 8.5 x 1.5)	48	000900108003	Plate Insert
24	829757	Hex Head Bolt (M8 x 1.25 x 47)		983000-894	Operator's Manual
25	829836	Hex Head Bolt (M5 x 0.8 x 15)			