

Type:
Part no.:

GRIT GIC
79021200443



Item	Part no.	Designation	Quantity	Price RPR excl. VAT (USD)	AT
0010	39000001090	Motor 0,18KW/1500 RPM	1	on req.	-
0030	39000006331	Cable	1	on req.	-
0050	39000004502	Housing	1	on req.	-
0060	39000004511	Cover	1	on req.	-
0070	39000004527	Cover	1	on req.	-
0080	39000004526	Cover	1	on req.	-
0090	39000004528	Plate	1	on req.	-
0100	39000005415	Adjustable foot	4	on req.	-
0110	39000005117	Wheel	4	on req.	-
0120	39000000715	Nut M12	12	on req.	-
0130	39000004530	Cover	1	on req.	-
0140	39000004561	Handle	1	on req.	-
0150	39000004576	Clamp	2	on req.	-
0160	39000000191	Screw M6X10	2	on req.	-
0170	39000000595	Screw M8X12	8	on req.	-
0180	39000005955	Nut M6	16	on req.	-
0190	39000004559	Clamp	1	on req.	-
0200	39000005672	Screw	4	on req.	-
0210	39000004508	Rod	1	on req.	-
0220	39000000046	Nut M5	2	on req.	-
0230	39000001200	Nut M25	1	on req.	-
0240	39000005937	Cable clamping piece	1	on req.	-
0250	39000000528	Nut M8	4	on req.	-
0260	39000004539	Spring	1	on req.	-
0270	39000001318	Thread spindle	1	on req.	-
0280	39000004570	Spacer	1	on req.	-
0290	39000000427	Screw M6X10	1	on req.	-
0300	39000000475	Crank	1	on req.	-
0310	39000004549	Guide	1	on req.	-
0320	39000000623	Screw M8X20	2	on req.	-
0330	39000000164	Screw M8X10	2	on req.	-
0340	39000000633	Screw M6X30	2	on req.	-
0350	39000004603	Guide	1	on req.	-
0360	39000000630	Screw M6X25	2	on req.	-
0370	39000000090	Disc	8	on req.	-
0380	39000004540	Adjustment unit	1	on req.	-
0390	39000000634	Screw M8X16	2	on req.	-
0400	39000000061	Nut M8	2	on req.	-
0410	39000001532	Handle M8X20	3	on req.	-
0420	39000004541	Stop	1	on req.	-
0430	39000000165	Screw M8X16	1	on req.	-
0440	39000006322	Screw	1	on req.	-
0450	39000004555	Spring	1	on req.	-
0460	39000004543	Sleeve	1	on req.	-
0470	39000004556	Spring	1	on req.	-
0480	39000000163	Disc	2	on req.	-
0490	39000000063	Nut M12	1	on req.	-
0500	39000004538	Holder	1	on req.	-
0510	39000000153	Bolt M8x45	1	on req.	-

Type:
Part no.:

GRIT GIC
79021200443



Item	Part no.	Designation	Quantity	Price RPR excl. VAT (USD)	AT
0520	39000000528	Nut M8	1	on req.	-
0530	39000000050	Screw M6X40	4	on req.	-
0540	39000000432	Screw M10X16	2	on req.	-
0550	39000000062	Nut M10	4	on req.	-
0560	39000006330	Thread bolt	1	on req.	-
0570	39000004567	Handle	2	on req.	-
0580	39000001066	Handle M10X60	1	on req.	-
0590	39000000099	Screw M10X20	1	on req.	-
0600	39000000168	Disc D36/10,5X4	1	on req.	-
0610	39000000089	Cup spring 8,2x0,9 mm	1	on req.	-
0620	39000000165	Screw M8X16	4	on req.	-
0630	39000004547	Clamp	1	on req.	-
0640	39000004548	Clamp	1	on req.	-
0650	39000004546	Clamp	1	on req.	-
0660	39000000619	Screw connection M16	1	on req.	-
0670	39000001061	Bearing D20	1	on req.	-
0680	39000000606	Flange	2	on req.	-
0690	39000000477	Gearbox	1	on req.	-
0700	39000001054	Brake wheel	1	on req.	-
0710	39000000622	Blade	1	on req.	-
0720	39000000621	Hood	1	on req.	-
0730	39000000496	Guide rail, brass	1	on req.	-
0730	39000002575	Sliding piece (1 Stück)	2	on req.	-
0740	39000004531	Adjustment unit	1	on req.	-
0750	39000004554	Drilling template	1	on req.	-
0760	39000006323	N.A.	1	on req.	-
0770	39000004441	Handle	1	on req.	-
0780	39000004568	Plug	1	on req.	-
0790	39000004545	Clamp	1	on req.	-
0800	39000000088	Disc	4	on req.	-
0810	39000006100	Sign	1	on req.	-
0820	39000000614	Feather key	2	on req.	-
0830	39000001083	Sign	1	on req.	-
0840	39000000041	Screw M6X16	4	on req.	-
0900	39000004500	Fitting	1	on req.	-
9000	39410015000	Operating instructions	1	on req.	-

Type:
Part no.:

GRIT GIC
79021200443

7 902 12 - GIC

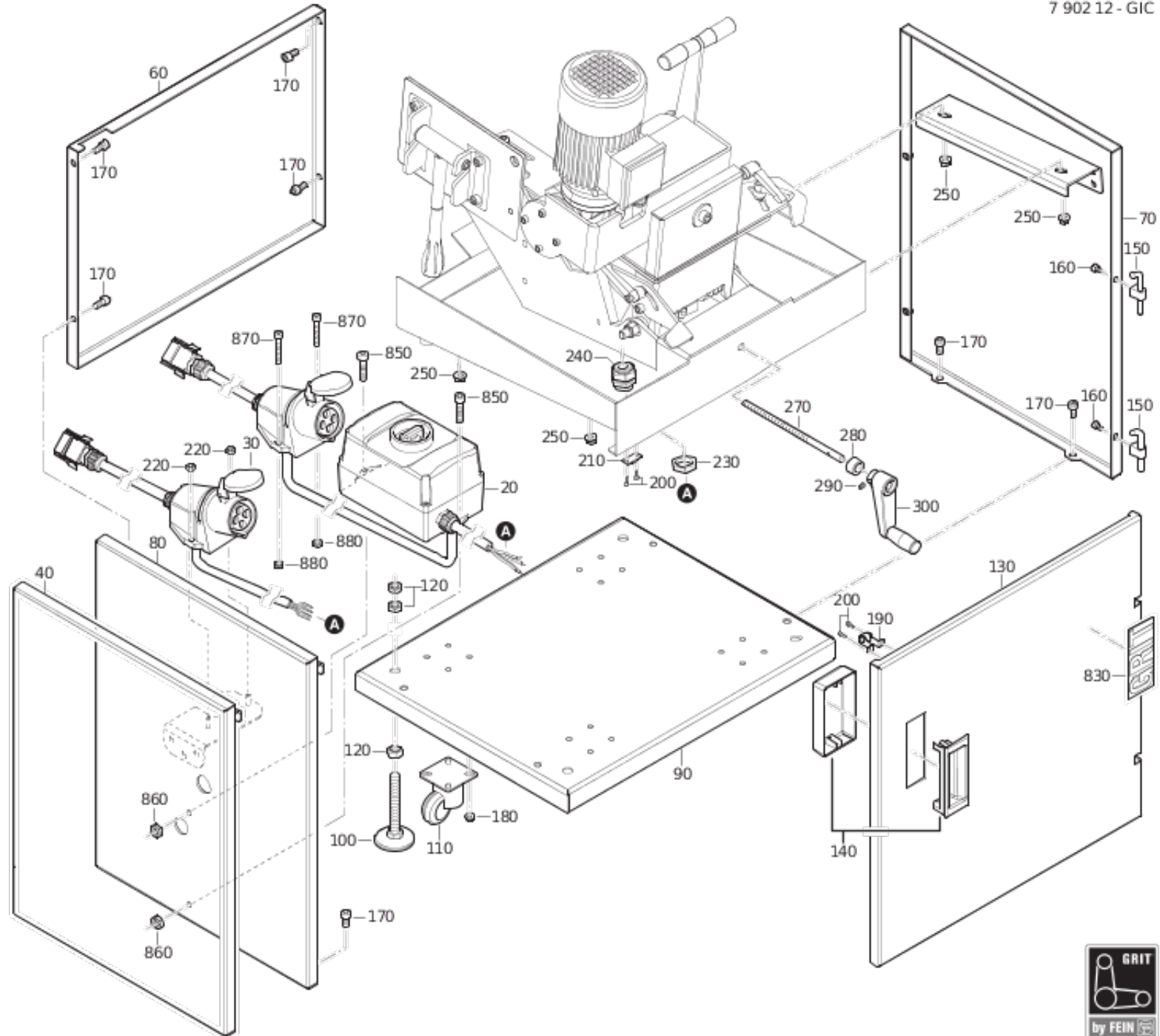

Type:
Part no.:

GRIT GIC
79021200443

7 902 12 - GIC

