

**Bauart:**  
**Best.-Nr.:**

**SCT 5-40 X (60Hz,120V)**  
**72131312360**



Pos.	Best.-Nr.	Benennung	Stk	Preis UVP o. MwSt. (USD)	AT
0010	31901138011	Motor housing	1	a. A.	-
0020	30701234002	Speed setting switch	1	a. A.	-
0021	43013052033	Cylinder head screw	2	a. A.	-
0040	30701249004	Toggle switch	1	a. A.	-
0060	30712089023	Brush holder	2	a. A.	-
0065	30711134005	Carbon brush	2	a. A.	-
0080	43070018009	Screw	2	a. A.	-
0090	51274004117	Stator	1	a. A.	-
0100	43070014000	Screw	2	a. A.	-
0110	31428149008	Air guide ring	1	a. A.	-
0120	32431046000	Cable clamping piece	1	a. A.	-
0130	43070006008	Screw	1	a. A.	-
0160	30719565016	Connecting cable	1	a. A.	-
0170	30719566019	Connecting cable	1	a. A.	-
0180	30719630014	Connecting cable	1	a. A.	-
0190	31201136010	Handle half shell	1	a. A.	-
0200	31201137000	Handle half shell	1	a. A.	-
0205	31201136030	Handle Repair-Set	1	a. A.	-
0210	32805191002	Switch pushbutton	1	a. A.	-
0220	43066009038	Countersunk screw	1	a. A.	-
0240	43046003009	Sheet metal screw 3,9X22	2	a. A.	-
0250	43070007002	Screw	1	a. A.	-
0275	30707345019	Cable with plug	1	a. A.	-
0280	31413233000	Cable grommet	1	a. A.	-
0301	53274004119	Armature Z=5	1	a. A.	-
0310	32612063005	Sealing ring	1	a. A.	-
0340	41701001172	Grooved ball bearing	2	a. A.	-
0355	31506367014	Intermediate bearing	1	a. A.	-
0360	31508251002	Gearbox housing	1	a. A.	-
0370	41719026007	Disc	1	a. A.	-
0380	41715029009	Needle cage	1	a. A.	-
0390	32408395000	Disc	1	a. A.	-
0400	33657161007	Gear-wheel	1	a. A.	-
0410	32624094032	Disc	2	a. A.	-
0420	30901139007	Spiral spring	1	a. A.	-
0440	30104133006	Tool holder	1	a. A.	-
0445	30102101013	Clutch ring Z=13	1	a. A.	-
0460	41708014001	Ball	1	a. A.	-
0470	31603045005	Bush	1	a. A.	-
0480	40612093004	Sealing ring	1	a. A.	-
0490	30503151006	Sleeve	1	a. A.	-
0500	30901362001	Spiral spring	1	a. A.	-
0510	32601274004	Ring	1	a. A.	-
0520	42615147001	Circlip	1	a. A.	-
0705	30505069011	Stop sleeve	1	a. A.	-
0710	41708019004	Ball	2	a. A.	-
0720	40612071009	Sealing ring	1	a. A.	-
0730	32127068000	Sleeve	1	a. A.	-
0960	43072010009	Screw	3	a. A.	-

**Bauart:****SCT 5-40 X (60Hz,120V)****Best.-Nr.:****72131312360**

Pos.	Best.-Nr.	Benennung	Stk	Preis UVP o. MwSt. (USD)	AT
1010	63901011059	Holder	1	a. A.	X
1040	30232046008	Wire clamp	1	a. A.	-
1100	32217382018	Information sign	1	a. A.	-
5000	60510215003	Tool holder ¼" external hexagon	1	a. A.	-
5010	62712109034	Bits ¼ Hex socket	1	a. A.	-
6000	32160003217	Lubricant tube 0,085 kg	1	a. A.	-
9000	34101102060	Operating instructions	1	a. A.	-
9010	34151102000	List of spare parts SCT5-40X	1	a. A.	-
9020	34130054061	Safety instruction	2	a. A.	-

Bauart:  
Best.-Nr.:

SCT 5-40 X (60Hz,120V)  
72131312360

7 213 13 SCT 5-40X  
7 213 06 SCT 5-40M

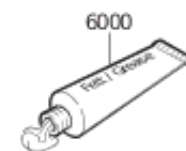
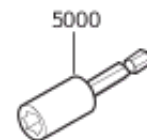
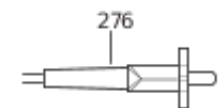
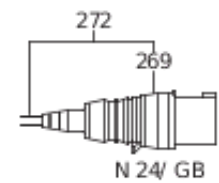
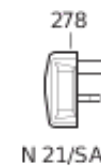
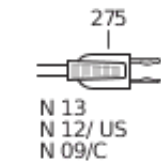
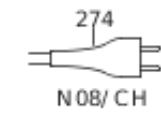
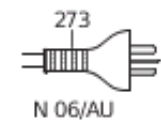
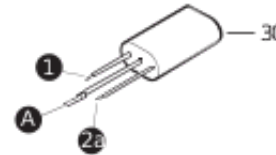
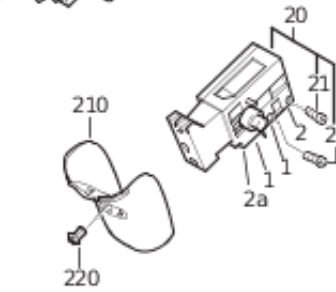
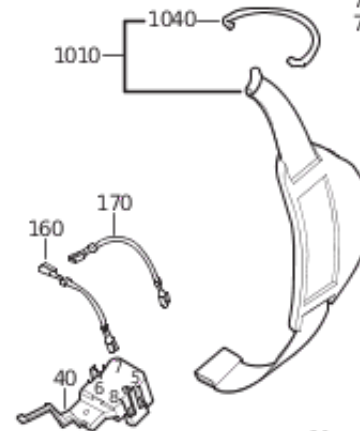
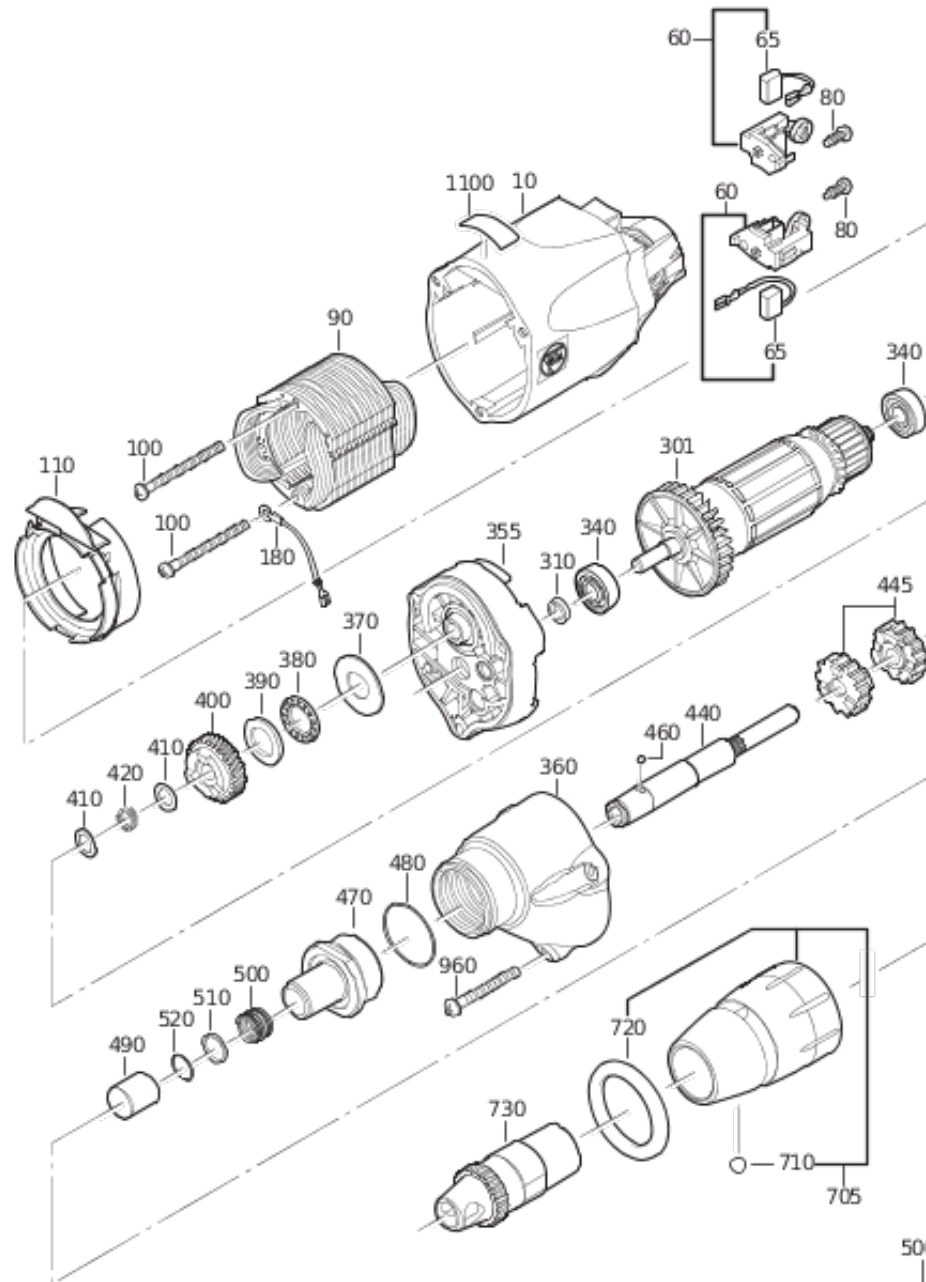

Bauart:  
Best.-Nr.:

SCT 5-40 X (60Hz,120V)  
72131312360

7 213 13 SCT 5-40X  
7 213 06 SCT 5-40M

→ 06.2010

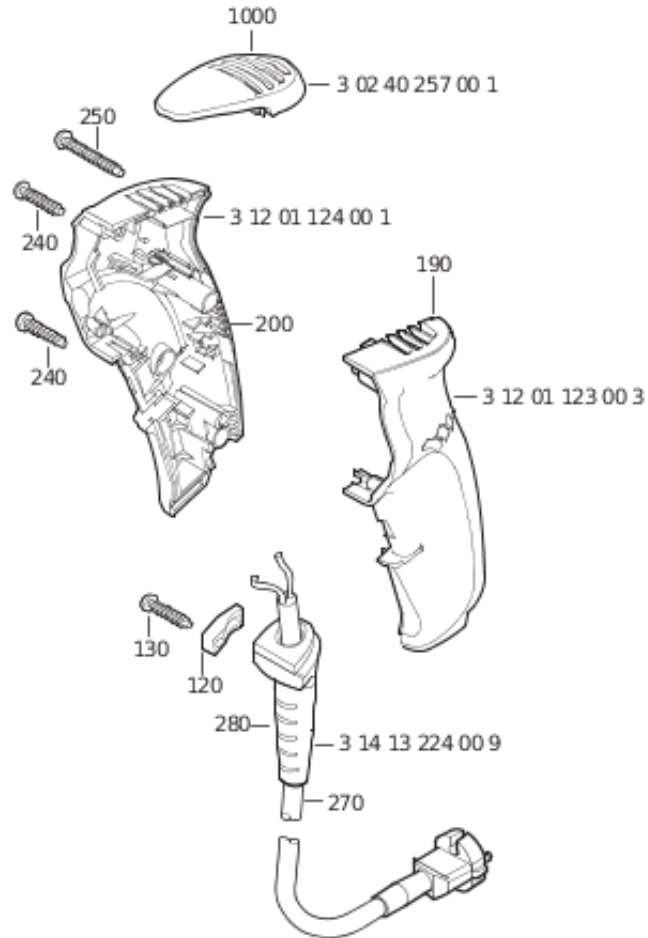

06.2010 →

