

ROTARY LAWN MOWER - - MODEL NUMBER 5521CM (9613300301) PRODUCT NUMBER 961 33 00-03

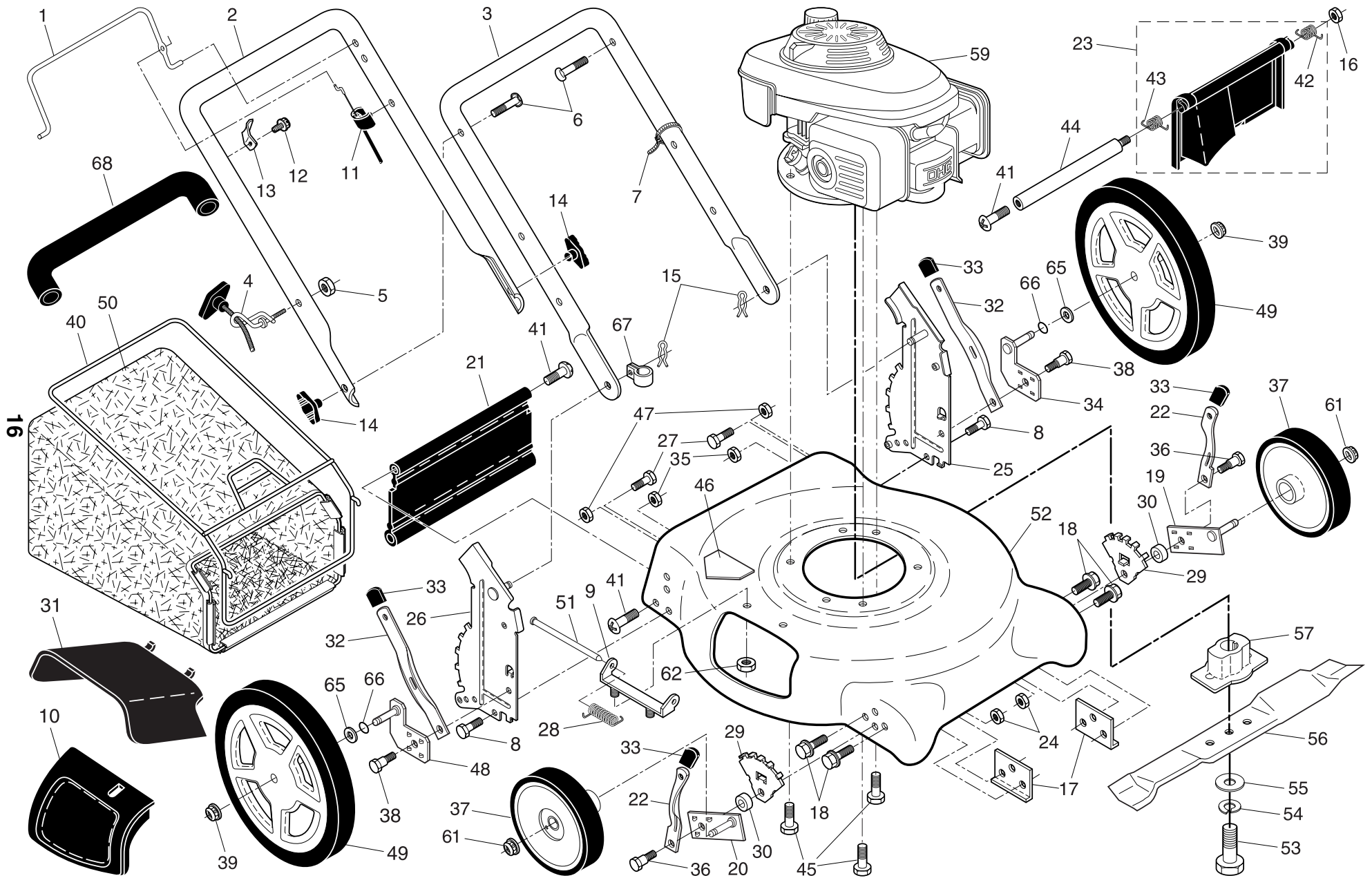

ROTARY LAWN MOWER - - MODEL NUMBER **5521CM** (96133000301) PRODUCT NUMBER 961 33 00-03

KEY NO.	PART NO.	DESCRIPTION	KEY NO.	PART NO.	DESCRIPTION
1	532 40 29-49	Control Bar	35	532 16 67-85	Locknut, Hex 5/16-18
2	532 19 78-08	Upper Handle (Includes Foam Grip)	36	532 16 08-28	Shoulder Bolt 5/16-18
3	532 17 41-10	Lower Handle	37	532 40 05-42	Wheel & Tire Assembly, Front 8 x 1-3/4
4	532 19 47-88	Rope Guide	38	532 16 43-62	Shoulder Bolt
5	532 13 20-04	Locknut, Hex 1/4-20	39	532 14 52-12	Nut, Hex, Flangelock
6	532 19 15-74	Handle Bolt	40	532 19 46-42	Frame, Grassbag
7	532 06 64-26	Wire Tie	41	532 08 86-52	Hinge Screw
8	874 78 05-12	Hex Bolt 5/16-18 x 3/4	42	532 16 57-66	Spring, Rear Door, LH
9	532 15 41-32	Hinge Bracket Assembly	43	532 16 57-67	Spring, Rear Door, RH
10	532 18 55-89	Mulcher Door	44	532 18 58-19	Rod, Rear Door
11	532 17 65-56	Engine Zone Control Cable	45	532 15 04-06	Hex Head Thread Rolling Screw 3/8-16 x 1
12	532 75 06-34	Hex Washer Head Screw #10-24 x 1/2	46	532 10 73-39	Danger Decal
13	532 12 52-03	Up-Stop Bracket	47	532 75 11-53	Nut, Hex
14	532 18 55-88	Handle Knob	48	532 18 36-62	Axle Arm Assembly, Rear, RH
15	532 05 17-93	Hairpin Cotter	49	532 40 29-48	Wheel & Tire Assembly, Rear 12 x 1-3/4
16	532 19 17-30	Nut, Hex, Flangelock 1/4-20	50	532 19 47-15	Grassbag
17	532 17 41-12	Support Bracket	51	532 14 72-86	Hinge Rod
18	817 60 04-06	Screw	52	532 16 36-62	Kit, Lawn Mower Housing Assembly (Includes Key Numbers 17, 18 and 46)
19	532 18 92-77	Axle Arm Assembly, Front, LH	53	532 85 10-84	Hex Head Screw 3/8-24 x 1-3/8 Grade 8
20	532 18 92-78	Axle Arm Assembly, Front, RH	54	532 85 02-63	Helical Lockwasher
21	532 18 90-08	Rear Skirt	55	532 85 10-74	Hardened Washer
22	532 16 85-99	Selector Spring, Front	56	532 18 90-28	21" Blade
23	532 18 66-12	Kit, Rear Door (Includes Springs)	57	532 19 37-07	Blade Adapter
24	873 93 05-00	Locknut, Hex 5/16-18	59	- - -	Engine, Honda, Model Number GCV160 (Order parts from engine manufacturer)
25	532 40 29-45	Handle Bracket Assembly, LH	61	532 08 39-23	Nut, Hex, Flangelock
26	532 40 29-46	Handle Bracket Assembly, RH	62	873 80 04-00	Nut, Hex, Nylock 1/4-20
27	817 60 04-06	Screw 1/4-20 x 3/8	65	532 08 83-48	Washer, Flat
28	532 15 21-24	Spring, Torsion	66	532 19 74-80	O-Ring
29	532 16 57-04	Wheel Adjusting Bracket, Front	67	532 19 79-91	Clip, Cable
30	532 18 39-01	Spacer	68	532 16 42-65	Grip, Foam
31	532 18 55-95	Discharge Deflector	- -	532 16 23-00	Warning Decal (not shown)
32	532 40 29-47	Selector Spring, Rear	- -	532 40 33-90	Owner's Manual, English / French
33	532 18 55-74	Selector Knob			
34	532 18 36-61	Axle Arm Assembly, Rear, LH			

NOTE: All component dimensions given in U.S. inches. 1 inch = 25.4 mm

IMPORTANT: Use only Original Equipment Manufacturer (O.E.M.) replacement parts. Failure to do so could be hazardous, damage your lawn mower and void your warranty.