



4-Bolt Chipping Hammer

#550620, JCT-3620

#550621, JCT-3621

#550622, JCT-3622

#550623, JCT-3623



Operation & Parts Manual

M-550620

Edition 4

11/2018



Stock No.:
Serial No.:
Purchased from:
Date purchased:

JET
427 New Sanford Road
LaVergne, TN 37086
Ph.: 800-274-6848
www.jettools.com

Copyright © 2017 JET

#550621, JCT-3621 3-in. stroke Chipping Hammer, hex shank

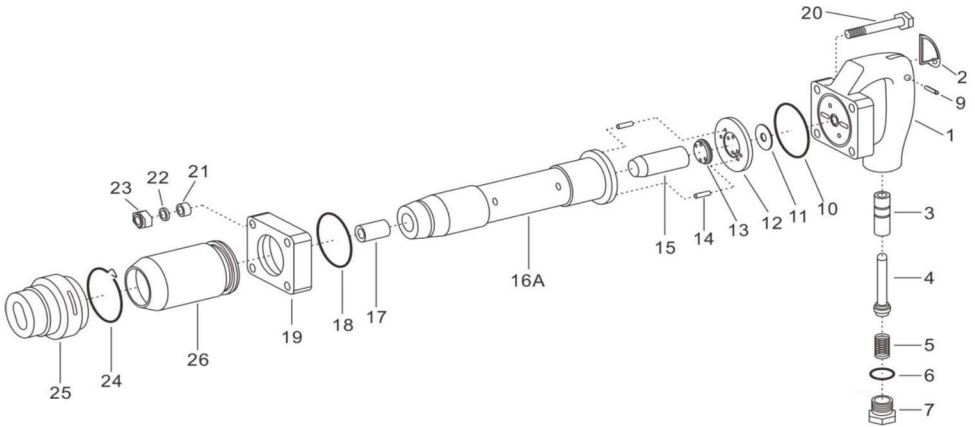

Index	Part No.	Description	Qty
1	JCT3620-01	Handle	1
	JCT3620-01A	Handle Assembly (#1~9)	1
2	JCT3620-02-A	Trigger	1
3	JCT3620-03	Throttle valve stem bushing	1
4	JCT3620-04	Throttle valve 4in.	1
5	JCT3620-05	Throttle valve spring	1
6	JCT3620-06	O-ring, 22x3.5 mm	1
7	JCT3620-07	Air inlet 3/8NPT	1
9	JHM610-93	Roll Pin 6x26 mm	1
10	JCT3620-10	O-ring 56x3 mm	1
11	JCT3620-11	Valve	1
12	JCT3620-12	Valve seat	1
13	JCT3620-13	Valve seat bumper	1

Index	Part No.	Description	Qty
14	JCT3620-14	Dowel pin 6x24mm	2
15	JCT3621-15	Piston 2 in.	1
16A	JCT3621-16	Hex cylinder 2 in.	1
17	JCT3621-17	Shank bushing 0.580 hex	1
18	JCT3620-18	Damping ring	1
19	JCT3620-19	Flange	1
20	JCT3620-20	Handle bolt	4
21	JCT3620-21	Rubber spacer	4
22	JCT3620-22	Steel spacer	4
23	JCT3620-23	Nylon lock nut, black	4
24	JCT3620-24	Retainer coil spring	1
25	JCT3620-25	Retainer	1
26	JCT3620-26	Exhaust deflector 2in.	1

JCT3620-RPK, Repair Kit, includes #3,4,5,6

JCT3620-RBK, Rebuild Kit, includes #2,5,6,9,14(2),18,24