



SERVICE PARTS LIST

BULLETIN NO.
54-04-0341

SPECIFY CATALOG NO. AND SERIAL NO. WHEN ORDERING PARTS			REVISED BULLETIN	DATE
MULTI-BAY CHARGER			54-04-0340	July 2005
			WIRING INSTRUCTION See Reverse Side	
CATALOG NO.	48-59-0260	SERIAL NUMBER	A38B	

NOTE: Cord Holders #19 and #20 may need to be warmed before installing.

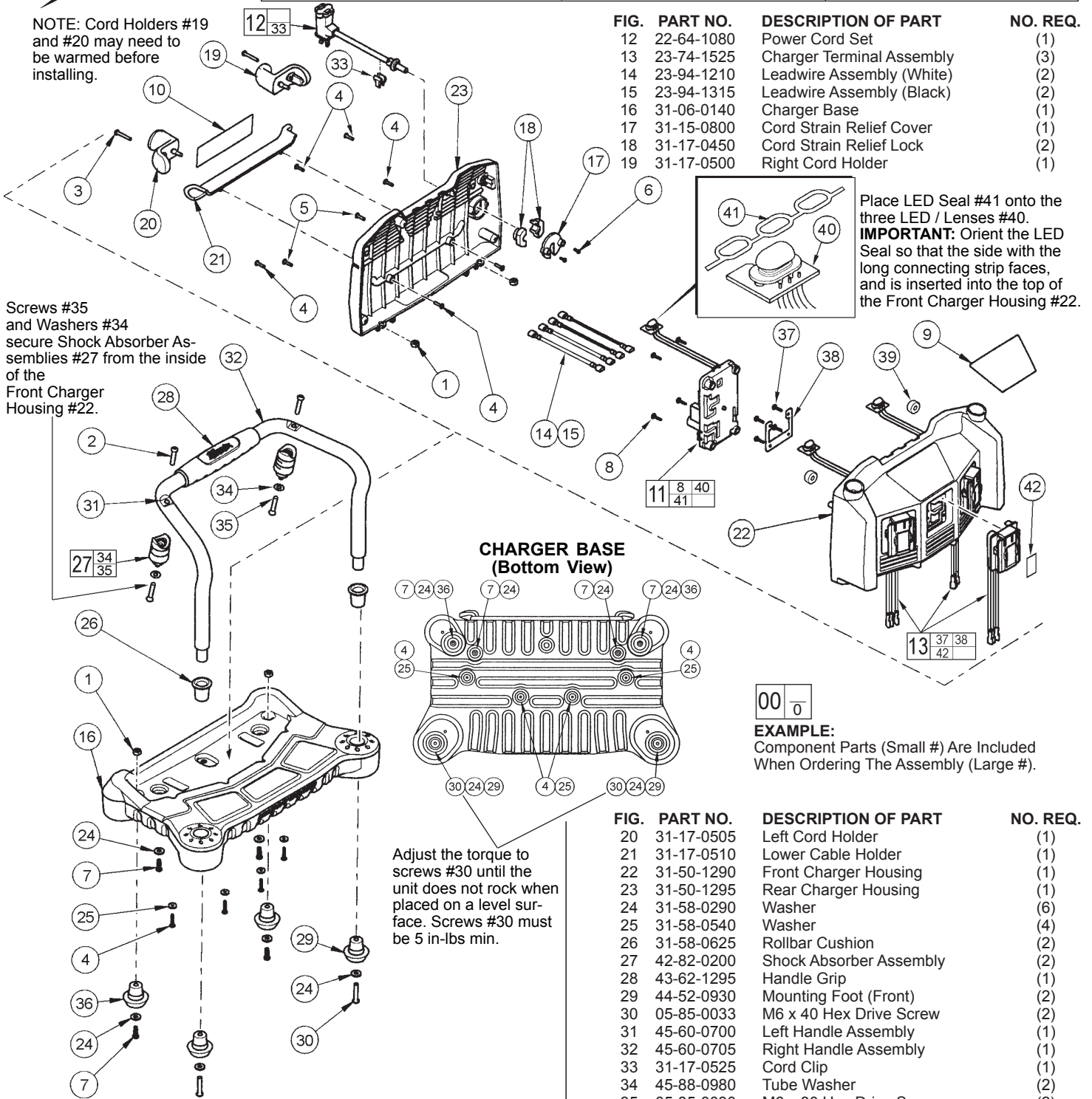

Screws #35 and Washers #34 secure Shock Absorber Assemblies #27 from the inside of the Front Charger Housing #22.

Place LED Seal #41 onto the three LED / Lenses #40.
IMPORTANT: Orient the LED Seal so that the side with the long connecting strip faces, and is inserted into the top of the Front Charger Housing #22.

Adjust the torque to screws #30 until the unit does not rock when placed on a level surface. Screws #30 must be 5 in-lbs min.

EXAMPLE:
Component Parts (Small #) Are Included When Ordering The Assembly (Large #).

FIG.	PART NO.	DESCRIPTION OF PART	NO. REQ.
1	05-55-0200	M6 Nut	(4)
2	05-85-0030	M6 x 30 Hex Drive Screw	(2)
3	05-88-0685	3.5 x 30 Washer Hd. Hex Drive Scr.	(2)
4	05-88-0730	3.5 x 17 Washer Hd. Hex Drive Scr.	(10)
5	05-88-0760	3.0 x 15 Washer Hd. Hex Drive Scr.	(2)
6	05-88-0925	3 x 12 Hex Drive Screw	(2)
7	05-88-1000	M6 x 19 Hex Drive Screw	(4)
8	05-88-0760	3.0 x 15 Washer Hd. Hex Drive Scr.	(12)
9	10-20-1495	Logo Label	(1)
10	12-20-1500	Service Nameplate	(1)
11	22-09-0790	Charger Board Assembly (Incl. #40)	(3)

FIG.	PART NO.	DESCRIPTION OF PART	NO. REQ.
12	22-64-1080	Power Cord Set	(1)
13	23-74-1525	Charger Terminal Assembly	(3)
14	23-94-1210	Leadwire Assembly (White)	(2)
15	23-94-1315	Leadwire Assembly (Black)	(2)
16	31-06-0140	Charger Base	(1)
17	31-15-0800	Cord Strain Relief Cover	(1)
18	31-17-0450	Cord Strain Relief Lock	(2)
19	31-17-0500	Right Cord Holder	(1)
20	31-17-0505	Left Cord Holder	(1)
21	31-17-0510	Lower Cable Holder	(1)
22	31-50-1290	Front Charger Housing	(1)
23	31-50-1295	Rear Charger Housing	(1)
24	31-58-0290	Washer	(6)
25	31-58-0540	Washer	(4)
26	31-58-0625	Rollbar Cushion	(2)
27	42-82-0200	Shock Absorber Assembly	(2)
28	43-62-1295	Handle Grip	(1)
29	44-52-0930	Mounting Foot (Front)	(2)
30	05-85-0033	M6 x 40 Hex Drive Screw	(2)
31	45-60-0700	Left Handle Assembly	(1)
32	45-60-0705	Right Handle Assembly	(1)
33	31-17-0525	Cord Clip	(1)
34	45-88-0980	Tube Washer	(2)
35	05-85-0030	M6 x 30 Hex Drive Screw	(2)
36	44-52-0940	Mounting Foot (Back)	(2)
37	05-88-0760	3.0 x 15 Washer Hd. Hex Drive Scr.	(12)
38	-----	Mounting Plate	(3)
39	31-15-0825	Cover, Cap	(2)
40	23-28-0135	LED / Lens (Component of #11)	(3)
41	43-44-1150	LED Seal	(1)
42	10-20-0890	Terminal Warning Label	(3)

MILWAUKEE ELECTRIC TOOL CORPORATION
13135 W. LISBON RD., BROOKFIELD, WI 53005
Drwg. 2

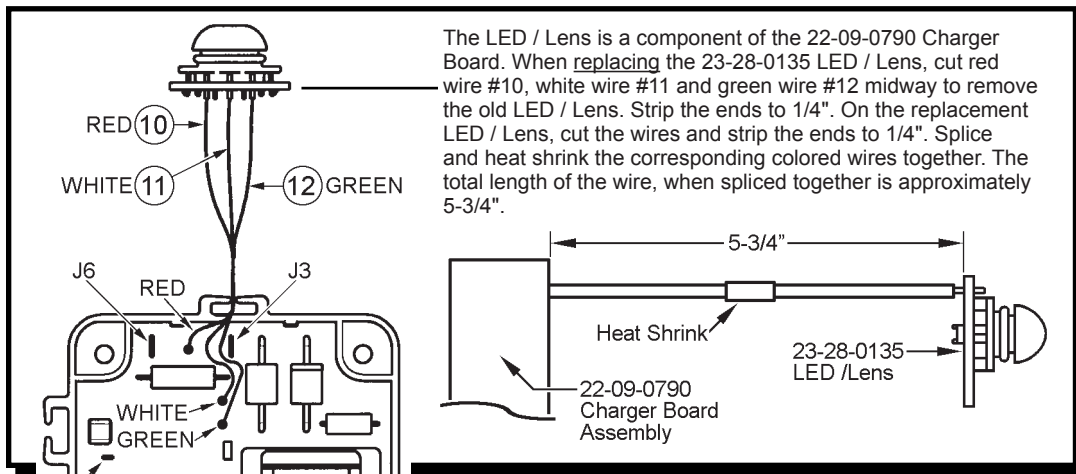

**23-74-1525
CHARGER TERMINAL
(3 ASSEMBLIES)**

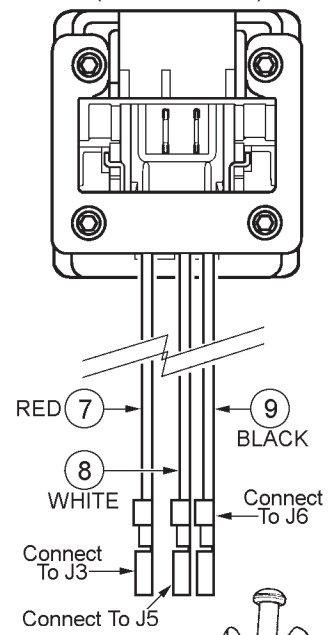

**(2 BLACK LEADWIRE ASSEMBLIES)
23-94-1315**

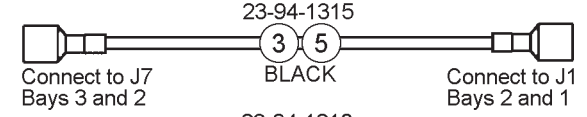

**(2 WHITE LEADWIRE ASSEMBLIES)
23-94-1210**

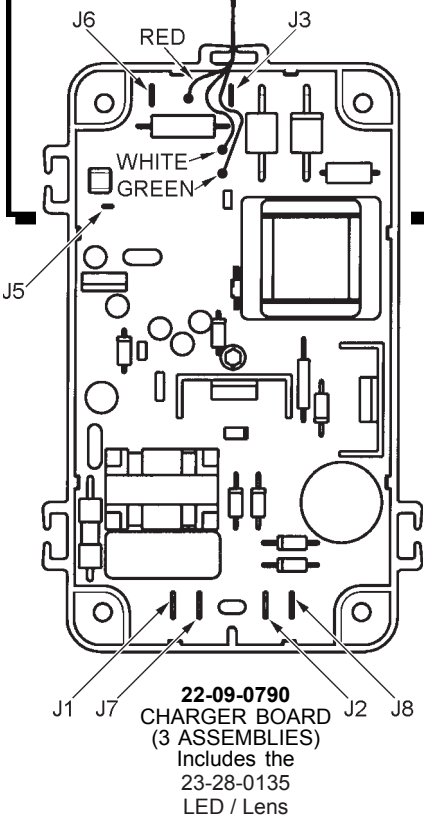
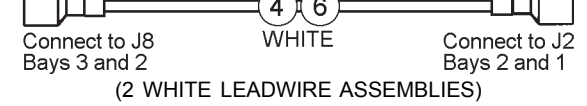

Place the **first** charger board in the middle, lower position (bay 2). Place the other two charger boards into bays 1 & 3.

*Route wires 7, 8 and 9 from the charger terminals through the wire traps, as shown, and attach to the charger boards.

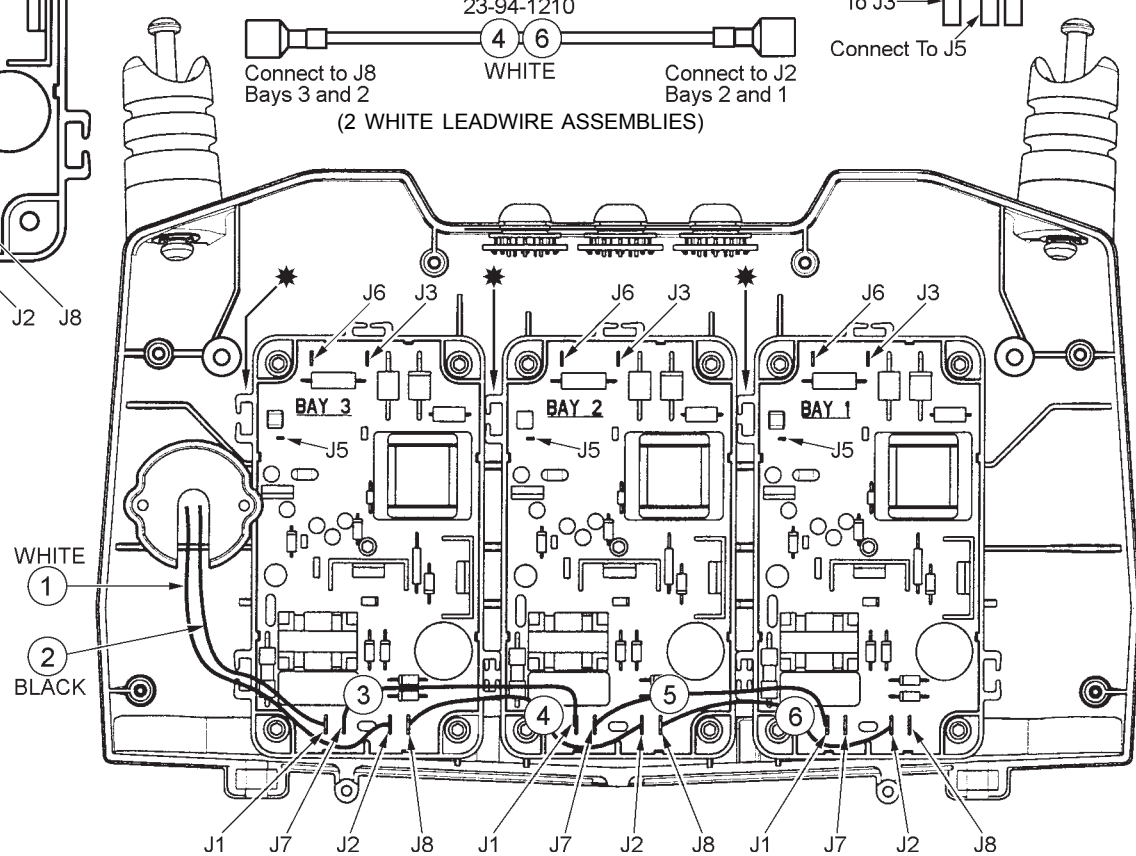

WIRING SPECIFICATIONS

Wire No.	Wire Color	Origin or Part No.	Terminals, Connectors and End Wire Preparation
1	White	22-64-1080	Component of the cord set. Connect to J2 on Bay 3.
2	Black	22-64-1080	Component of the cord set. Connect to J1 on Bay 3.
3	Black	23-94-1315	Component of the leadwire assembly. Connect to J7 on Bay 3 / Connect to J1 on Bay 2.
4	White	23-94-1210	Component of the leadwire assembly. Connect to J8 on Bay 3 / Connect to J2 on Bay 2.
5	Black	23-94-1315	Component of the leadwire assembly. Connect to J7 on Bay 2 / Connect to J1 on Bay 1.
6	White	23-94-1210	Component of the leadwire assembly. Connect to J8 on Bay 2 / Connect to J2 on Bay 1.
7	Red	23-74-1525	Component of the battery connector assembly. 3 assemblies. Connect to J3 on corresponding Bays 1, 2 and 3.
8	White	23-74-1525	Component of the battery connector assembly. 3 assemblies. Connect to J5 on corresponding Bays 1, 2 and 3.
9	Black	23-74-1525	Component of the battery connector assembly. 3 assemblies. Connect to J6 on corresponding Bays 1, 2 and 3.
10	Red	23-28-0135	Component of the LED/Lens. 3 assemblies. Service according to the instructions above.
11	White	23-28-0135	Component of the LED/Lens. 3 assemblies. Service according to the instructions above.
12	Green	23-28-0135	Component of the LED/Lens. 3 assemblies. Service according to the instructions above.