

Jig Saw - F 012 435 500 - 4355 TYPE 1

Item	Part Number	Description	Illustration	Price	Quantity	Price Group
2	2 610 346 335	Field 120V	1	-,-	1	28
3	2 610 910 152	Armature 120V	1	-,-	1	-
3/5	2 610 346 332	Fan	1	-,-	1	-
4	2 610 346 612	Toggle Switch	1	-,-	1	-
5	2 610 354 068	Power supply cord	1	-,-	1	-
13	2 610 351 348	Bushing	1	-,-	1	13
14	2 610 346 372	Bearing	1	-,-	1	13
16	2 610 320 548	Brush Holder	1	-,-	2	13
18	2 610 072 554	Dowel pin	1	-,-	1	11
22	2 610 346 316	Protective Cap	1	-,-	1	13
23	2 610 346 317	Cam	1	-,-	1	11
24	2 610 346 319	Lever	1	-,-	1	-
26	2 610 346 330	Counter Weight	1	-,-	1	16
33	2 610 346 385	Base	1	-,-	1	21
34	2 610 346 793	Spring	1	-,-	1	11
36	2 610 350 360	Felt Seal	1	-,-	1	-
42	2 610 326 529	Sleeve	1	-,-	1	13
43	2 610 346 351	Plate	1	-,-	1	11
45	2 610 346 381	Nut	1	-,-	1	11
46	2 610 346 386	Washer	1	-,-	1	11
51	2 610 346 359	Pipe	1	-,-	1	11
60	2 610 313 518	Screw	1	-,-	9	13
61	2 610 327 772	Screw	1	-,-	1	11
63	2 610 346 374	Screw	1	-,-	1	11
64	2 610 016 828	Disc	1	-,-	1	-
65	2 610 027 445	Washer	1	-,-	1	11
66	2 610 901 970	Screw and washer assembly	1	-,-	1	11
67	2 610 346 380	Washer	1	-,-	1	11
68	2 610 346 349	Cover	1	-,-	1	13
73	2 610 038 850	Connecting Cable 45 MM	1	-,-	2	11
74	2 610 038 670	Cable 180 MM	1	-,-	1	13
75	2 610 038 920	Connecting Cable 210 MM	1	-,-	1	11
84	2 610 321 605	Bearing Pedestal	1	-,-	2	13

Item	Part Number	Description	Illustration	Price	Quantity	Price Group
85	2 610 326 586	Washer	1	-,-	1	11
99	2 610 001 643	Hexagon Socket Screw Key 1/8"	1	-,-	1	11
801	2 610 910 179	Housing	1	-,-	1	-
810	2 610 321 617	Carbon-Brush Set	1	-,-	1	24
825	2 610 346 363	Conversion Gear	1	-,-	1	-
827	2 610 346 342	Bearing Housing	1	-,-	1	-
832	2 610 346 370	Rotary Knob	1	-,-	1	-
837	2 610 910 104	Plunger Bar	1	-,-	1	-

Illustration - Type E

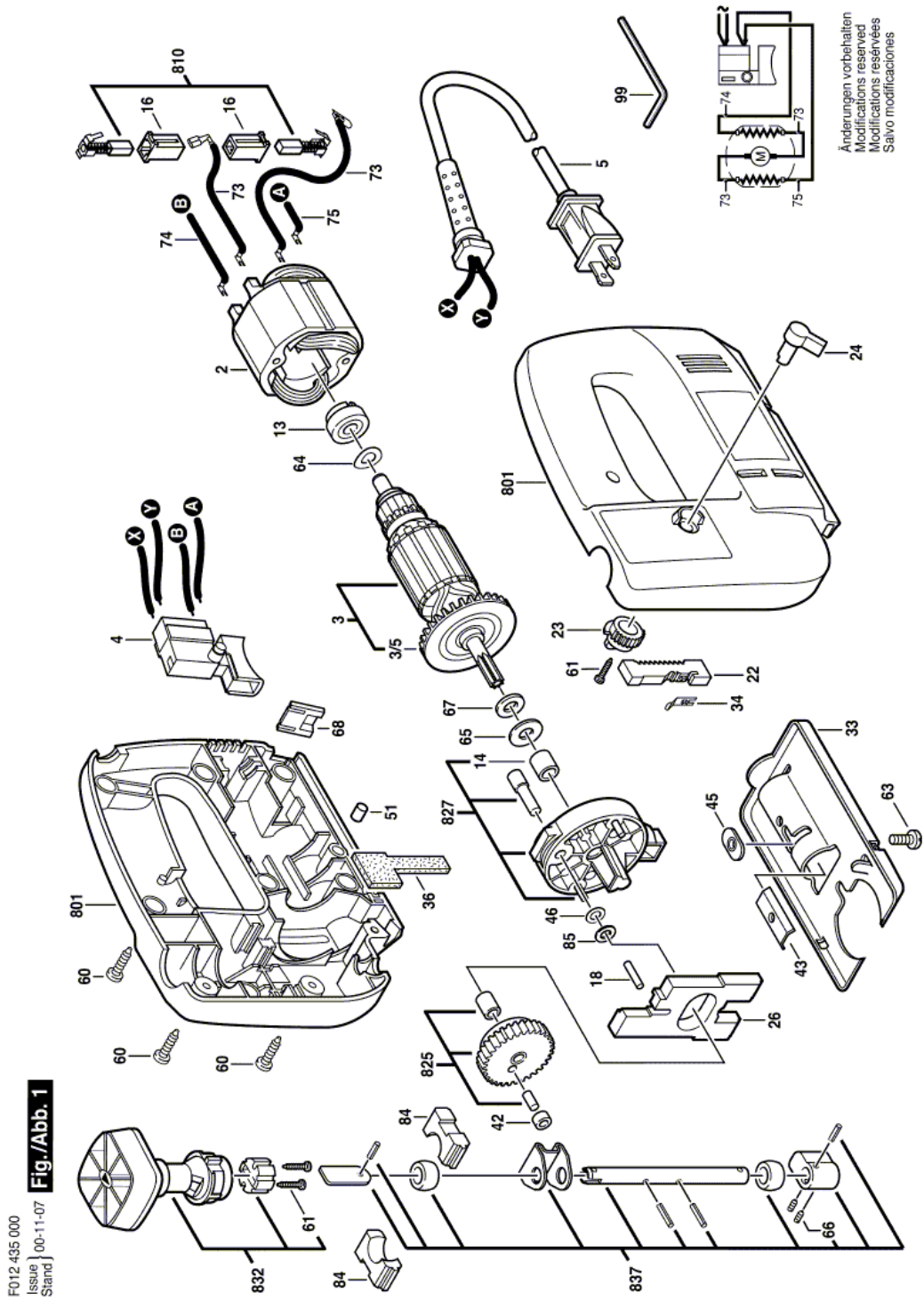

Information subject to change without further notice.