



34-778L, 34-783L, 36-820L, 36-821L,
36-878L, 36-883L, 36-884L, 36-951,
& 36-953

**UNISAW® LEFT TILT
10" TILTING ARBOR SAW**

CS-4K-13

PART NO. 422-40-651-0015

DATE: 06-08-04

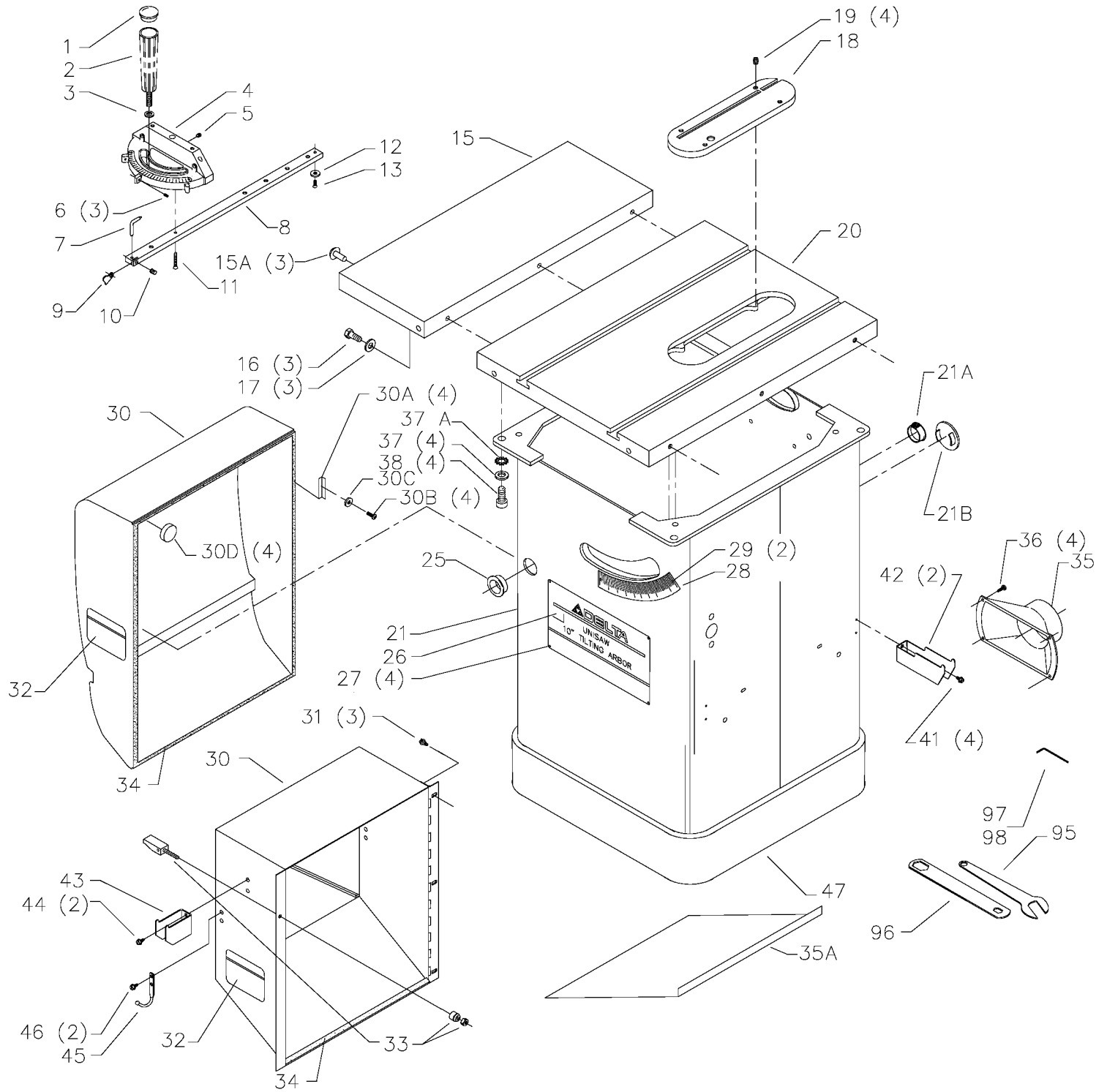

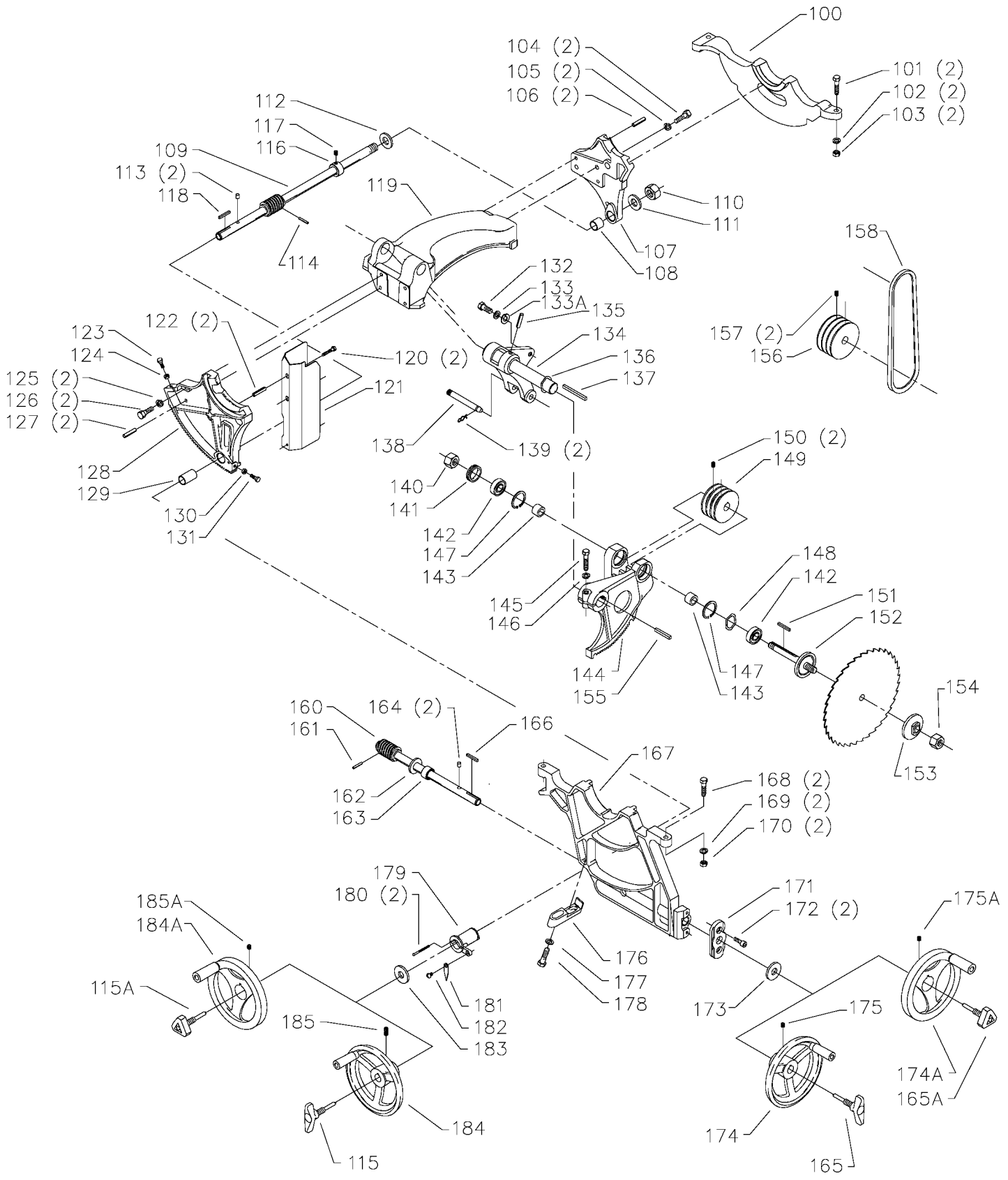

36-827
LEFT TILT BLADE GUARD

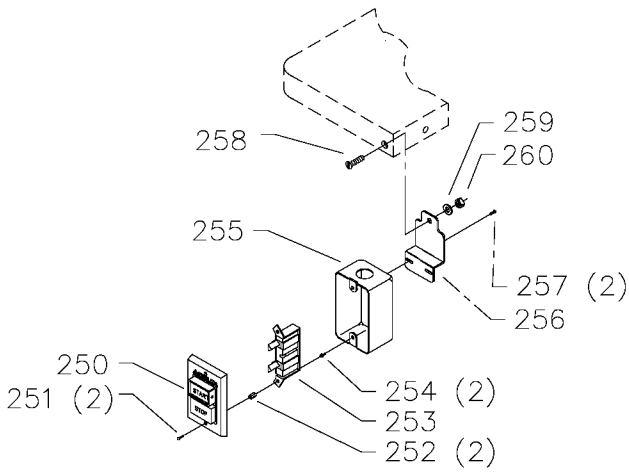
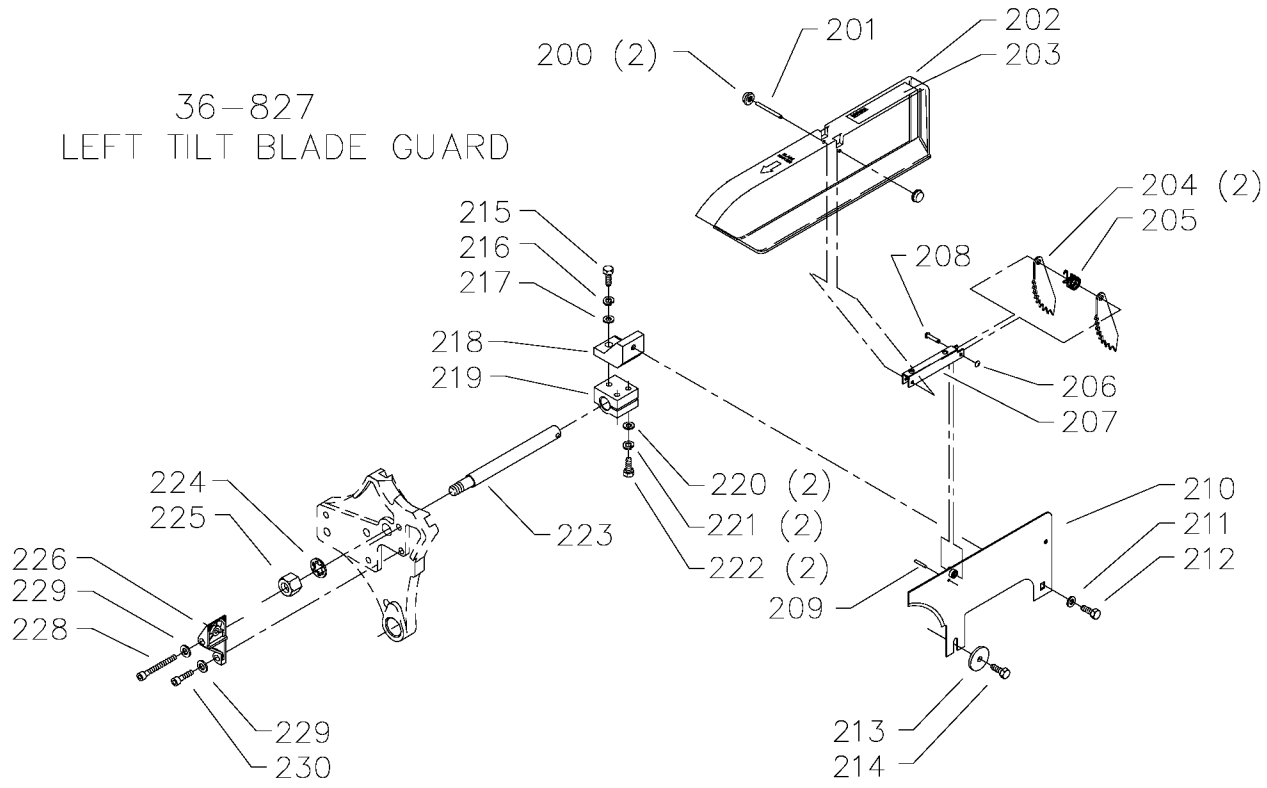

FOR USE WITH
LVC MODELS ONLY

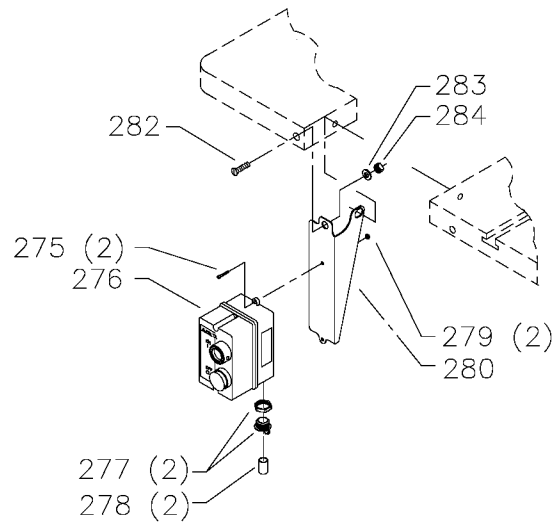

FOR (GPE) MODELS ONLY

FENCE OPTIONS

DELTA 52" UNIFENCE SAW GUIDE

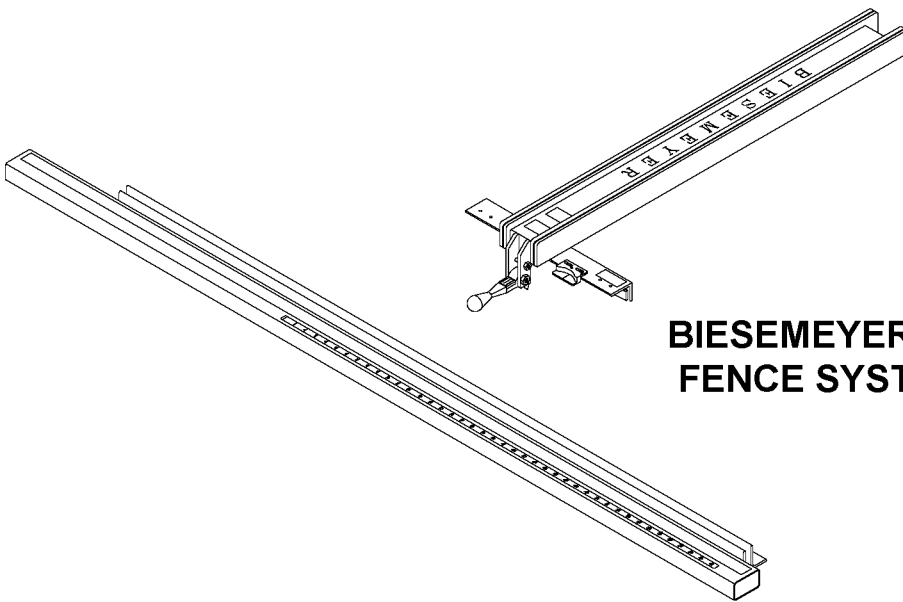
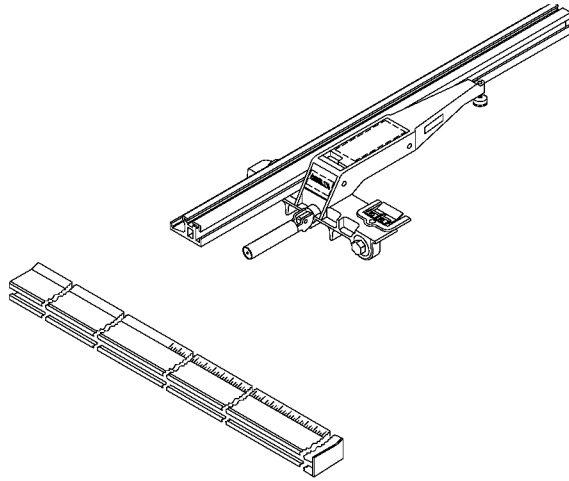

BIESEMEYER T-SQUARE FENCE SYSTEM

Parts List for 36-878L Type 2

Item Number	Part Number	Description	Qty Required
1	422020740001S	HOLE PLUG	1
2	422020600003S	HANDLE	1
3	904070105555S	FIBRE WSHR	1
4	422013550004	MITER GAGE BODY	1
4	34-895	MITER GAUGE	1
5	901041501181S	SET SCREW	1
6	901041509428S	SET SCREW	3
7	422010750001S	POINTER	1
8	34-895	MITER GAUGE	1
9	422010880004S	STOP LINK	1
10	901041501181S	SET SCREW	1
11	422011120001S	SCREW	1
12	422040720001S	PLATE	1
13	901020305750S	MACHINE SCREW	1
15	A24617S	10INUNIV WING	1
15	438010110077S	PLUG	3
16	901010609964	SCREW	3
17	904100312097S	SPECIAL WASHER	3
18	36-861	STD INSERT LT UNI	1
19	901044615297	SCREW	4
20	422403910001S	TABLE	1
21	422403180010	CABINET ASSY	1
21	901110200834S	CARRIAGE BOLT	1
21	902015031514	FLANGED HEX NUT	1
25	438010110021	INSULATOR	1
26	422041370011	NAMEPLATE	1
27	1087794	RIVET	4

Parts List for 36-878L Type 2

Item Number	Part Number	Description	Qty Required
28	422401320002	TILT SCALE	1
29	1087794	RIVET	2
30	422043310014	MOTOR COVER	1
30	422041220005S	SPRING CLIP	4
30	422041220004	SPRING CLIP	4
30	901024531123S	SCREW	4
30	904010131868S	WASHER	1
30	410090160004S	BUMPER	4
32	000000-00	No Longer Available	1
34	400064160003	GASKET	1
34	400064160001	GASKET	1
34	400064160001	GASKET	1
35	406120260001S	DUST CHUTE	1
36	901052131498	SCREW	4
37	904100312097S	SPECIAL WASHER	4
37	904030301771S	WASHER	1
38	901030101487	SCREW	4
41	901052131498	SCREW	4
42	422350140002S	RIP FENCE HOLDER	2
47	422043050001	SUB BASE	1
95	955010501472	OPEN-END WRENCH	1
96	422391010001S	BOX-END WRENCH	1
97	955030100001	1/4 HEX WRENCH	1
98	955030102155	5/64 HEX WRENCH	1
100	422040140051S	TRUNNION BRACKET	1
101	901010600682	CAP SCREW	2
102	904020201704S	LOCK WASHER	2

Parts List for 36-878L Type 2

Item Number	Part Number	Description	Qty Required
103	902010101207	HEX NUT	2
104	901030100775S	CAP SCREW	2
105	904020201704S	LOCK WASHER	2
106	905010102734	ROLL PIN	2
107	422403950002	REAR TRUNNION	1
108	920750113934	BEARING	1
109	422044065002	RAISING SHAFT	1
109	A09527S	SS/A-ELEV SHAFT/GEAR	1
110	902012101036S	HEX NUT	1
111	904010213577S	FIBER WASHER	1
112	904010213577S	FIBER WASHER	1
113	422040740001S	PLUG	2
114	905010102706S	ROLL PIN	1
115	422044120009S	LOCK KNOB	1
116	434014040001	COLLAR W SCRW	1
117	901041500206	SET SCREW	1
118	927030102650S	KEY	1
119	000000-00	No Longer Available	1
120	901010600613	MACHINE SCREW	2
121	422400360001S	DEFLECTOR	1
122	422041045005	SLEEVE	2
123	SSF-616-ZN	SCREW .313-24X1.00 H	1
124	902010201228	HEX JAM NUT	1
125	904020201704S	LOCK WASHER	2
126	901030100775S	CAP SCREW	2
127	905010102734	ROLL PIN	2
128	422403950001	FRONT TRUNNION	1

Parts List for 36-878L Type 2

Item Number	Part Number	Description	Qty Required
129	920750113935S	BUSHING	1
130	902010201228	HEX JAM NUT	1
131	SSF-616-ZN	SCREW .313-24X1.00 H	1
132	901010600664S	CAP SCREW	1
133	904100312097S	SPECIAL WASHER	1
133	904030301771S	WASHER	1
134	422403140004	MOTOR BRACKET	1
135	905010105072	ROLL PIN	1
136	928060114128S	SPRING WASHER	1
137	927030102657S	KEY	1
138	422040715001S	STEEL PIN	1
139	422040795001S	SPRING CLIP	2
140	902012009847S	SPECIAL NUT	1
141	902070207176S	BEARING CLOSURE NUT	1
142	1086894S	BEARING	2
143	422041040002S	SPACER	2
144	422403140003S	ARBOR BRACKET	1
144	422403140002	ARBOR BRACKET ASSY	1
145	901010603102S	CAP SCREW	1
146	904020201704S	LOCK WASHER	1
147	904151017147S	RET RING	2
148	928060207382S	LOAD SPRING	1
149	422041300003S	ARBOR PULLEY	1
150	A10686	SCREW	2
151	927030202660S	KEY	1
152	422403030002S	ARBOR & FLANGE	1
153	422041035001S	FLANGE	1

Parts List for 36-878L Type 2

Item Number	Part Number	Description	Qty Required
154	902012012571S	HEX NUT	1
155	927030102653S	KEY	1
156	41-644	HD 3GROOVE PULLY	1
157	A10686	SCREW	2
158	5140043-25	3V-BLTS 4L 261/16	1
160	422044065001S	TILT SHAFT W/WORM	1
161	905010102706S	ROLL PIN	1
162	904010213577S	FIBER WASHER	1
163	904100314509S	COLLAR	1
164	422040740001S	PLUG	2
165	422044120009S	LOCK KNOB	1
166	927030102650S	KEY	1
167	422400140001S	FRONT BRACKET	1
168	901010600682	CAP SCREW	2
169	904020201704S	LOCK WASHER	2
170	902010101207	HEX NUT	2
172	901030408016S	CAP SCREW	1
173	904070105569	FIBRE WASHER	1
174	422044000005S	HANDWHEEL	1
174	422044000005S	HANDWHEEL	1
175	901041500206	SET SCREW	1
175	901041500206	SET SCREW	1
176	422040550006	GUIDE BLOCK	1
177	904100312097S	SPECIAL WASHER	1
178	901010600681	CAP SCREW	1
179	422040142008S	POINTER BRACKET	1
180	919714	SHEET MTL SCR	2

Parts List for 36-878L Type 2

Item Number	Part Number	Description	Qty Required
181	422400750001	POINTER	1
182	901061103036	SELF-TAP SCREW	1
183	904070105569	FIBRE WASHER	1
184	422044000005S	HANDWHEEL	1
184	422044000005S	HANDWHEEL	1
185	901041500206	SET SCREW	1
185	901041500206	SET SCREW	1
200	1086388S	PUSH NUT CAP	2
201	1087811S	PIN	1
202	422403540004	LFT TILT BLADE GUARD	1
202	422403540003	BLADE GUARD ASSY	1
202	736827	LT-SEE-THRU GUARD	1
203	422407540002S	WARNING LABEL	1
204	422160470001S	KICK BACK FINGER	2
205	1086353S	SPRING	1
206	1086387S	PUSH NUT	1
207	1086337S	PIVOT BRACKET	1
208	422040710007S	PIN	1
209	905010106729S	PIN	1
210	422040860002S	SPLITTER W/BUSHING	1
211	904010101620S	WASHER	1
212	901010600649S	CAP SCREW	1
213	422030720001S	PLATE	1
214	901010600649S	CAP SCREW	1
215	901010600649S	CAP SCREW	1
216	904020101703S	LOCK WASHER	1
217	904010101620S	WASHER	1

Parts List for 36-878L Type 2

Item Number	Part Number	Description	Qty Required
218	422040140052S	SPLITTER BRACKET	1
219	422040140053S	BRACKET	1
220	904010101620S	WASHER	2
221	904020101703S	LOCK WASHER	2
222	901010600649S	CAP SCREW	2
223	422040890003S	SUPPORT ROD	1
224	904030201751	LOCK WASHER	1
225	902010201226S	NUT	1
226	422400140005S	SPLITTER BRACKET	1
228	901030131698S	CAP SCREW	1
229	904010101620S	WASHER	2
230	901030100757S	CAP SCREW	1
250	1340100	SWITCH COVER ASSY	1
251	901020100567S	MACHINE SCREW	2
252	402071045007S	SPACER	2
253	438010170101S	SWITCH	1
254	402071115002S	STUD	2
255	438010010036	SWITCH BOX	1
256	422400140006	MOUNTING BRACKET-LVC	1
257	901051631126S	SCREW	2
258	901030331881	SCREW	1
259	904010101620S	WASHER	1
260	902010101300S	HEX NUT	1
275	901024531123S	SCREW	2
276	438013170153	STARTER	1
276	438013170154	STARTER	1
277	438010040007S	CLAMP	2

Parts List for 36-878L Type 2

Item Number	Part Number	Description	Qty Required
278	438010110054S	INSULATOR SLEEVE	2
279	902012931513S	KEPS NUT	2
280	422400140014	BRACKET	1
282	901030331881	SCREW	1
283	904010101620S	WASHER	1
284	902010101300S	HEX NUT	1
846	422047250002S	GUARD MT	1
846	422407250001	HARDWARE PACK	1
846	422047250006	HARDWARE PACK	1
856	000000-00	No Longer Available	1
856	438023146203	1PH 5HP 230V MOTOR	1
856	000000-00	No Longer Available	1
856	000000-00	No Longer Available	1
856	438023146204	MOTOR - 1PH-3HP-230V	1
856	438023146203	1PH 5HP 230V MOTOR	1
856	438023146204	MOTOR - 1PH-3HP-230V	1
856	438023146205	3PH 5HP 230/460V MOT	1