

GUARD ASSY, EARLY MODELS ONLY
PRIOR TO SERIAL NUMBER 9602

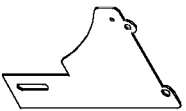

DETAIL A
CLOSED SLOT

GUARD ASSY, CURRENT MODELS ONLY
SERIAL NUMBER 9602 & HIGHER

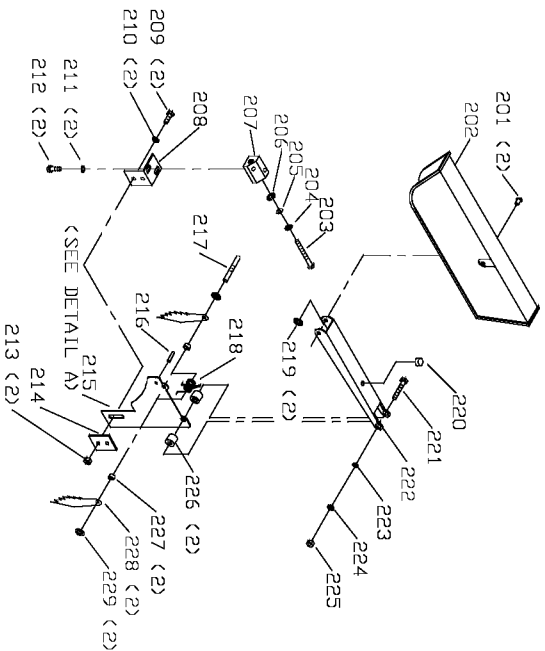
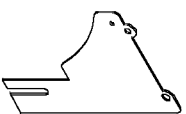
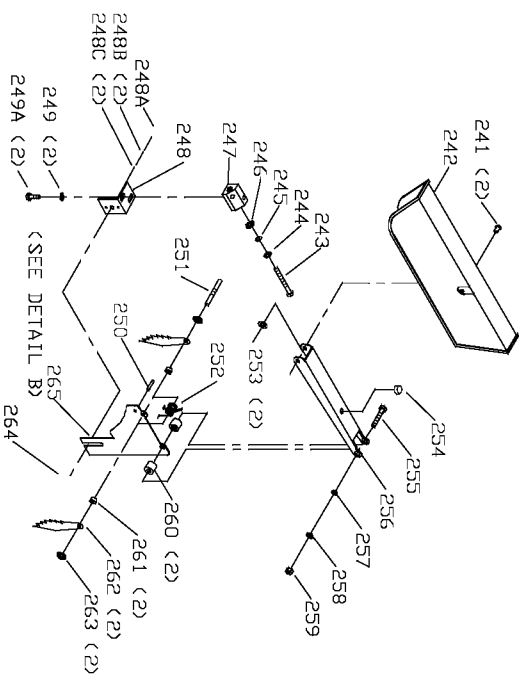

DETAIL B
OPEN SLOT

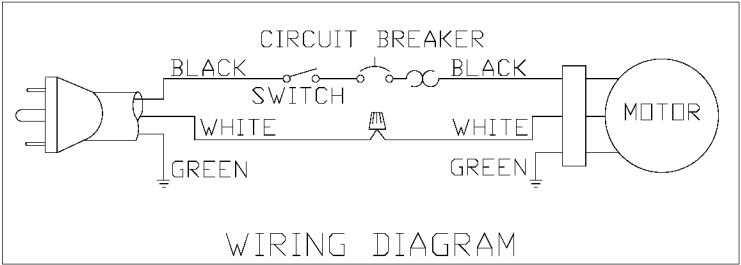
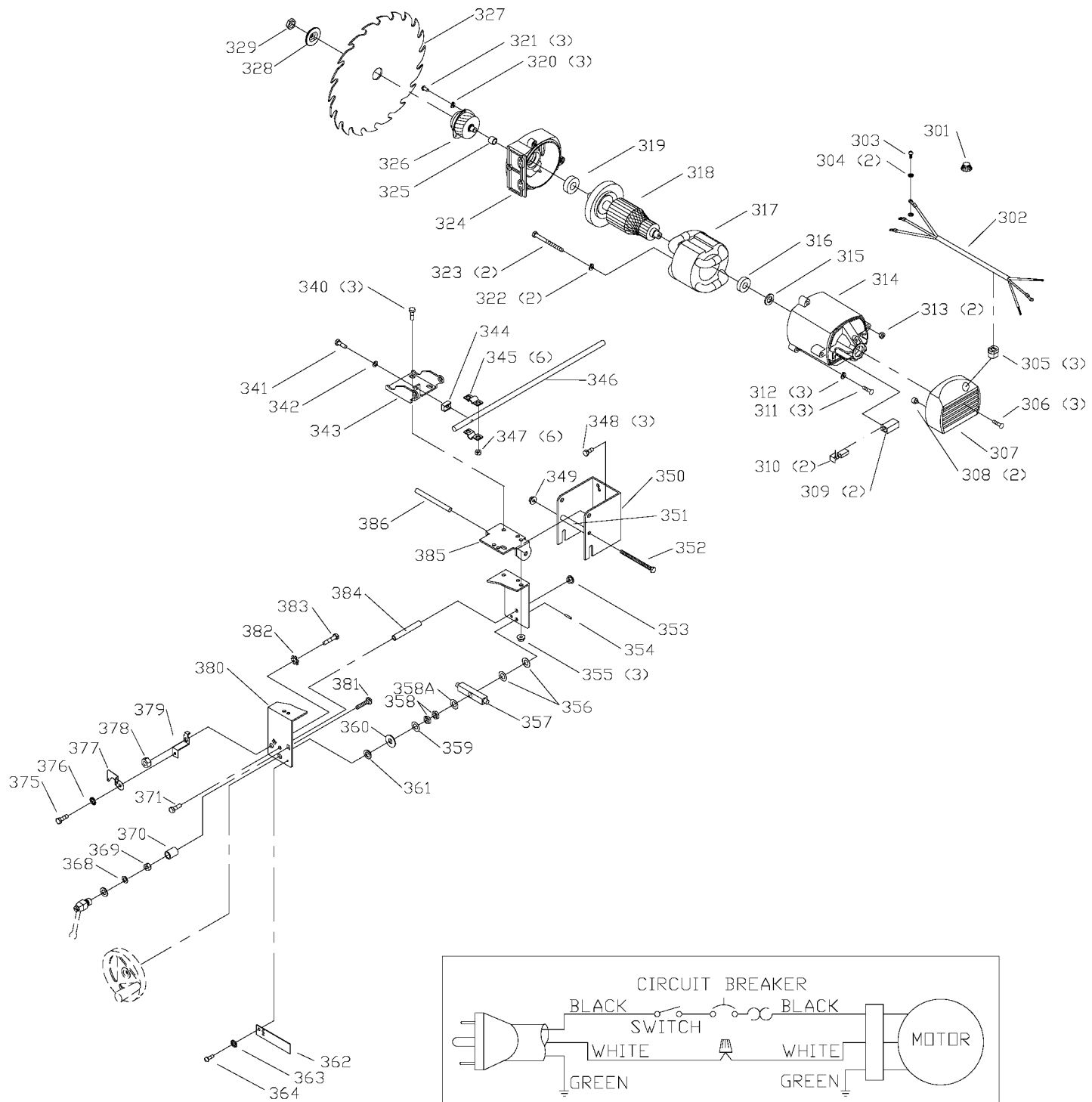

36-547 OUTFEED ROLLER SUPPORT

IS PROVIDED AS STANDARD EQUIPMENT WITH MODEL 36-546
 & AVAILABLE AS AN ACCESSORY FOR MODEL 36-545
 & AVAILABLE AS AN ACCESSORY FOR MODEL 36-540
 (MODEL 36-540 REQUIRES THE USE OF 36-519 STAND ASSY)

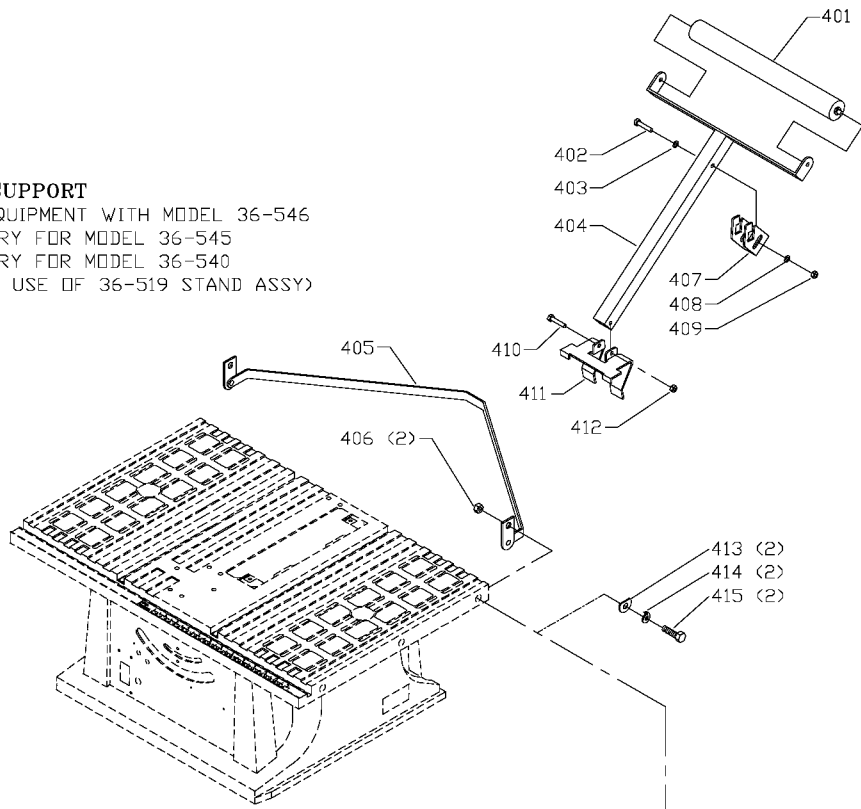

36-519 STAND ASSY

IS PROVIDED AS STANDARD EQUIPMENT
 WITH MODELS 36-546 & 36-545
 & AVAILABLE AS AN ACCESSORY
 FOR MODEL 36-540

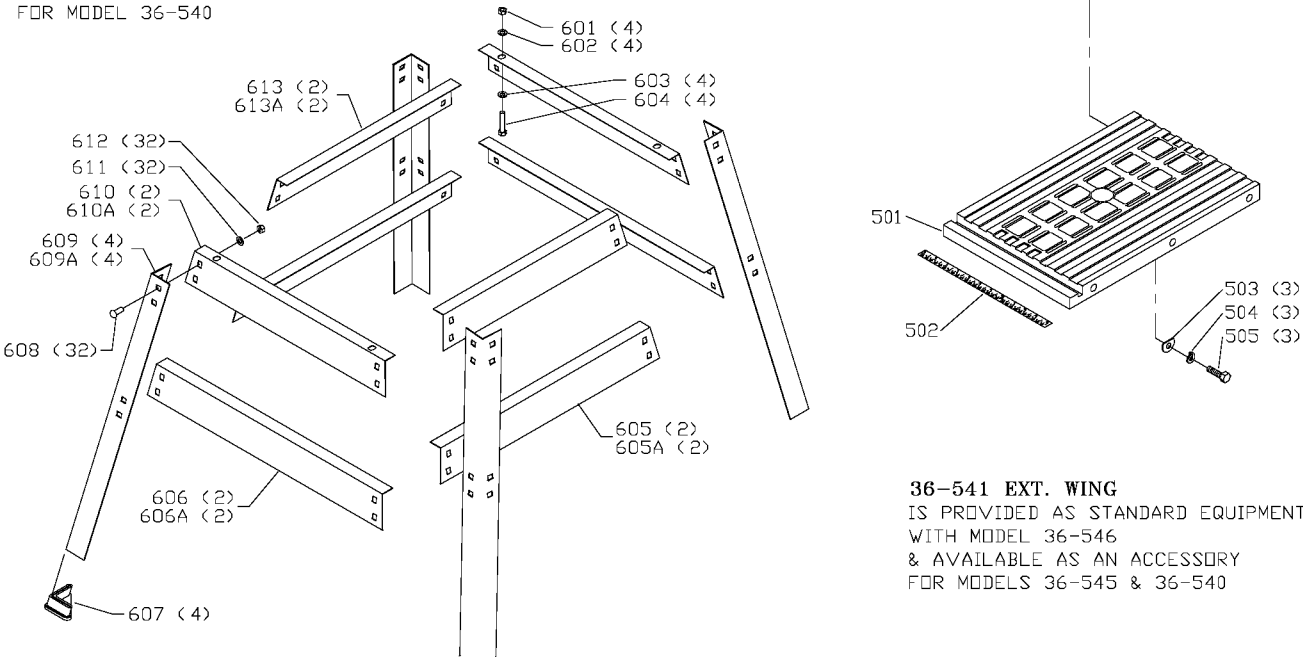

36-541 EXT. WING

IS PROVIDED AS STANDARD EQUIPMENT
 WITH MODEL 36-546
 & AVAILABLE AS AN ACCESSORY
 FOR MODELS 36-545 & 36-540

Parts List for 36-545 Type 2

Item Number	Part Number	Description	Qty Required
1	000000-00	No Longer Available	1
1	490591-00	FENCE ASSEMBLY	1
2	1246013	CAP SCREW	2
3	1313361	STAR WASHER	2
4	488855-00	SCREW	1
5	90511873	POINTER	1
6	1246118	ROLL PIN	1
7	489076-00	HANDLE	1
8	491964-00	NUT	1
9	488997-00	ECCENTRIC CAM	1
10	488998-00	ADJUSTING SCREW	1
11	489001-00	PIN	1
12	489000-00	PIN	1
13	490591-00	FENCE ASSEMBLY	1
14	489003-00	SPRING	1
15	1243501	SCREW	2
16	489005-00	SPRING PLATE	1
17	489006-00	PLATE	1
18	489007-00	SPRING	1
19	489008-00	REAR CLAMP	1
20	489009-00	SLIDE	1
21	489010-00	LOCK ROD	1
54	900060	TABLE INSERT	1
55	1340406	SCREW	2
56	489080-00	NUT	2
57	489082-00	FLAT HEAD SCREW	6
60	1346713	TABLE	1

Parts List for 36-545 Type 2

Item Number	Part Number	Description	Qty Required
61	901020100535	MACHINE SCREW	1
62	901020100513	MACHINE SCREW	1
63	491722-00	WARNING LABEL	1
64	000000-00	No Longer Available	1
70	90517470	MITER GAUGE	1
71	5140010-69	WASHER	1
72	904070105555S	FIBRE WSHR	1
73	90517470	MITER GAUGE	1
73	90517470	MITER GAUGE	1
74	902011201216	HEX NUT	3
75	90513860	SCREW	3
76	90517470	MITER GAUGE	1
77	90517470	MITER GAUGE	1
78	489563-00	SCREW	1
79	904010101609	STEEL WASHER	1
80	90517470	MITER GAUGE	1
81	90517470	MITER GAUGE	1
81	90517470	MITER GAUGE	1
82	90517470	MITER GAUGE	1
83	90517470	MITER GAUGE	1
83	90517470	MITER GAUGE	1
84	90517470	MITER GAUGE	2
87	1243501	SCREW	1
88	492056-00	WASHER	1
89	1346724	SPRING CLIP	1
90	1346725	BLOCK	1
91	1243569	NUT	1

Parts List for 36-545 Type 2

Item Number	Part Number	Description	Qty Required
92	1246140	FL WASHER	6
93	1346716	SCREW	6
94	492056-00	WASHER	4
95	1340406	SCREW	4
96	1343223	FT HD SCREW	5
97	489097-00	SLEEVE	1
98	1330398	SCREW	2
99	000000-00	No Longer Available	1
100	1343526	SCREW	3
101	904070105555S	FIBRE WSHR	1
102	5140010-69	WASHER	1
103	1346717	LEVER ASSY	1
104	489101-00	THREADED ROD	1
105	489322-00	HANDWHEEL	1
106	1342035	SCREW	1
107	491731-00	HANDLE	1
108	490375-00	SCREW	1
109	489105-00	SWITCH	1
110	489105-00	SWITCH	1
111	1313229	SWITCH W/PLATE	1
112	489107-00	TOOTH WASHER	1
113	1313228	NUT	1
114	1343526	SCREW	2
115	1345695	CORD CLAMP	1
116	489109-00	SWITCH COVER	1
117	489110-00	RUBBER FOOT	4
118	1346714	BASE	1

Parts List for 36-545 Type 2

Item Number	Part Number	Description	Qty Required
119	1346715	SCREW	4
120	489113-00	BASE PLATE	1
121	491722-00	WARNING LABEL	1
130	489578-00	OPEN-END WRENCH	1
131	1313197	WRENCH BOX END	1
132	1246117	FL HD SCREW	2
133	1310210	LOCKWASHER	2
134	1243569	NUT	2
135	489116-00	LEAD,JUMPER	1
136	90514088	CORD SET	1
201	489118-00	RIVET	2
202	492720-00	GUARD	1
202	000000-00	No Longer Available	1
204	489122-00	TOOTH WASHER	1
205	5140010-69	WASHER	1
206	904030301757S	LOCK WASHER	1
207	489124-00	SPLITTER BRACKET	1
208	000000-00	No Longer Available	1
209	901010600611S	CAP SCREW	2
210	904030301757S	LOCK WASHER	2
211	904030301757S	LOCK WASHER	2
212	901010600611S	CAP SCREW	2
213	489026-00	HEX NUT	2
214	1345739	PLATE	1
215	492607-00	SPLITTER	1
216	000000-00	No Longer Available	1
217	489023-00	PIN	1

Parts List for 36-545 Type 2

Item Number	Part Number	Description	Qty Required
218	489021-00	SPRING	1
219	489018-00	CLIP	2
220	489016-00	RUBBER BUMPER	1
221	5140081-98	SCREW	1
222	489017-00	SUPPORT	1
223	489204-00	FLAT WASHER	1
224	904030301757S	LOCK WASHER	1
225	489026-00	HEX NUT	1
226	489020-00	SPACER	2
227	489022-00	SPACER	2
228	489019-00	ANTI-KICKBACK FINGER	2
229	489018-00	CLIP	2
241	489118-00	RIVET	2
242	492720-00	GUARD	1
242	000000-00	No Longer Available	1
244	489122-00	TOOTH WASHER	1
245	5140010-69	WASHER	1
246	904030301757S	LOCK WASHER	1
247	489124-00	SPLITTER BRACKET	1
248	489125-00	SPLITTER BRACKET	1
248	1246015	CAP SCREW	1
248	904030301757S	LOCK WASHER	2
248	1310062	WASHER	2
249	904030301757S	LOCK WASHER	2
249	901010600611S	CAP SCREW	2
250	000000-00	No Longer Available	1
251	489023-00	PIN	1

Parts List for 36-545 Type 2

Item Number	Part Number	Description	Qty Required
252	489021-00	SPRING	1
253	489018-00	CLIP	2
254	489016-00	RUBBER BUMPER	1
255	5140081-98	SCREW	1
256	489017-00	SUPPORT	1
257	489204-00	FLAT WASHER	1
258	904030301757S	LOCK WASHER	1
259	489026-00	HEX NUT	1
260	489020-00	SPACER	2
261	489022-00	SPACER	2
262	489019-00	ANTI-KICKBACK FINGER	2
263	489018-00	CLIP	2
264	489127-00	WING NUT	1
265	492607-00	SPLITTER	1
301	488979-00	WIRE NUT	1
302	90514071	MOTOR CORD	1
303	488855-00	SCREW	1
304	1310210	LOCKWASHER	2
305	438010040062	HEYCO BUSHING 5/8	3
306	821057	PAN HEAD SCREW	3
306	1341235	SCREW	3
306	1341235	SCREW	3
307	489135-00	END CAP	1
308	1345702	PAD	2
309	1345704	BRUSH HOUSING	2
310	90512443	BRUSH	2
311	1310146	SCREW	3

Parts List for 36-545 Type 2

Item Number	Part Number	Description	Qty Required
312	488983-00	LOCK WASHER	3
313	488871-00	LOCK NUT	2
314	489139-00	MOTOR HOUSING	1
315	489141-00	WAVE WASHER	1
316	920080205352S	BEARING	1
317	489145-00	FIELD	1
318	489152-00	ARMATURE	1
319	400081390008	BEARING	1
320	488953-00	LOCK WASHER	3
321	1341235	SCREW	3
321	1341235	SCREW	3
322	488983-00	LOCK WASHER	2
323	562097-13	SCREW	2
324	489162-00	GEAR HOUSING	1
325	1345711	NEEDLE BEARING	1
326	492602-00	JACKSHAFT ASSEMBLY	1
328	489170-00	FLANGE	1
329	489171-00	ARBOR NUT	1
340	1349495	SCREW	3
341	901061631484	SCREW	1
342	904030301760	LOCKWASHER	1
343	489032-00	BRACKET	1
344	489174-00	SADDLE	1
345	489175-00	STRAP	6
346	489176-00	PIVOT ROD	1
347	489030-00	FLANGE NUT	6
348	489177-00	HEX FLANGE SCREW	3

Parts List for 36-545 Type 2

Item Number	Part Number	Description	Qty Required
349	489030-00	FLANGE NUT	1
350	488995-00	BRACKET ASSEMBLY	1
351	489035-00	SPACER	1
352	489048-00	HEX HEAD SCREW	1
353	489030-00	FLANGE NUT	1
354	1246119	ROLL PIN	1
355	489030-00	FLANGE NUT	3
356	904010312934S	WASHER	1
357	489190-00	BLOCK	1
358	489191-00	HEX NUT	1
358	000000-00	No Longer Available	1
359	489192-00	FIBER WASHER	1
360	904010317706	WASHER	1
361	489194-00	WAVE WASHER	1
362	489037-00	PLATE	1
363	904030301760	LOCKWASHER	1
364	901202416107	HEX HD SCR	1
368	5140010-69	WASHER	1
369	489026-00	HEX NUT	1
370	489031-00	SPACER	1
371	489048-00	HEX HEAD SCREW	1
375	901021403712	SCREW	1
376	904030301760	LOCKWASHER	1
377	491559-00	POINTER	1
378	902010101300S	HEX NUT	1
379	491559-00	POINTER	1
380	489034-00	BRACKET	1

Parts List for 36-545 Type 2

Item Number	Part Number	Description	Qty Required
381	901110200819	CARRIAGE BOLT	1
382	000000-00	No Longer Available	1
383	901010600629	SCREW	1
384	489036-00	SPACER	1
385	489033-00	MOUNTING PLATE	1
386	489027-00	SPRING PIN	1
401	000000-00	No Longer Available	1
401	000000-00	No Longer Available	1
402	1346205	HEX HEAD SCREW	1
403	1246140	FL WASHER	1
404	000000-00	No Longer Available	1
405	000000-00	No Longer Available	1
406	1343419	NUT	2
407	000000-00	No Longer Available	1
408	1246140	FL WASHER	1
409	1343642	LOCK NUT	1
410	1246128	CAP SCREW	1
411	000000-00	No Longer Available	1
412	1343642	LOCK NUT	1
413	1346213	SPECIAL WASHER	2
414	904020201704S	LOCK WASHER	2
415	1346212	SCREW	2
501	000000-00	No Longer Available	1
502	1345745	SCALE	1
503	1346213	SPECIAL WASHER	3
504	904020201704S	LOCK WASHER	3
505	901010600642	CAP SCREW	3

Parts List for 36-545 Type 2

Item Number	Part Number	Description	Qty Required
600	000000-00	No Longer Available	1
601	491964-00	NUT	4
602	491956-00	WASHER	4
603	491956-00	WASHER	4
604	489303-00	HEX HEAD SCREW	4
605	000000-00	No Longer Available	2
605	000000-00	No Longer Available	2
606	000000-00	No Longer Available	2
606	000000-00	No Longer Available	2
607	427990480001	FOOT	1
608	1313325	SCREW	32
609	000000-00	No Longer Available	4
609	000000-00	No Longer Available	4
610	000000-00	No Longer Available	2
610	000000-00	No Longer Available	2
611	491956-00	WASHER	32
612	491964-00	NUT	32
613	491964-00	NUT	2
613	899967	BRACKET	2
856	000000-00	No Longer Available	1
856	489129-00	MOTOR ASSEMBLY	1