

31.07.2015 |

Cordless Drill Driver - F 012 286 600 - 2866

Item	Part Number	Description	Illustration	Price	Quantity	Price Group
7	2 609 100 342	Cover	1	-,-	1	11
25	1 619 X00 090	Chuck	1	-,-	1	33
91	2 607 335 513	Battery Pack 18V, 1,2Ah, NiCd	1	-,-	1	47
109	2 609 100 190	Bit holder	1	-,-	1	16
110	2 610 916 434	Metal Detector	1	-,-	1	35
652	2 609 100 101	Protective Cap	1	-,-	1	16
653	2 607 225 367	Fast Charger USA 120/9,6V-18V, 3h	1	-,-	1	31
800	F 012 286 600	Cordless Drill Driver 18V	1	-,-	1	-
807	2 609 110 721	Countersunk-Head Screw M5x20	1	-,-	1	11

Illustration - Type E

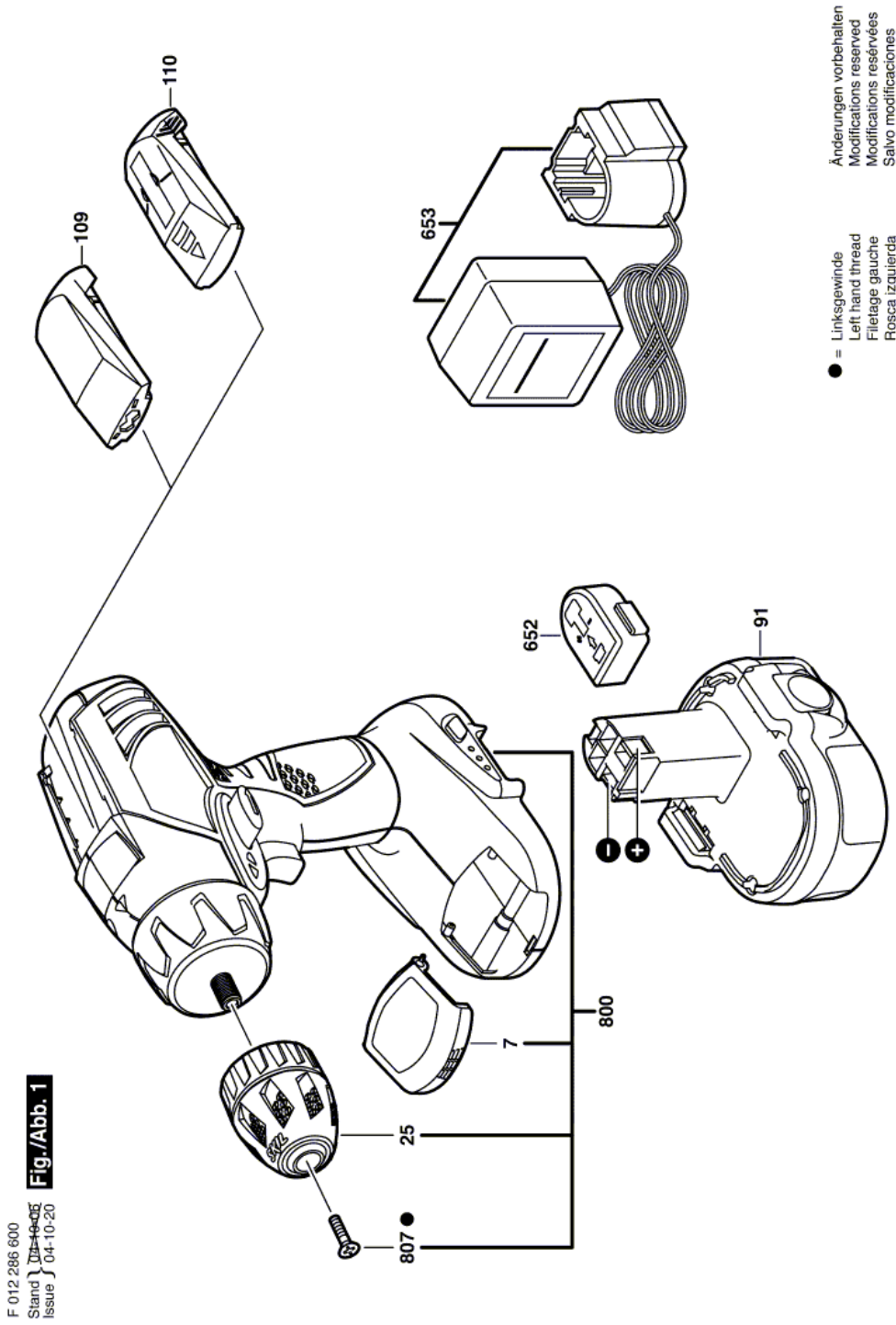

Information subject to change without further notice.