



SERVICE PARTS LIST

BULLETIN NO.
55-26-2653

SPECIFY CATALOG NO. AND SERIAL NO. WHEN ORDERING PARTS		REVISED BULLETIN 55-26-2652	DATE Mar. 2015
M18 FUEL™ 1/4" Hex Impact Driver			
CATALOG NO.	2653-059	STARTING SERIAL NO.	F20D
			WIRING INSTRUCTION SEE PAGE 2

IMPORTANT NOTE: Gearcase end cap #25 is LEFT HAND THREAD!

As an aid to assembly, carefully lower the complete front end of tool (gearcase/impacting system) onto the gearcase end cap. Gently hand tighten front end assembly onto gearcase end cap. Be careful not to cross-thread! Once installed by hand, seat gearcase end cap with a good adjustable wrench using light pressure. Do not over tighten!

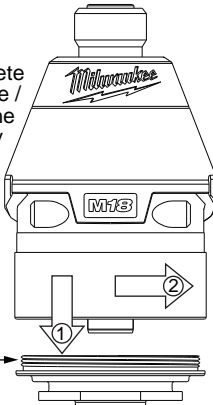

LEFT HAND THREAD

NOTE: Components of the impacting assembly (61) can drop out of the gearcase (57). Care must be taken to hold those elements in place when assembling onto the gearcase end cap (25).

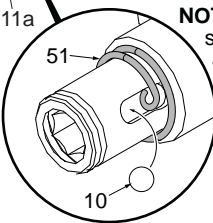
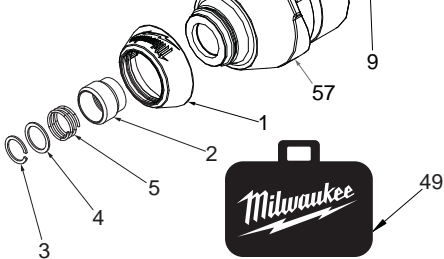
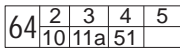
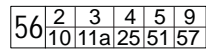

NOTE: Place anvil spring (51) onto anvil (11a) with curled end inserted in slot of anvil as shown. Place ball (10) in anvil slot in front of spring.

★ = Part number change from previous service parts list.

EXAMPLE:
Component Parts (Small #)
Are Included When Ordering
The Assembly (Large #).

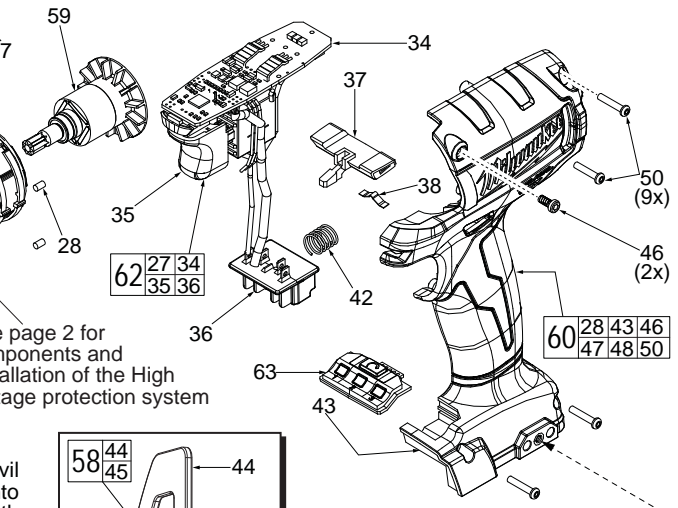
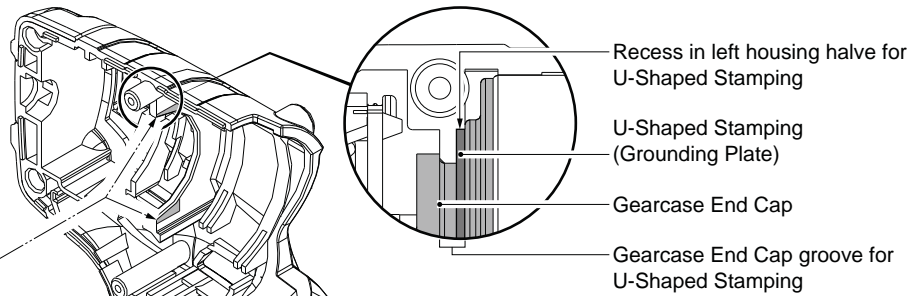

FIG.	PART NO.	DESCRIPTION OF PART	NO. REQ.
1	31-12-2653	Rubber Cap	(1)
2	45-22-0012	Sleeve	(1)
3	34-60-0005	Retaining Ring	(1)
4	45-88-0022	Washer	(1)
5	40-50-0056	Spring	(1)
9	45-88-2653	Plastic Washer	(1)
10	02-02-1100	4.0mm Steel Ball	(1)
11a	-----	1/4" Hex Anvil	(1)
12	02-02-1300	5mm Steel Ball	(1)
19	02-02-0180	4.7mm Steel Ball	(2)
24	-----	Ring Gear	(1)
25	44-66-2653	Gearcase End Cap with Ball Bearing	(1)
27	-----	Stator Assembly	(1)
28	45-30-2653	Rubber Slug	(4)
34	-----	PCBA	(1)
35	23-66-2653	On-Off Switch	(1)
36	-----	Terminal Block Assembly	(1)
37	45-24-2653	Fwd/Rev Shuttle	(1)
38	40-50-1135	Spring	(1)
42	40-50-1090	Spring	(1)
43	-----	Left Handle Halve	(1)
44	-----	Belt Hook	(1)
45	06-82-0130	6-32 x 5/16" Pan Hd. T-15 Machine Scr	(1)
46	06-82-2653	M3.5 x 8mm Pan Hd. Plastite Screw	(2)
47	-----	Right Handle Halve	(1)
48	-----	Service Nameplate (Not Shown)	(1)
49	42-55-2653	Carrying Case	(1)

FIG.	PART NO.	DESCRIPTION OF PART	NO. REQ.
50	06-82-7236	4-20 x 5/8" Pan Hd. Plastite T-10 Scr	(9)
51	40-50-0018	Anvil Spring	(1)
56	14-30-2653	Gearcase Assembly	(1)
57	28-50-2653	Front Gearcase	(1)
58	42-70-2653	Belt Clip Assembly	(1)
59	16-07-2673	Rotor Assembly	(1)
60	31-44-2670	Handle Assembly	(1)
61	14-30-2655	Impacting Assembly	(1)
★ 62	14-20-2654	Electronics Assembly	(1)
63	45-24-2655	Speed Selector	(1)
64	42-06-0020	1/4" Hex Anvil Assembly	(1)
70	23-94-2115	U-Shaped Stamping/Wire Kit (Page 2)	(1)

- FIG. LUBRICATION (Type 'J' Grease, No. 49-08-4220):**
- 10,11a Lightly coat front washer surface of anvil (11a) with grease, place a dab in the ball slot of anvil and in needle bearing inside the anvil.
 - 24,61 Lightly coat the I.D. of the ring gear (24) and the center of the planet gears of impacting assembly with grease.
 - 57 Coat inside of bushing inside front gearcase with grease.
 - 59 Coat pinion of rotor assembly (59) with grease.

For ease of removal and installation of the High Voltage protection system, it may be necessary to remove the electronic/gearcase assemblies from the left housing halve.



Trim any excess wire stranding. Use a minimal amount of solder.

Slide heat shrink tubing over soldered area and shrink with heat gun.

There may be heat shrink tubing present on the existing negative battery terminal that must be carefully trimmed away prior to soldering on the HV wire. Use a thin piece of electrical tape after soldering.

1. Place wire through hole on small tab of U-Shaped Stamping. Twist metal strands to temporarily hold wire to stamping. Trim any excess wire stranding. Be sure to position wire straight down at the 6:00 position. Secure wire to stamping with a minimal amount of solder to the strands. **NOTE:** Use just enough solder to hold the High Voltage wire in place. **Excessive solder can directly affect the positioning of the top housing halve!**
2. Feed heat shrink tubing over wire and slide up over soldered tab. Use a heat gun to heat tubing to tighten/shrink around the soldered tab.
3. Position the HV wire to the left side, behind the PCBA and behind the fwd./rev. shuttle.
4. Place U-Shaped Stamping onto groove of gearcase end cap with small tab/wire positioned at the bottom. Be sure the U-Shaped Stamping is properly seated in the recess of the left housing halve. (See detail above).
5. Take loose end of kit wire and place metal wire strands onto negative terminal of battery terminal block (front right side with black wire attached to it). **NOTE:** Heat shrink tubing may have to be carefully removed. Secure that end with a minimal amount of solder. Use a small piece of electrical tape to wrap around the black negative wire and the black HV wire.
6. Press all electronic components in place and route all wires in left housing halve according to wiring diagram. Be sure all mechanical and electrical components are firmly seated. Be sure all wires are pressed firmly down in traps. Be sure that fwd./rev. shuttle and spring are reinstalled and function properly.
7. Carefully install Right Housing Halve being sure that there are no interferences. Secure with existing screws.

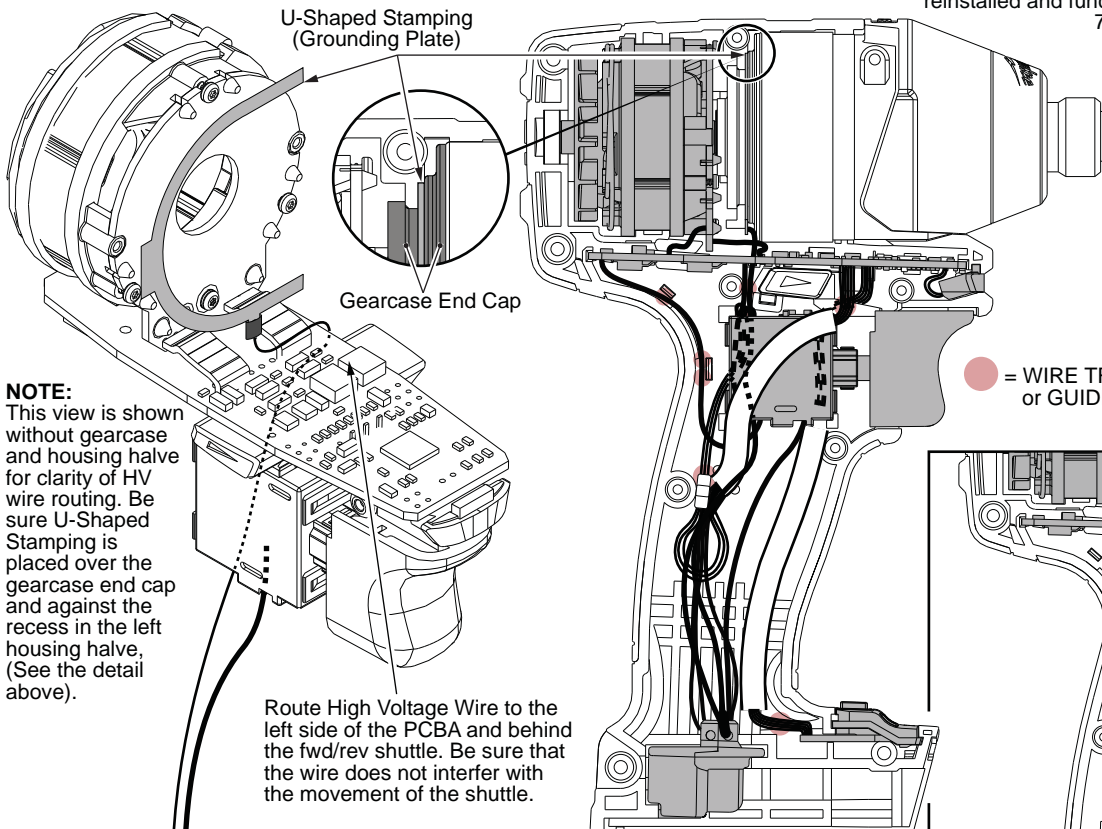

Solder the High Voltage Wire to negative terminal of battery connector block (along with black wire from switch). **Note:** Heat shrink tubing will have to be carefully trimmed away prior to soldering. After wire is soldered, wrap a thin piece of electrical tape around the two wires and terminal.

