



SERVICE PARTS LIST

BULLETIN NO.
54-24-2602

SPECIFY CATALOG NO. AND SERIAL NO. WHEN ORDERING PARTS		REVISED BULLETIN 54-24-2601	DATE Aug. 2014
M18 1/2" COMPACT HAMMER-DRILL			
CATALOG NO.	2602-20	STARTING SERIAL NO.	C15C
		WIRING INSTRUCTION SEE PAGE 3	

00 0

EXAMPLE:
Component Parts (Small #)
Are Included When Ordering
The Assembly (Large #).

#77 Two styles
of Brush Card
Assemblies
See Page Two

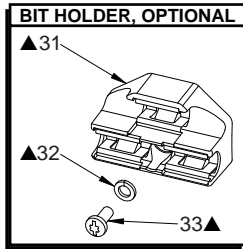
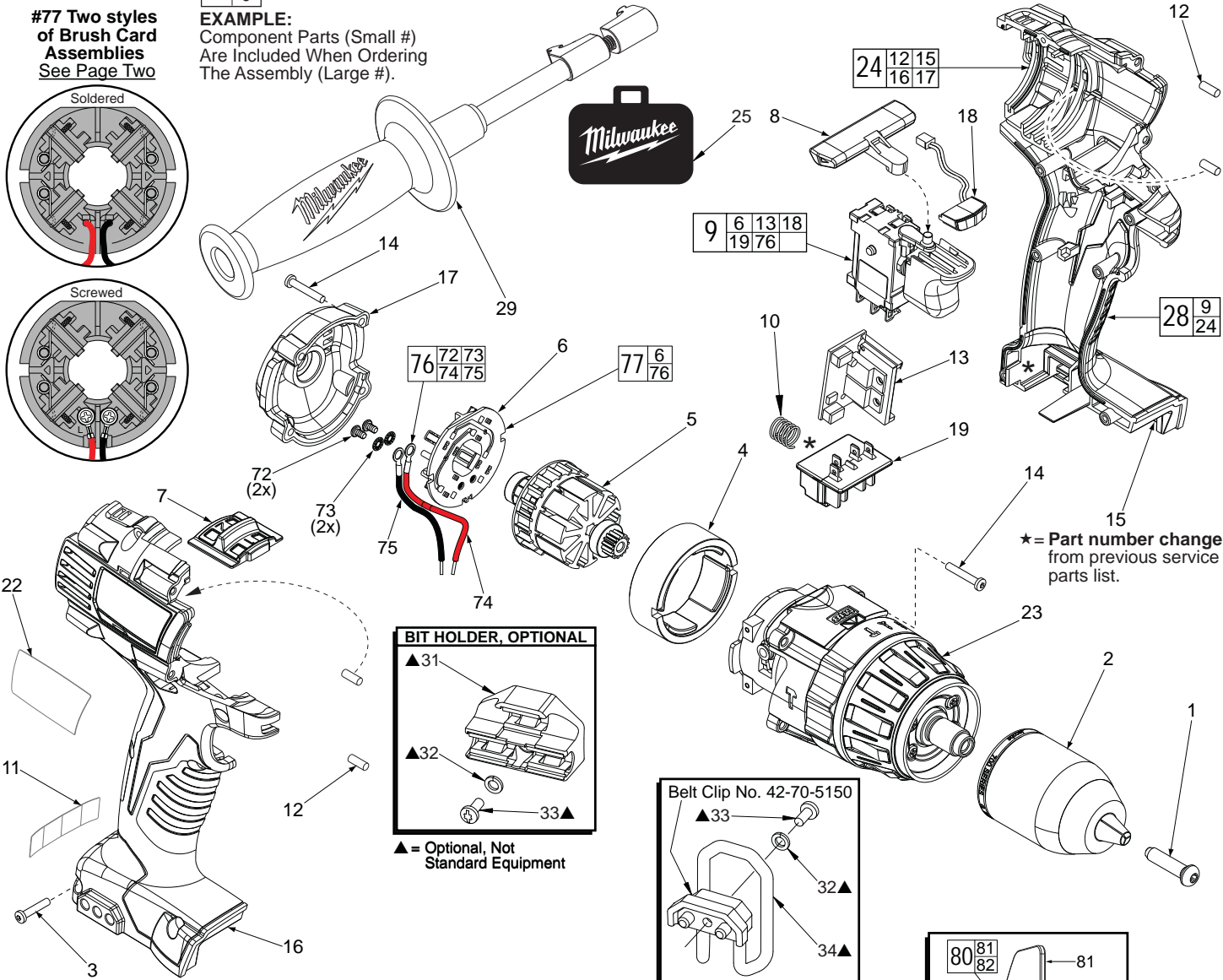
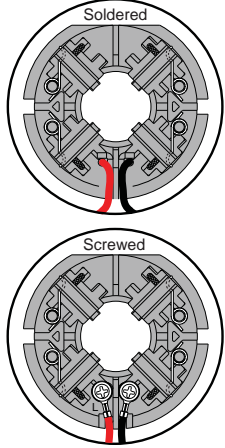

▲ = Optional, Not Standard Equipment

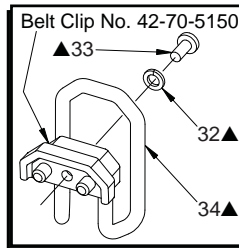

There are 2 belt clip designs for this tool. The initial design, Belt Clip #34, 42-70-5150 is being discontinued and replaced by Belt Clip Assembly #80, 42-70-2653.

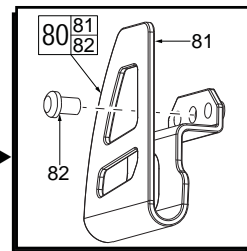
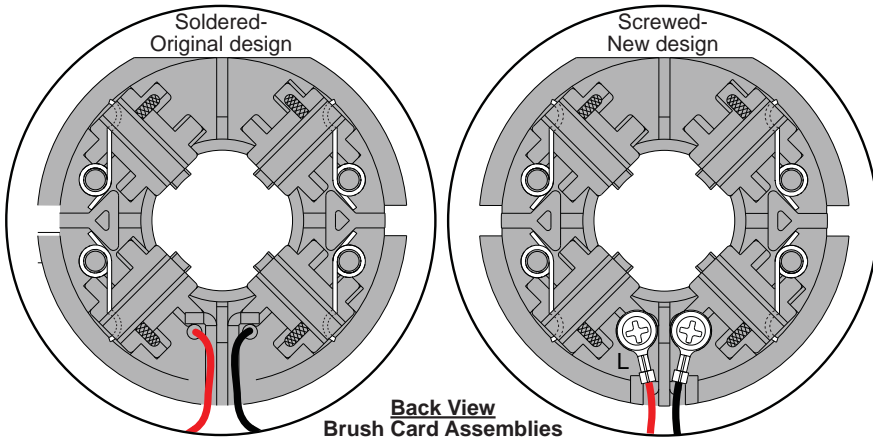

FIG.	PART NO.	DESCRIPTION OF PART	NO. REQ.
1	05-88-1500	M6 x 1.0 LH Chuck Screw w/ locking patch	(1)
2	42-66-0785	1/2" Keyless Chuck	(1)
3	06-82-6350	M3 x 16 Pan Hd. Plastite T-10 Screw	(7)
4	18-01-3016	Service Field	(1)
5	16-01-3015	Service Armature Assembly	(1)
6	-----	Brush Card	(1)
7	45-24-0250	High / Low Shifter	(1)
8	42-42-0850	Forward / Reverse Button	(1)
9	23-66-1236	Service Switch Assembly	(1)
10	40-50-1090	Compression Spring	(1)
11	10-20-2695	Warning Label	(1)
12	45-30-0270	Rubber Slug	(4)
13	-----	PCBA	(1)
14	05-88-0675	M3.0 x 20mm End Cap/Gearcase Scr T-10	(8)
15	-----	Left Handle	(1)
16	-----	Right Handle	(1)
17	42-50-1060	End Cap	(1)
18	-----	LED Assembly	(1)
19	-----	Terminal Block Assembly	(1)
22	12-20-2602	Service Nameplate Kit	(1)
★23	14-29-0376	Service Gearcase Assembly	(1)
24	31-44-2635	Service Housing Kit	(1)
★25	42-55-2603	Carrying Case, Optional	(1)
28	23-66-1237	Switch and Housing Kit	(1)
29	42-62-0526	Side Handle Assembly	(1)

FIG.	PART NO.	DESCRIPTION OF PART	NO. REQ.
31	43-72-0550	Bit Holder, <i>Optional</i>	(1)
32	45-88-1935	Washer, <i>Optional</i>	(1)
33	06-82-5275	6-32 x 5/16" Pan Hd. T-15 Screw, <i>Optional</i>	(2)
34	42-70-5150	Belt Hook, <i>Optional</i>	(1)
72	05-88-0928	M3 x 5mm Pan Hd. T10 Screw	(2)
73	45-88-1980	Spring Washer	(2)
74	-----	Leadwire Assembly - Red	(1)
75	-----	Leadwire Assembly - Black	(1)
76	14-46-2399	Leadwire/Screw/Washer Kit	(1)
77	14-46-2012	Brush Card Assembly	(1)
80	42-70-2653	Belt Clip Assembly	(1)
81	-----	Belt Clip	(1)
82	-----	Belt Clip Screw	(1)

MILWAUKEE ELECTRIC TOOL CORPORATION
13135 W. Lisbon Road, Brookfield, WI 53005
Drwg. 5



NOTE:
There are two Brush Card Assembly designs.

On the original brush card design the red and black wires that go to the switch are soldered on the brush card.

On the new brush card design the red and black wires that go to the switch are secured to the brush card with spring washers and screws.

The new brush card design is **directly interchangeable** in tools that have the old brush card design.

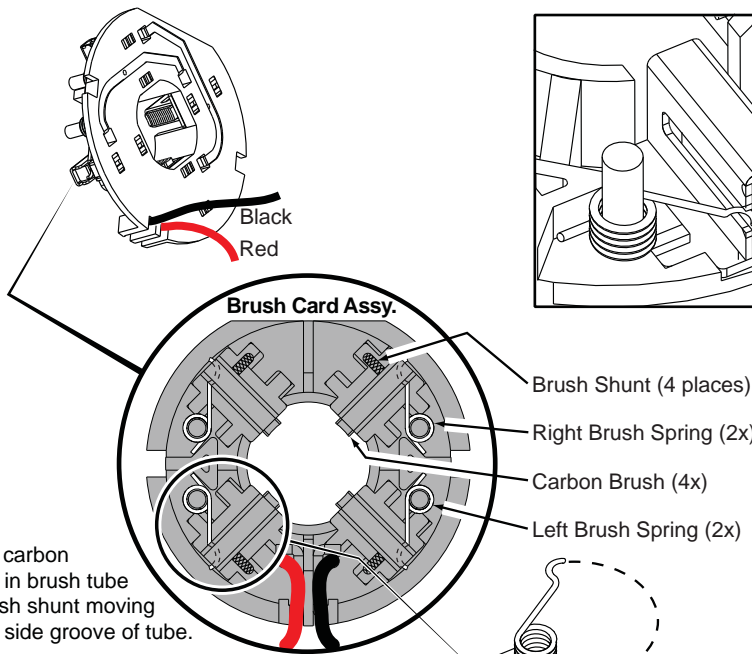

Be sure carbon brush is in brush tube with brush shunt moving freely in side groove of tube.

Place brush spring over post with short leg positioned downward as shown. Be sure spring is completely down with short leg trapped against 'Y' shaped wall on brush card.

While holding spring in place, bring the long leg of spring over the brush tube and through rear opening of tube. Position rounded hook of spring in groove on back of carbon brush. Be sure to check for free movement between carbon brush, brush shunt and brush spring.

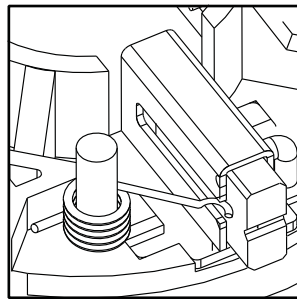

NOTE:
As an aid to prevent damage to the armature commutator or the brushes when removing and installing the armature assembly, it is recommended to pull the carbon brushes partially back into the brush tube. The carbon brushes will be held in place with the brush spring moving from the rear of the brush to the side of the brush.

In the unlikely event that the spring pops off follow the instructions below.

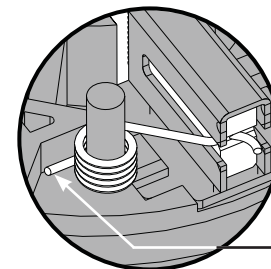
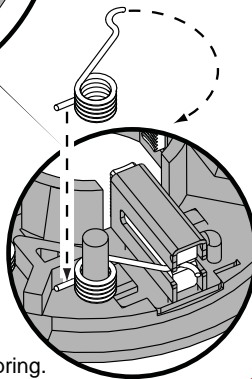

Correct

Short leg of spring to the bottom

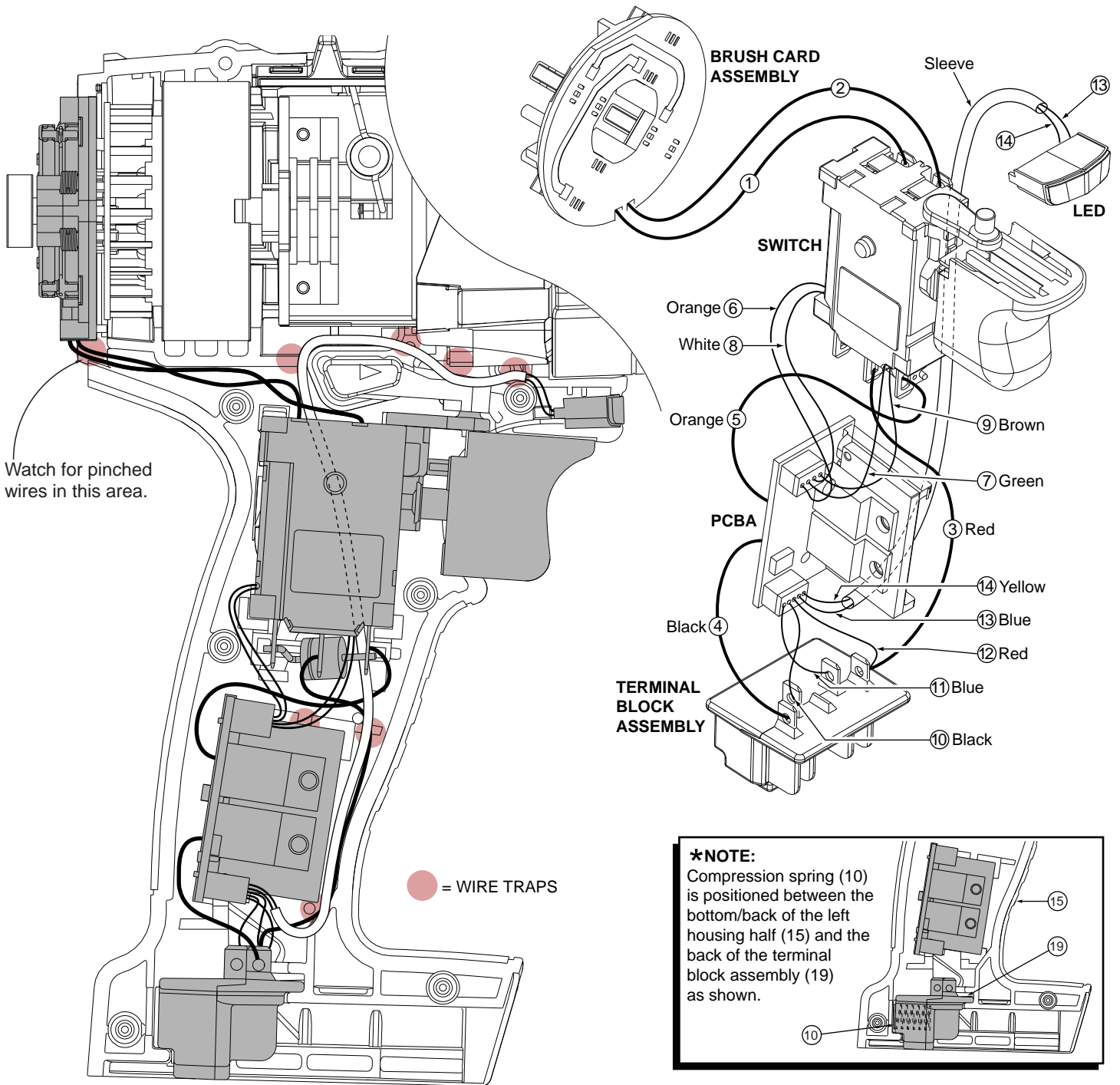

WIRING SPECIFICATIONS

Wire No.	Wire Color	Origin or Gauge	Length	Terminals, Connectors and 1 or 2 End Wire Preparation
1	Black	----	----	Component of Brush Card Assy. Connect to M2 on Switch.
2	Red	----	----	Component of Brush Card Assy. Connect to M1 on Switch.
3	Red	----	----	Component of Switch/Brush Card/Terminal Block Assembly.
4	Black	----	----	Component of Switch/Brush Card/Terminal Block Assembly.
5	Orange	----	----	Component of Switch/Brush Card/Terminal Block Assembly.
6	Orange	----	----	Component of Switch/Brush Card/Terminal Block Assembly.
7	Green	----	----	Component of Switch/Brush Card/Terminal Block Assembly.
8	White	----	----	Component of Switch/Brush Card/Terminal Block Assembly.
9	Brown	----	----	Component of Switch/Brush Card/Terminal Block Assembly.
10	Black	----	----	Component of Switch/Brush Card/Terminal Block Assembly.
11	Blue	----	----	Component of Switch/Brush Card/Terminal Block Assembly.
12	Red	----	----	Component of Switch/Brush Card/Terminal Block Assembly.
13	Blue	----	----	Component of Switch/Brush Card/Terminal Block Assy. (LED)
14	Yellow	----	----	Component of Switch/Brush Card/Terminal Block Assy. (LED)