

F 012 248 705

Stand } D3-05  
Issue } 04-10-06

**Fig./Abb. 1**

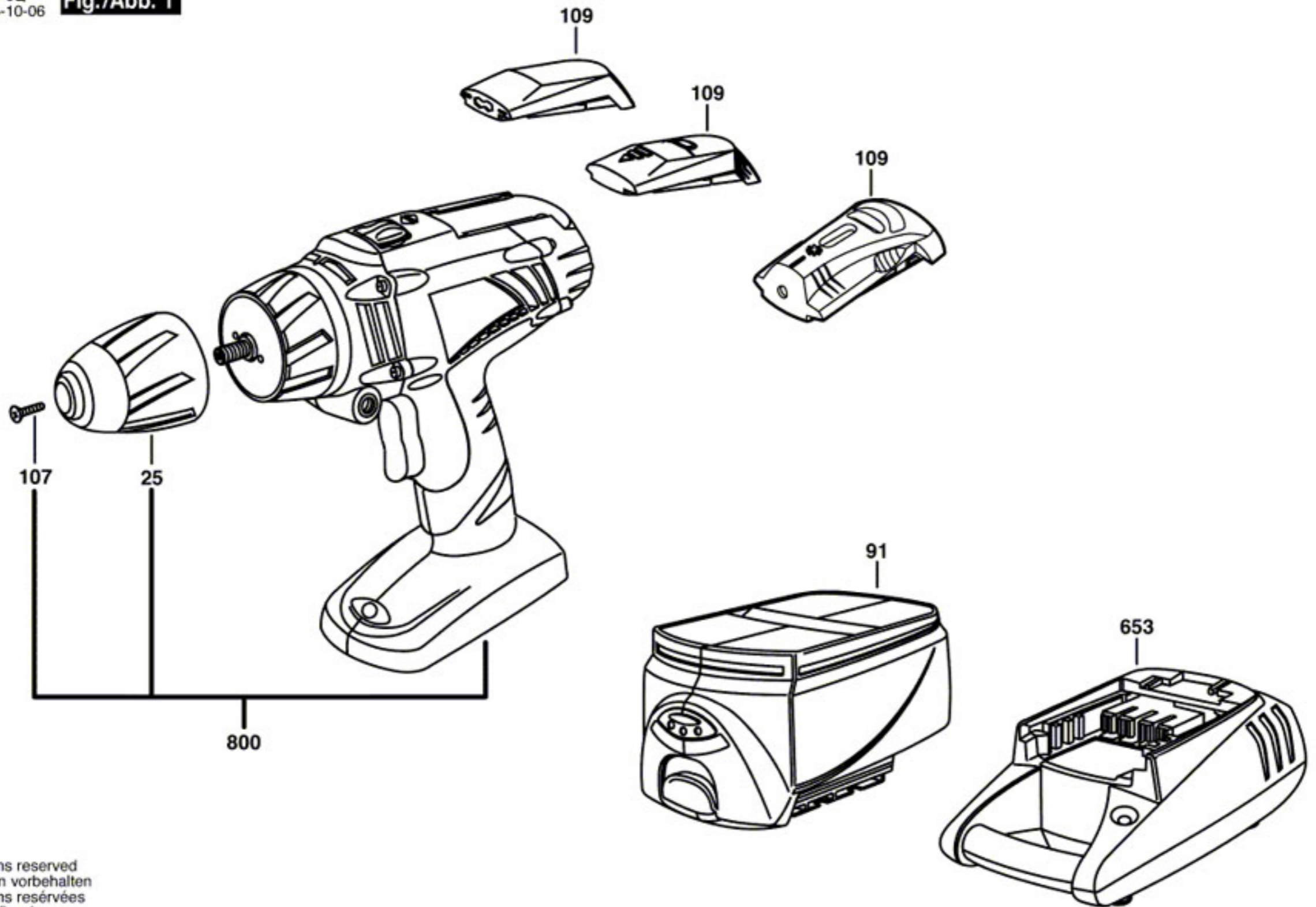

Modifications reserved  
Änderungen vorbehalten  
Modifications réservées  
Salvo modificaciones