



SERVICE PARTS LIST

BULLETIN NO.
54-07-0010

SPECIFY CATALOG NO. AND SERIAL NO. WHEN ORDERING PARTS		REVISED BULLETIN	DATE
M12™ THERMO IMAGER			Apr. 2013
CATALOG NO.	2260-20	SERIAL NUMBER	C87A
WIRING INSTRUCTION			

EXAMPLE:

00	0
----	---

 Component Parts (Small #) Are Included When Ordering The Assembly (Large #).

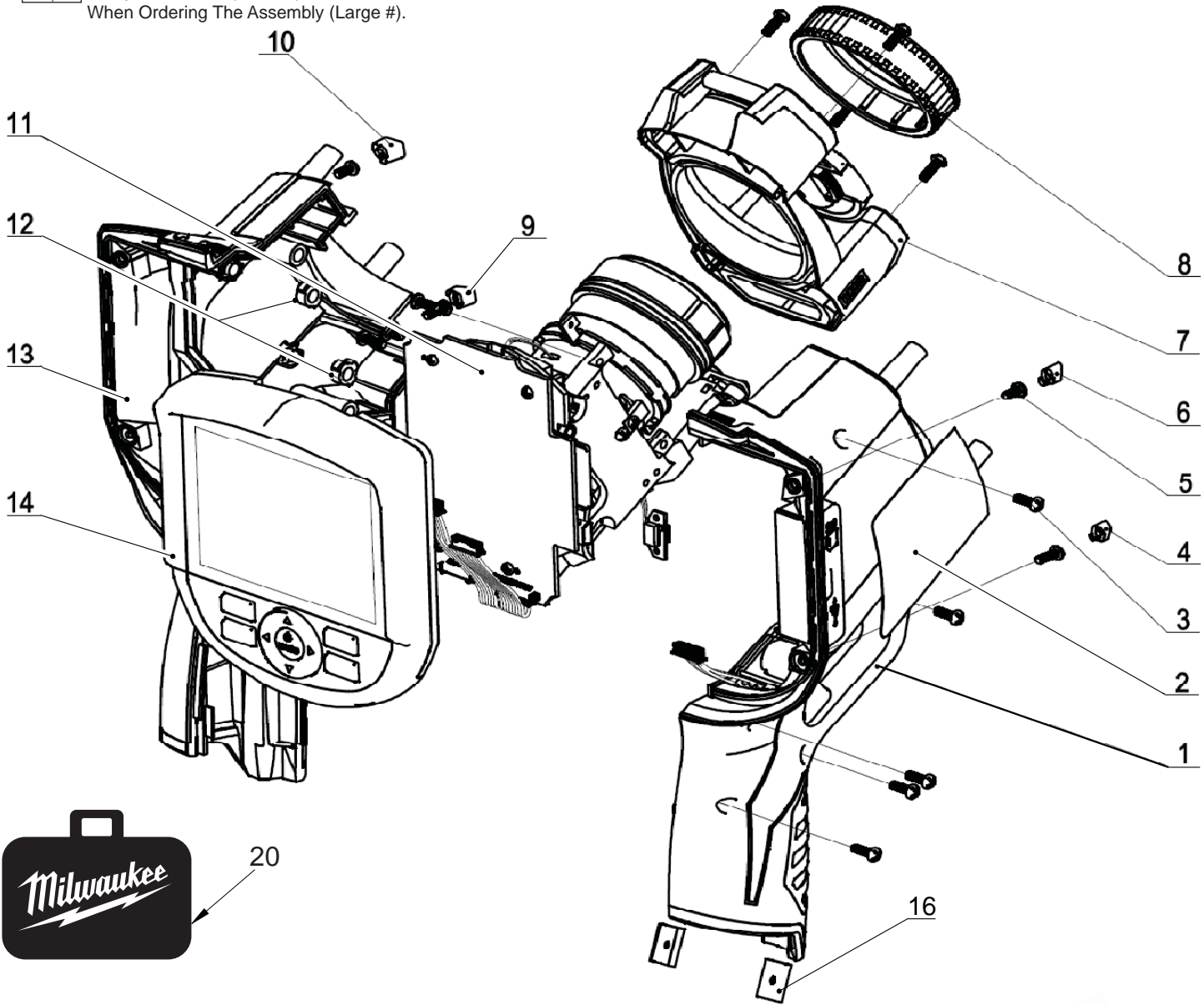

FIG.	PART NO.	DESCRIPTION OF PART	NO. REQ.
1	31-44-0890	Right Cover Assembly	(1)
2	-----	Nameplate	(1)
3	05-70-0075	M2.5 x 10 Flat Head Screw	(9)
4	05-81-0274	Screw Hole Plug - Lower Right	(1)
5	05-81-0272	M2.5 x 6 Countersunk Head Screw	(4)
6	05-81-0271	Screw Hole Plug - Upper Right	(1)
7	31-15-0230	Front Cover Assembly	(1)
8	42-76-0045	Focus Ring	(1)
9	05-81-0275	Screw Hole Plug - Lower Left	(1)
10	05-81-0273	Screw Hole Plug - Upper Left	(1)
11	44-06-0020	Optics and Electronics Assembly	(1)
12	42-38-0115	Rubber Buffer	(2)
13	31-44-0635	Left Cover Assembly	(1)
14	31-15-0235	Back Cover Assembly	(1)
16	42-70-0055	Housing Connectors	(2)
17	22-74-3005	2 GB SD Memory Card (Not Shown)	(1)
18	22-74-3010	SD Memory Card Reader with USB Plug	(1)
19	42-44-0205	Mini AB to Type A USB Cable	(1)
20	42-55-2265	Hard Carrying Case	(1)

