

Ref #	Part #	Description	Context Note	Foot Note
11	691907	Tube-Breather	Used After Code Date 95040200	
11A	691899	Tube-Breather	Used After Code Date 95010100	Used Before Code Date 95040300
11B	281426	Tube-Breather	Used Before Code Date 95010200	
81	691729	Lock-Muffler Screw		
161	498544	Base-Air Cleaner	(Metal)	
163	692277	Gasket-Air Cleaner		
298	690453	Locknut-Muffler/Elbow		
300	497141	Muffler	(Super Lo Tone)	
300A	692025	Muffler	(Round Lo Tone)	
300B	691951	Muffler	(Remote Lo Tone)	
346	690661	Screw	(Spark Arrestor)	
355	690310	Washer	(Muffler Bracket)	
425	691671	Screw	(Air Cleaner Cover)	
436	497140	Manifold-Exhaust		
437	695974	Screw	(Exhaust Manifold)	
445	691643	Filter-Air Cleaner Cartridge		
485	692295	Knob-Control	(Air Cleaner)	
613	691632	Screw	(Muffler)	
613A	691351	Screw	(Muffler)	
643	691926	Retainer-Air Filter		
676	393757	Deflector-Muffler		
676A	395700	Deflector-Muffler		
677	690661	Screw	(Muffler Deflector)	
740	691105	Nut	(Muffler Bracket)	
819A	690297	Screw	(Muffler Bracket)	
843A	691895	Sleeve-Lever	(Air Cleaner)	
883	692237	Gasket-Exhaust		
967	492889	Filter-Pre Cleaner		
968	691925	Cover-Air Cleaner		
971	691003	Screw	(Air Cleaner Base to Carburetor)	
994	399541	Arrestor-Spark		
1177	691105	Nut	(Muffler)	

DC ONLY	
SEE FLYWHEEL ASSEMBLY	
474	
877	
1059	
578A	

NOTE: ALL OLD STYLE STATORS USE REFERENCE NUMBER 1119 MOUNTING SCREW

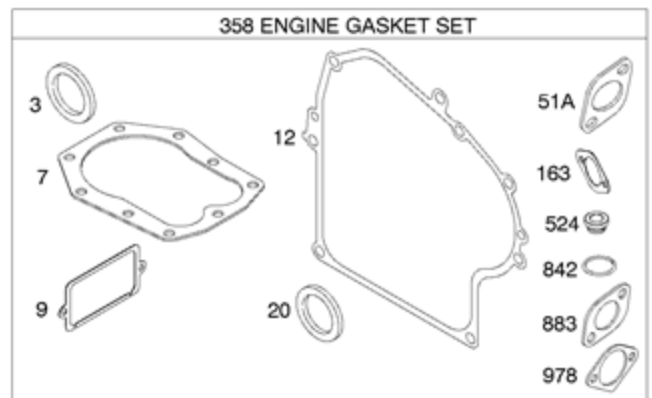
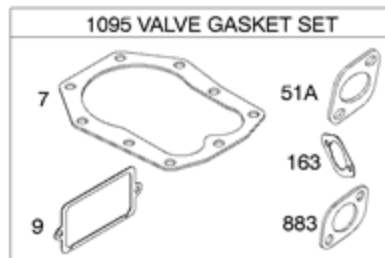
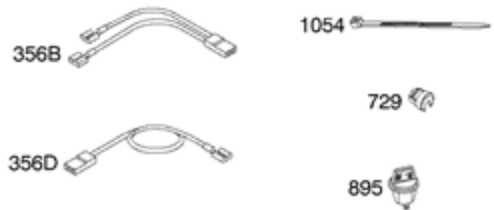

Ref #	Part #	Description	Context Note	Foot Note
3	391086S	Seal-Oil	(Magneto Side)	
7	272163S	Gasket-Cylinder Head		
9	27803S	Gasket-Breather		
12	27877	Gasket-Crankcase	(.009" Thick)	
12	27876	Gasket-Crankcase	(.005" Thick)	
12	692221	Gasket-Crankcase	(.015" Thick)	
20	391086S	Seal-Oil	(PTO Side)	
51A	691885	Gasket-Intake	(Manifold To Engine)	
163	692277	Gasket-Air Cleaner		
356B	398838	Wire-Stop		
358	497070	Gasket Set-Engine		
474	696578	Alternator	(DC Only)	
524	281370S	Seal-Dipstick Tube		
578A	692306	Wire Assembly	(Alternator)	
729	690603	Clip-Wire		
842	691870	Seal-O Ring	(Dipstick Tube)	
877	393814	Wire/Connector-Alternator	(DC Only)	
883	692237	Gasket-Exhaust		
895	692309	Switch-Rotary		
978	273326S	Gasket-Oil Gard		
1054	280275	Tie-Cable		
1059	698516	Kit-Screw/Washer		
1095	498534	Gasket Set-Valve		
1119	691183	Screw	(Alternator)	

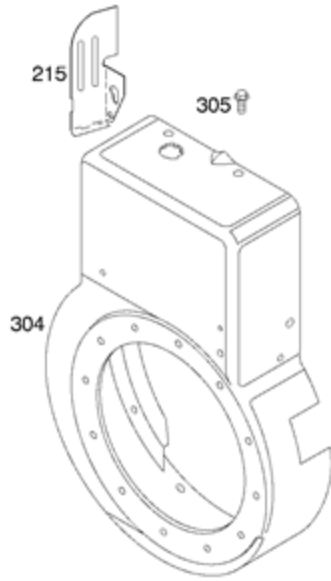

1036 EMISSION LABEL

1019 LABEL KIT

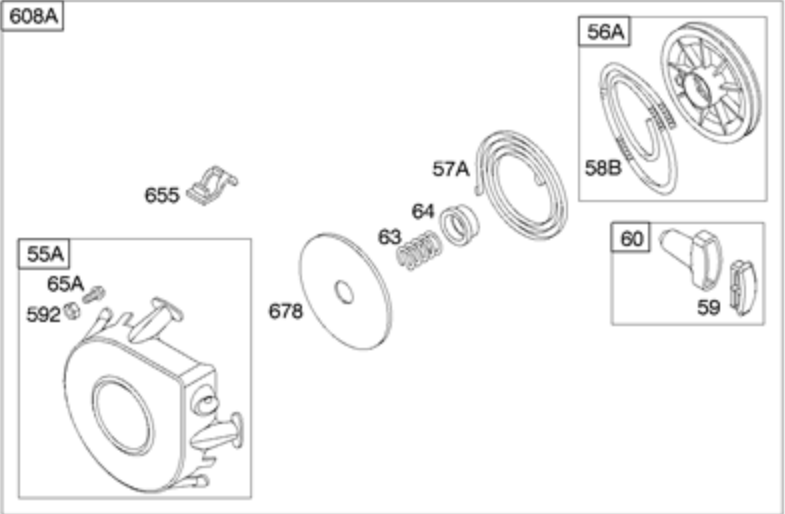
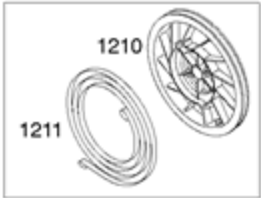
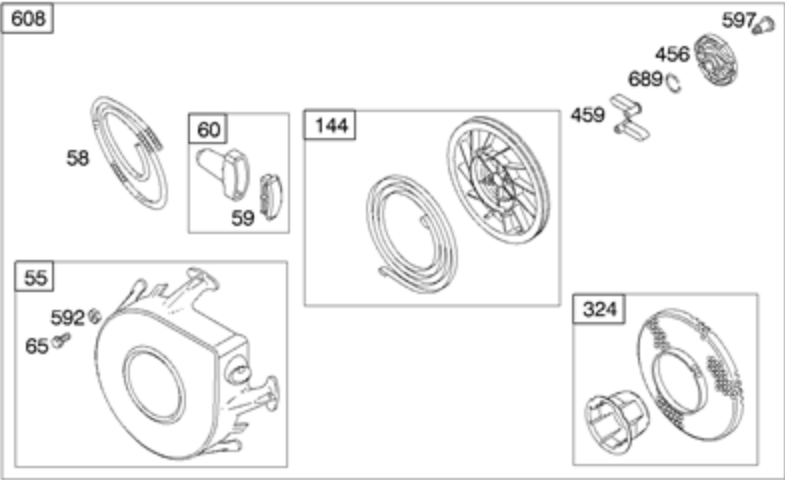
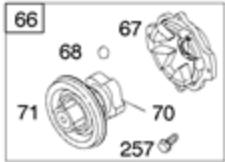

Ref #	Part #	Description	Context Note	Foot Note
37	690411	Guard-Flywheel		
55	693904	Housing-Rewind Starter	Used After Code Date 99022800	
55A	393576	Housing-Rewind Starter	Used Before Code Date 99030100	
56A	295871	Pulley-Starter	Used Before Code Date 99030100	
57A	490179	Spring-Rewind Starter	Used Before Code Date 99030100	
58	693389	Rope-Starter	(70" Long)	
58A	695002	Rope-Starter	(99" Long)(Cut to Required Length)	
58B	692188	Rope-Starter	(63" Long)	
59	490653	Insert-Grip		
60	490652	Grip-Starter Rope		
63	690547	Spring-Ratchet	Used Before Code Date 99030100	
64	691920	Adapter-Ratchet Spring	Used Before Code Date 99030100	
65	690759	Screw	(Rewind Starter) Used After Code Date 99022800	
65A	690837	Screw	(Rewind Starter) Used Before Code Date 99030100	
66	399671	Clutch-Starter	Used Before Code Date 99030100	
67	394897	Housing-Clutch	Used Before Code Date 99030100	
68	691604	Ball-Clutch	Used Before Code Date 99030100	
70	691945	Ratchet-Clutch	Used Before Code Date 99030100	
71	691359	Cover-Ratchet	Used Before Code Date 99030100	
78	690364	Screw	(Flywheel Guard)	
144	697843	Pulley/Spring Assembly		
215	691170	Guide-Air		
257	691660	Screw	(Starter Clutch) Used Before Code Date 99030100	
304	491596	Housing-Blower		
305	692198	Screw	(Blower Housing)	
324	695160	Screen/Cup Assembly		
456	692299	Plate-Pawl Friction	Used After Code Date 99022800	
459	281505S	Pawl-Ratchet	Used After Code Date 99022800	
592	690800	Nut	(Rewind Starter)	
597	691696	Screw	(Pawl Friction Plate) Used After Code Date 99022800	
608	693900	Starter-Rewind	(70" Long) Used After Code Date 99022800	
608A	390391	Starter-Rewind	(75" Long) Used Before Code Date 99030100	
655	691734	Anchor-Rewind Spring	Used Before Code Date 99030100	

Ref #	Part #	Description	Context Note	Foot Note
678	490817	Spacer-Rewind	Used Before Code Date 99030100	
689	691855	Spring-Friction	Used After Code Date 99022800	
727	395405	Cover-Starter Drive		
732	691097	Screw	(Starter Drive Cover)	
1019	491181	Kit-Label		
1036	694313	Label-Emissions	Used After Code Date 98123100	Used Before Code Date 99100100
1036	499353	Label-Emissions	Used Before Code Date 97052600	
1036	696768	Label-Emissions	Used After Code Date 01073000	
1036	695696	Label-Emissions	Used After Code Date 00063000	Used Before Code Date 01073100
1036	694988	Label-Emissions	Used After Code Date 98123100	Used Before Code Date 99100100
1036	499354	Label-Emissions	Used After Code Date 97052500	Used Before Code Date 99010100
1210	697843	Pulley/Spring Assembly	(Pulley) Used After Code Date 00082000	Used Before Code Date 01051100
1211	697843	Pulley/Spring Assembly	(Spring) Used After Code Date 00082000	Used Before Code Date 01051100

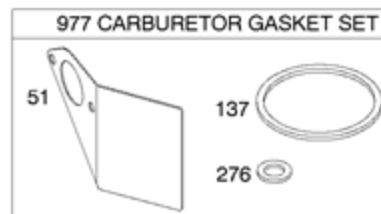
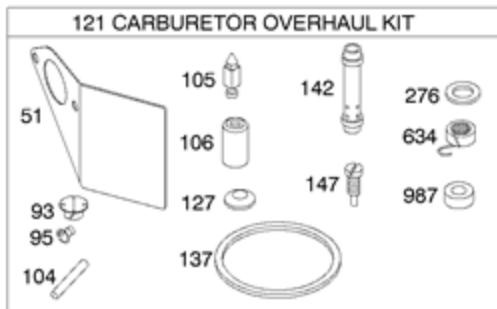
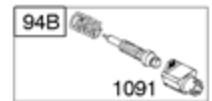
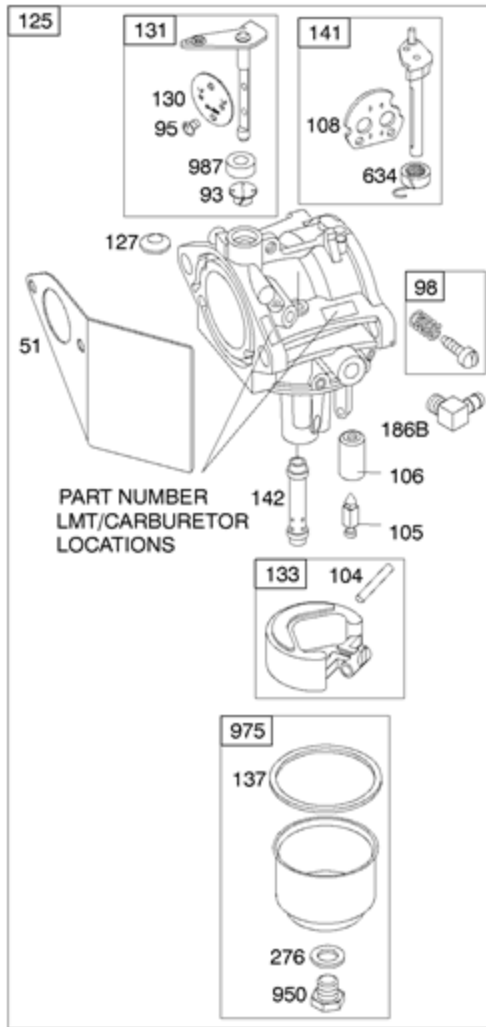
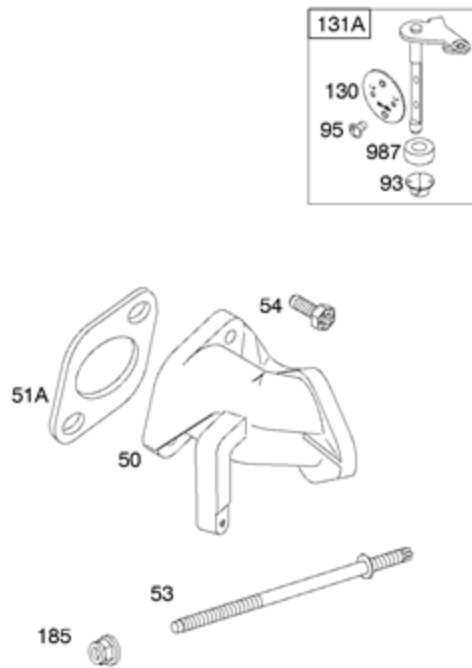

Ref #	Part #	Description	Context Note	Foot Note
50	691157	Manifold-Intake		
51	691886	Gasket-Intake	(Manifold To Carburetor)	
51A	691885	Gasket-Intake	(Manifold To Engine)	
53	691672	Stud	(Carburetor)	
54	93208	Screw	(Intake Manifold)	
93	690602	Bushing-Throttle Shaft		
94	494383	Kit-Idle Mixture	(LMT 102, 113, 114, 116)	
94	496589	Kit-Idle Mixture	(LMT 172)	
94B	498836	Kit-Idle Mixture	(LMT 141)	
95	691636	Screw	(Throttle Valve)	
98	495800	Kit-Idle Speed	(Carburetor)	
104	690525	Pin-Float Hinge		
105	691782	Valve-Float Needle		
106	691780	Seat-Inlet		
108	690467	Valve-Choke		
121	497849	Kit-Carburetor Overhaul	Used After Code Date 94062300	
121	497166	Kit-Carburetor Overhaul	Used Before Code Date 94062400	
125	690111	Carburetor	(LMT 203) Used After Code Date 97081000	
127	694524	Plug-Welch		
130	691750	Valve-Throttle		
131	497846	Kit-Throttle Shaft		
131A	497159	Kit-Throttle Shaft	Used Before Code Date 94090100	
133	494381	Float-Carburetor		
137	281165S	Gasket-Float Bowl		
141	497160	Kit-Choke Shaft		
142	690125	Nozzle-Carburetor	(Standard) (LMT 203)	
142	691477	Nozzle-Carburetor	(Standard) (LMT 172)	
142	497196	Nozzle-Carburetor	(Standard) (LMT 69, 103)	
142	497198	Nozzle-Carburetor	(Standard) (LMT 102)	
142	497564	Nozzle-Carburetor	(Standard) (LMT 113, 114, 116)	
142	498716	Nozzle-Carburetor	(Standard) (LMT 141)	
143	499032	Nozzle-Carburetor	(High Altitude) (LMT 141, 172)	
143	690126	Nozzle-Carburetor	(High Altitude) (LMT 203)	
143	497198	Nozzle-Carburetor	(High Altitude) (LMT 102)	
143	497848	Nozzle-Carburetor	(High Altitude) (LMT 113, 114, 116)	
147	497472	Jet-Pilot	(LMT 102, 113, 114, 116)	
185	690958	Nut	(Air Cleaner Base)	
186B	692317	Connector-Hose	(Carburetor)	
276	692255	Washer-Sealing		

Ref #	Part #	Description	Context Note	Foot Note
634	690802	Spring/Seal Assembly		
950	691657	Screw-Float Bowl		
975	495933	Bowl-Float		
977	497069	Gasket Set-Carburetor		
987	691326	Seal-Throttle Shaft		
1091	691333	Cap-Limiter		

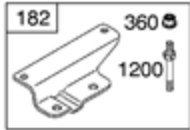
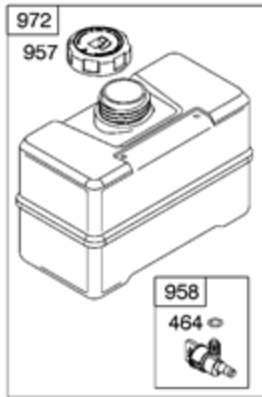

674A

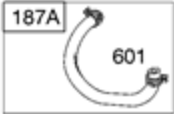
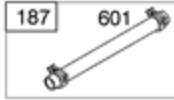
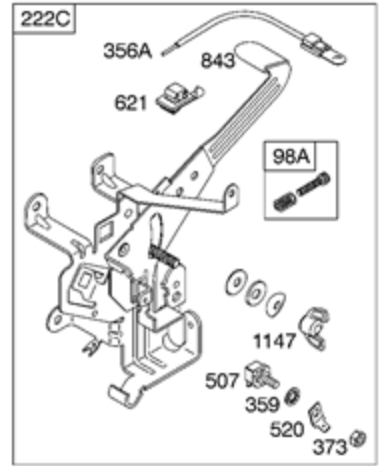

188

240

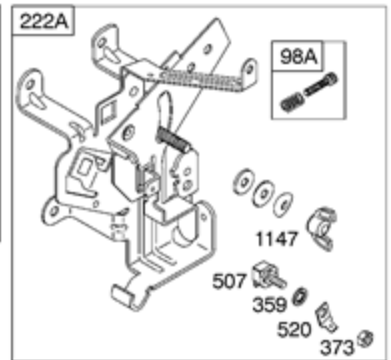
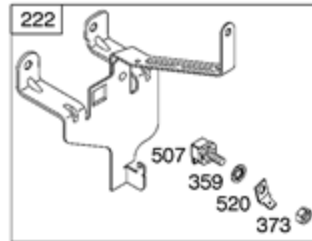

188

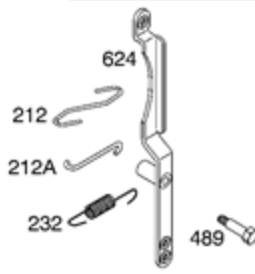
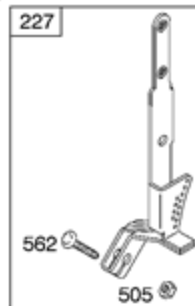
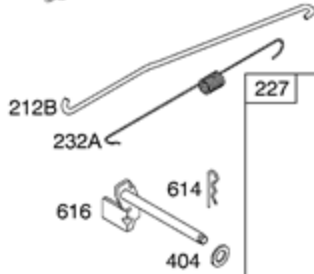

Ref #	Part #	Description	Context Note	Foot Note
98A	493280	Kit-Idle Speed	(Control Bracket)	
182	495664	Bracket-Fuel Tank		
182C	695451	Bracket-Fuel Tank		
182D	694592	Bracket-Fuel Tank		
187	296004	Line-Fuel	(Cut To Required Length)	
187A	497029	Line-Fuel	(Molded)	
188	691693	Screw	(Control Bracket)	
209	692136	Spring-Governor	(Yellow)	
209A	260723	Spring-Governor	Used Before Code Date 94090100	
212	691853	Link-Throttle	(Linkage Lever To Throttle Shaft)	
212A	691854	Link-Throttle	(Governor Control Lever To Linkage Lever)	
212B	262970	Link-Throttle	(Governor Control Lever To Linkage Lever)	
222	694182	Bracket-Control	Used After Code Date 98120600	
227	692143	Lever-Governor Control		
227A	496253	Lever-Governor Control		
232	691848	Spring-Governor Link		
232A	691846	Spring-Governor Link		
240	394358S	Filter-Fuel	(White)	
265	691024	Clamp-Casing		
267	690804	Screw	(Casing Clamp)	
268	691025	Casing-Control Wire	(Cut To Required Length)	
269	691026	Wire-Control	(Cut To Required Length)	
270	691027	Nut	(Control Wire Casing)	
271	691028	Lever-Control		
356A	691408	Wire-Stop		
359	691077	Washer	(Ground Terminal)	
360	691105	Nut	(Fuel Tank Bracket)	
373	691612	Nut	(Ground Terminal)	
385	691673	Screw	(Fuel Pump)	
387	692026	Pump-Fuel		
404	691691	Washer	(Governor Crank)	
453	691131	Screw	(Electromagnetic Bracket)	
464	691898	Seal-O Ring	(Fuel Shut-off Valve)	
489	691776	Screw	(Linkage Lever)	
505	691251	Nut	(Governor Control Lever)	
507	691972	Insulator		
520	691084	Terminal-Ground		
562	691119	Bolt	(Governor Control Lever)	
601	95162S	Clamp-Hose		

Ref #	Part #	Description	Context Note	Foot Note
614	691620	Pin-Cotter		
616	691405	Crank-Governor		
621	692310	Switch-Stop		
624	691415	Lever-Linkage		
674	691058	Screw	(Fuel Tank Bracket)	
674A	690708	Screw	(Fuel Tank Bracket)	
843	691322	Sleeve-Lever	(Control Bracket)	
918	497457	Hose-Vacuum		
957	493988S	Cap-Fuel Tank	(Plastic)	
958	399517	Valve-Fuel Shut Off	(Plastic)	
972	691993	Tank-Fuel	(Plastic) (4 Quart)	
1042	691229	Bracket-Electromagnetic		
1147	690355	Nut	(Control Bracket)	
1200	691690	Stud	(Fuel Tank Bracket)	

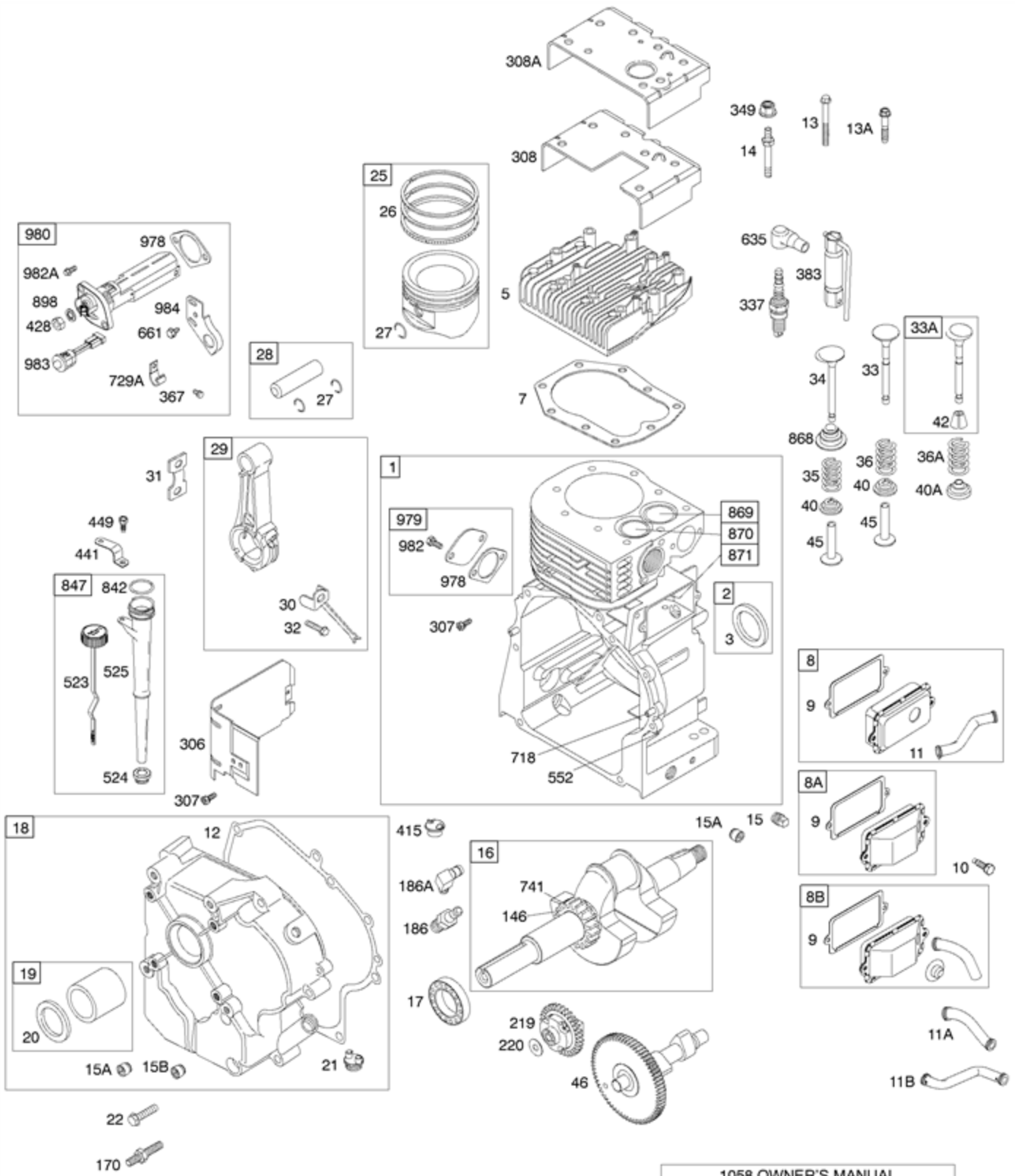

Ref #	Part #	Description	Context Note	Foot Note
1	495631	Cylinder Assembly		
2	698340	Kit-Bushing/Seal	(Magneto Side)	
3	391086S	Seal-Oil	(Magneto Side)	
5	691159	Head-Cylinder		
7	272163S	Gasket-Cylinder Head		
8	498038	Breather Assembly	Used After Code Date 95040200	
8A	495736	Breather Assembly	Used After Code Date 95010100 Used Before Code Date 95040300	
8B	497710	Breather Assembly	Used Before Code Date 95010200	
9	27803S	Gasket-Breather		
10	691666	Screw	(Breather Assembly)	
11	691907	Tube-Breather	Used After Code Date 95040200	
11A	691899	Tube-Breather	Used After Code Date 95010100 Used Before Code Date 95040300	
11B	281426	Tube-Breather	Used Before Code Date 95010200	
12	27877	Gasket-Crankcase	(.009" Thick)	
12	692221	Gasket-Crankcase	(.015" Thick)	
12	27876	Gasket-Crankcase	(.005" Thick)	
13	691651	Screw	(Cylinder Head) (3 9/16" Long)	
13A	690904	Screw	(Cylinder Head) (3" Long)	
14	691690	Stud	(Cylinder Head) (3 1/4" Long)	
15	690946	Plug-Oil Drain	(Square Head)	
15A	691680	Plug-Oil Drain	(3/8" Square Socket)	
16	495790	Crankshaft	Used After Code Date 95041600	
17	691069	Bearing-Ball		
18	496984	Cover-Crankcase		
19	295964	Kit-Bushing/Seal	(PTO Side)	
20	391086S	Seal-Oil	(PTO Side)	
21	281658S	Cap-Oil Fill		
22	693972	Screw	(Crankcase Cover/Sump)	
25	499907	Piston Assembly	(Standard)	
25	499909	Piston Assembly	(.020" Oversize)	
26	299743	Ring Set-STD	(Standard)(Chrome)	
26	499921	Ring Set-STD	(Standard)	
26	690019	Ring Set-STD	(.020" Oversize)	
26	690020	Ring Set-STD	(.030" Oversize)	
27	690975	Lock-Piston Pin		
28	499302	Pin-Piston	(Standard)	
28	499303	Pin-Piston	(.005" Oversize)	

Ref #	Part #	Description	Context Note	Foot Note
29	390401	Rod-Connecting	(Standard)	
29	390773	Rod-Connecting	(.020" Undersize)	
30	691728	Dipper-Connecting Rod		
31	222114	Lock-Rod Screw		
32	690352	Screw	(Connecting Rod)	
33	691287	Valve-Exhaust	Used After Code Date 95041600	
33A	691794	Valve-Exhaust	Used Before Code Date 95041700	
34	261055S	Valve-Intake		
35	691605	Spring-Valve	(Intake)	
36	691605	Spring-Valve	(Exhaust) Used After Code Date 95041600	
36A	691597	Spring-Valve	(Exhaust) Used Before Code Date 95041700	
40	690656	Retainer-Valve		
40A	691939	Retainer-Valve	Used Before Code Date 95041700	
42	494553	Keeper-Valve	Used Before Code Date 95041700	
45	691793	Tappet-Valve		
46	691167	Camshaft		
146	690979	Key-Timing		
170	691695	Stud	(Crankcase Cover/Sump)	
186	691764	Connector-Hose		
186A	691609	Connector-Hose		
219	496786	Gear-Governor		
220	691724	Washer	(Governor Gear)	
306	496797	Shield-Cylinder		
307	691003	Screw	(Cylinder Shield)	
308A	691201	Cover-Cylinder Head		
337	496018S	Plug-Spark		
349	691105	Nut	(Cylinder Head Cover)	
367	691058	Screw	(Wire Clip)	
383	89838S	Wrench-Spark Plug		
428	691612	Nut	(Oil GARD Kit)	
441	690501	Bracket-Oil Fill		
449	691130	Screw	(Oil Fill Bracket)	
523	691386	Dipstick		
524	281370S	Seal-Dipstick Tube		
525	691389	Tube-Dipstick		
552	491986	Bushing-Governor Crank		
635	66538S	Boot-Spark Plug		

Ref #	Part #	Description	Context Note	Foot Note
661	690661	Screw	(Oil Gard Light Bracket)	
718	690959	Pin-Locating		
729A	690430	Clip-Wire	(Oil GARD Kit)	
741	691288	Gear-Timing		
842	691870	Seal-O Ring	(Dipstick Tube)	
847	399901	Dipstick/Tube Assembly		
868	692036	Seal-Valve		
869	691844	Seat-Valve	(Intake)	
870	691844	Seat-Valve	(Exhaust)	
871	231218	Bushing-Valve Guide	(Intake)	
871	261961	Bushing-Valve Guide	(Exhaust)	
898	691077	Washer	(Oil GARD Kit)	
978	273326S	Gasket-Oil Gard		
979	691382	Cover-OIL GARD		
980	398182	Kit-Oil Gard		
982	690351	Screw	(Oil GARD) (Oil GARD Cover)	
982A	690350	Screw	(Oil GARD) (Oil GARD Kit)	
983	398660	Light-Indicator		
984	692340	Bracket-Oil Gard Light		
1058	274786	Operator's Manual		

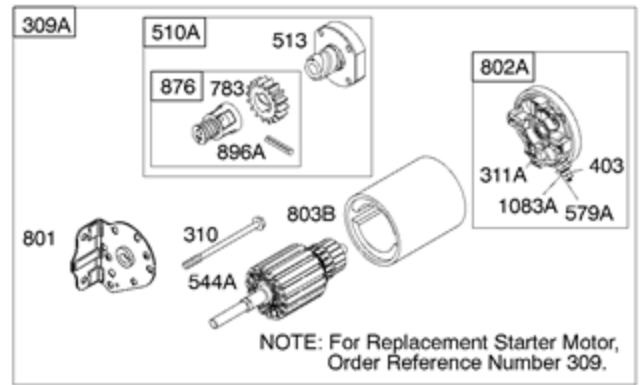
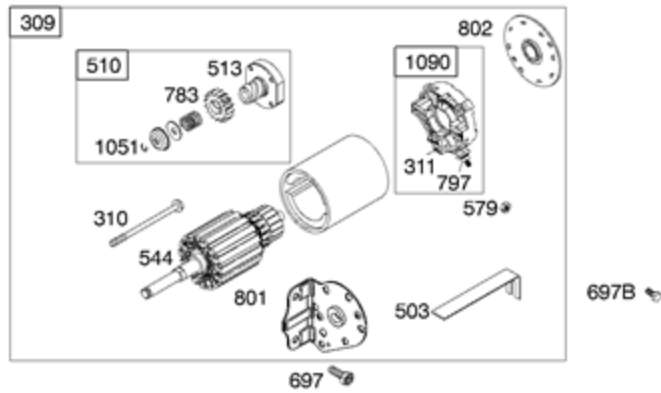
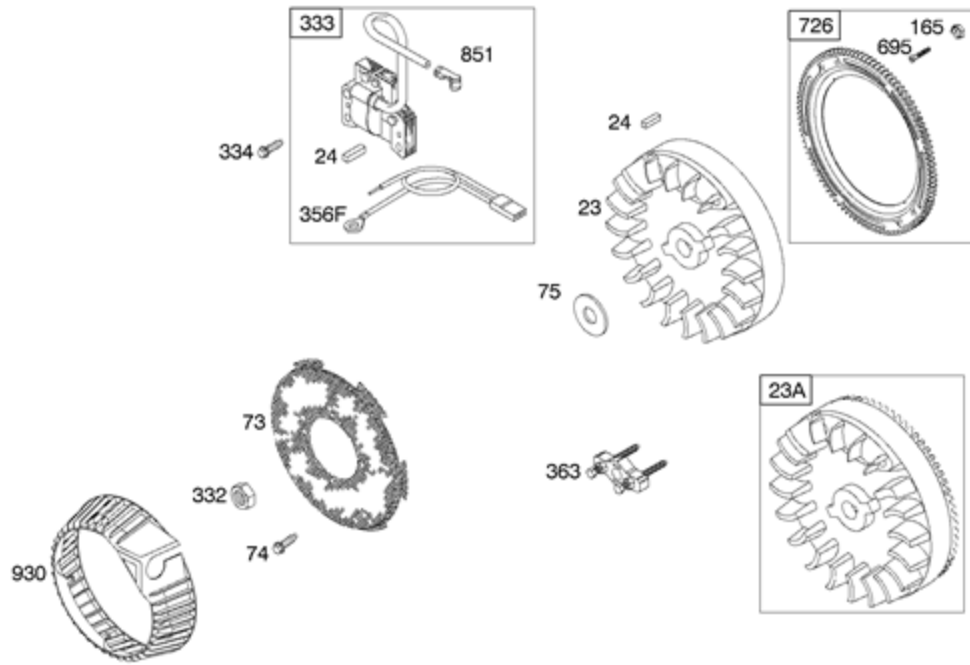

Ref #	Part #	Description	Context Note	Foot Note
23	690615	Flywheel	(Rewind Start)	
23A	XXXXXX	Flywheel	(Electric Start)	
24	222698S	Key-Flywheel		
73	691754	Screen-Rotating	Used Before Code Date 99030100	
74	691627	Screw	(Rotating Screen)	
75	690582	Washer	(Flywheel)	
165	693148	Nut	(Ring Gear)	
309	693054	Motor-Starter		
309A		Motor-Starter	(For Replacement Starter Motor, Order Reference 309)	
310	690323	Screw	(Starter Motor)	
311	497608	Brush Set		
311A	395538	Brush Set	(3 5/8" Housing Length)	
332	693899	Nut	(Flywheel) Used After Code Date 99022800	
333	398811	Armature-Magneto		
334	691061	Screw	(Magneto Armature)	
356F	398808	Wire-Stop	(Magneto Armature)	
363	19203	Puller-Flywheel		
403	690288	Washer	(End Cap)	
503	691532	Strap-Starter		
510	696541	Drive-Starter		
510A	696540	Drive-Starter		
513	692024	Clutch-Drive		
544	692034	Armature-Starter		
544A	390837	Armature-Starter	(3 5/8" Housing Length)	
579	691029	Nut	(Starter Cable)	
579A	691626	Nut	(Starter Cable)	
695	693109	Screw	(Ring Gear)	
697	690372	Screw	(Drive Cap)	
697B	691058	Screw	(Drive Cap)	
726	696537	Gear-Ring	(Includes Mounting Hardware)	
783	695708	Gear-Pinion		
797	693167	Nut	(Brush Retainer)	
801	691283	Cap-Drive		
802	691286	Cap-End		
802A	395537	Cap-End	(3 5/8" Housing Length)	
803B	398159	Housing-Starter	(3 5/8" Housing Length)	
851	493880S	Terminal-Spark Plug		

Ref #	Part #	Description	Context Note	Foot Note
876	696539	Kit-Pinion Spring		
896A	691641	Pin-Drive Retainer		
1051	691265	Ring-Retaining		
1083A	690958	Nut	(End Cap)	
1090	691293	Retainer-Brush		