

3 601 H31 210
 Stand } 08-04
 Issue } 09-06-29

Fig./Abb. 1

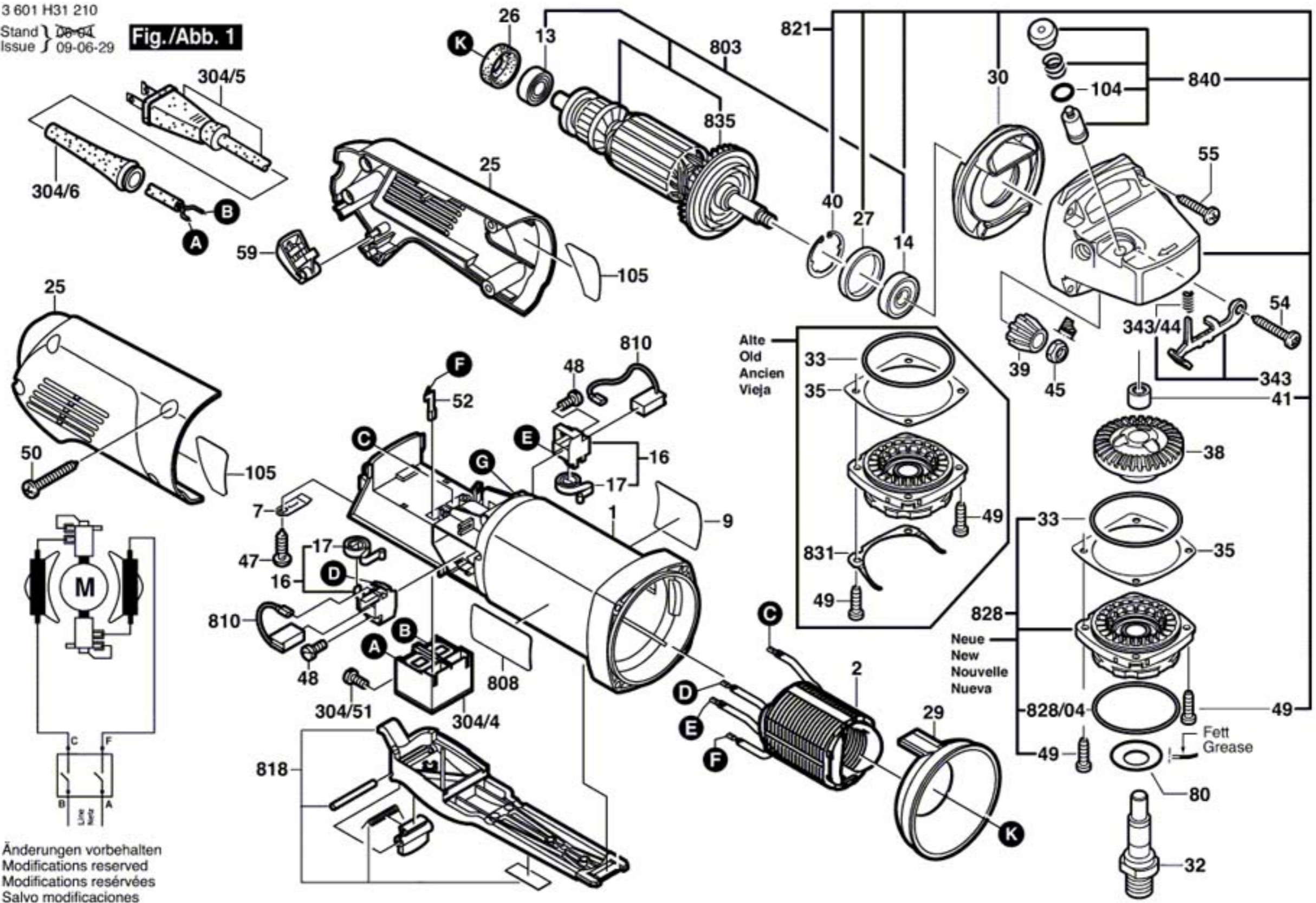

Änderungen vorbehalten
 Modifications reserved
 Modifications réservées
 Salvo modificaciones

