

0 601 587 651  
 Issue | 07-05  
 Stand | 08-02-06

**Fig./Abb. 1**

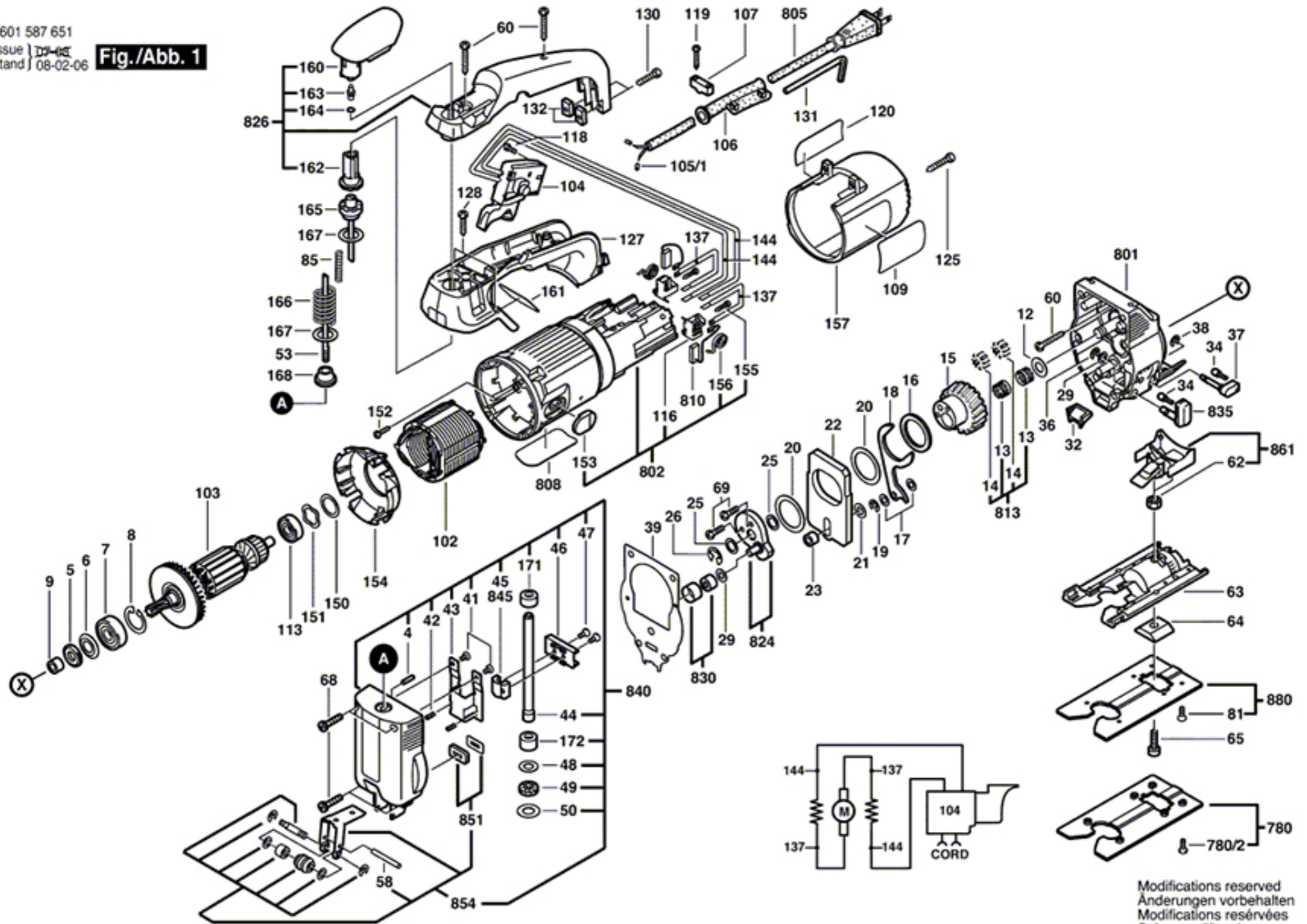

Modifications reserved  
 Änderungen vorbehalten  
 Modifications réservées  
 Salvo modificaciones