

STABILIZER CONTROL

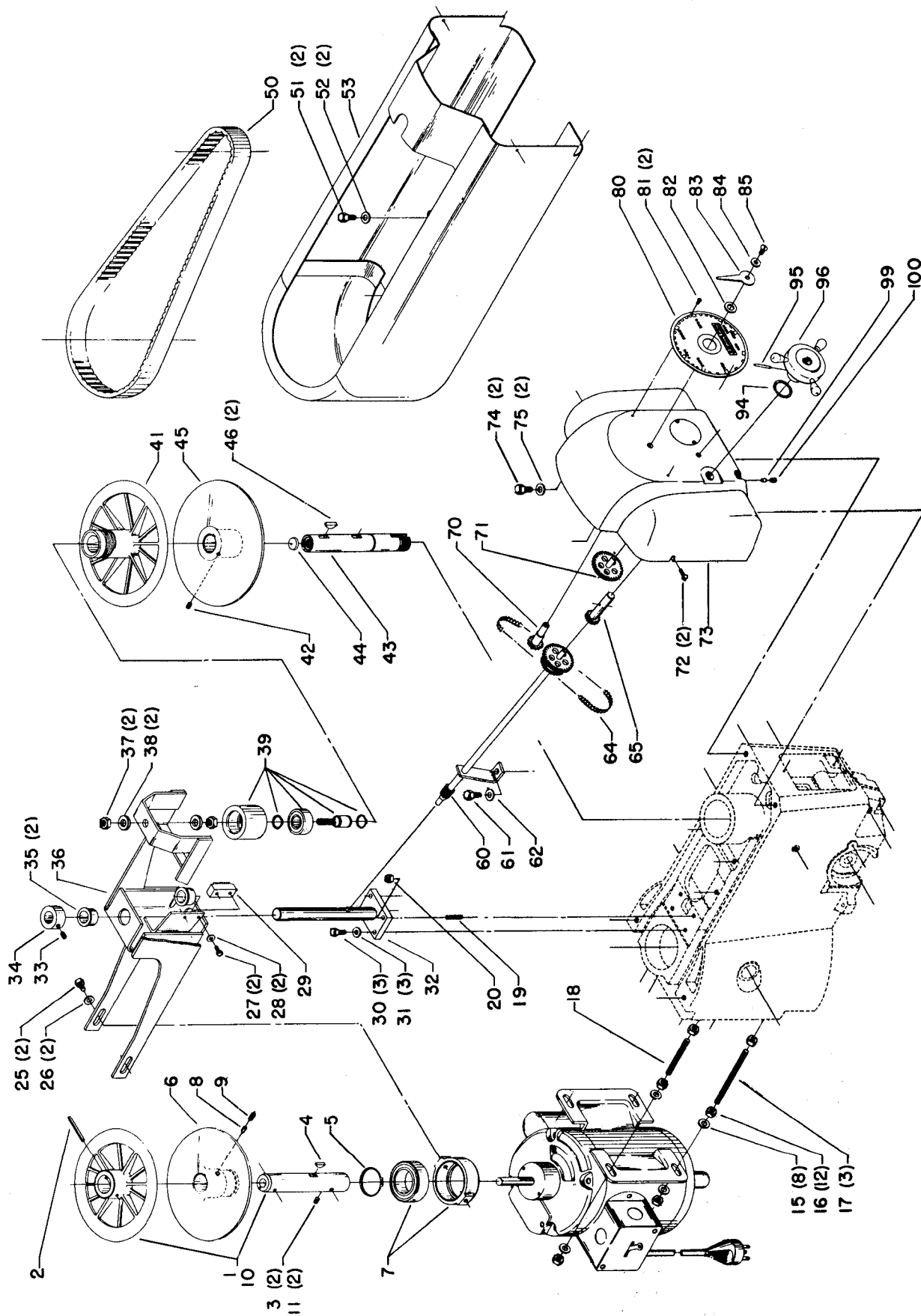



Parts List for 15-309 Type 1

| Item Number | Part Number | Description | Qty Required |
|-------------|---------------|---------------------|--------------|
| 1 | 000000-00 | No Longer Available | 1 |
| 2 | 000000-00 | No Longer Available | 1 |
| 3 | 491950-00 | SET SCREW | 2 |
| 4 | 000000-00 | No Longer Available | 1 |
| 5 | 000000-00 | No Longer Available | 1 |
| 6 | 000000-00 | No Longer Available | 1 |
| 7 | 000000-00 | No Longer Available | 1 |
| 8 | 000000-00 | No Longer Available | 1 |
| 9 | 901041909415 | HD SET SCR | 1 |
| 10 | 000000-00 | No Longer Available | 1 |
| 11 | 901041506227 | SET SCREW | 2 |
| 15 | 904010101620S | WASHER | 8 |
| 16 | 902010205435S | JAM NUT | 12 |
| 17 | 000000-00 | No Longer Available | 1 |
| 18 | 000000-00 | No Longer Available | 1 |
| 19 | 901041500296 | SET SCREW | 1 |
| 20 | 489026-00 | HEX NUT | 1 |
| 25 | 901020100514 | MACHINE SCREW | 2 |
| 26 | 904010101614S | STEEL WASHER | 2 |
| 27 | 000000-00 | No Longer Available | 1 |
| 28 | 904010101619 | STEEL WASHER | 2 |
| 29 | 000000-00 | No Longer Available | 1 |
| 30 | 901010600611S | CAP SCREW | 3 |
| 31 | 904010101614S | STEEL WASHER | 3 |
| 32 | 000000-00 | No Longer Available | 1 |
| 33 | 491950-00 | SET SCREW | 1 |
| 34 | 000000-00 | No Longer Available | 1 |

Parts List for 15-309 Type 1

| Item Number | Part Number | Description | Qty Required |
|-------------|---------------|---------------------|--------------|
| 35 | 000000-00 | No Longer Available | 1 |
| 36 | 000000-00 | No Longer Available | 1 |
| 37 | 489191-00 | HEX NUT | 2 |
| 38 | 491956-00 | WASHER | 2 |
| 39 | 000000-00 | No Longer Available | 1 |
| 41 | 000000-00 | No Longer Available | 1 |
| 42 | 491950-00 | SET SCREW | 1 |
| 43 | 000000-00 | No Longer Available | 1 |
| 44 | 000000-00 | No Longer Available | 1 |
| 45 | 000000-00 | No Longer Available | 1 |
| 46 | 000000-00 | No Longer Available | 1 |
| 50 | 000000-00 | No Longer Available | 1 |
| 51 | 901010600605 | CAP SCREW | 2 |
| 52 | 904010101620S | WASHER | 2 |
| 53 | 000000-00 | No Longer Available | 1 |
| 60 | 000000-00 | No Longer Available | 1 |
| 61 | 901010600605 | CAP SCREW | 1 |
| 62 | 904010101620S | WASHER | 1 |
| 64 | 000000-00 | No Longer Available | 1 |
| 65 | 000000-00 | No Longer Available | 1 |
| 70 | 000000-00 | No Longer Available | 1 |
| 71 | 000000-00 | No Longer Available | 1 |
| 72 | 000000-00 | No Longer Available | 2 |
| 73 | 000000-00 | No Longer Available | 1 |
| 74 | 901010600605 | CAP SCREW | 2 |
| 75 | 904010101620S | WASHER | 2 |
| 80 | 000000-00 | No Longer Available | 1 |

Parts List for 15-309 Type 1

| Item Number | Part Number | Description | Qty Required |
|-------------|---------------|---------------------|--------------|
| 81 | 901061317359 | SELF TAP SCREW | 2 |
| 82 | 000000-00 | No Longer Available | 1 |
| 83 | 000000-00 | No Longer Available | 1 |
| 84 | 904010101614S | STEEL WASHER | 1 |
| 85 | 901020100514 | MACHINE SCREW | 1 |
| 94 | 000000-00 | No Longer Available | 1 |
| 95 | 000000-00 | No Longer Available | 1 |
| 96 | 000000-00 | No Longer Available | 1 |
| 99 | 000000-00 | No Longer Available | 1 |
| 100 | 491950-00 | SET SCREW | 1 |
| 110 | 000000-00 | No Longer Available | 1 |
| 111 | 000000-00 | No Longer Available | 1 |
| 112 | 000000-00 | No Longer Available | 1 |
| 113 | 000000-00 | No Longer Available | 1 |
| 114 | 000000-00 | No Longer Available | 1 |
| 120 | 000000-00 | No Longer Available | 1 |
| 121 | 000000-00 | No Longer Available | 1 |
| 122 | 901010600618 | CAP SCREW | 1 |
| 123 | 000000-00 | No Longer Available | 1 |
| 124 | 402040725002 | SCALE | 1 |
| 125 | 901061317359 | SELF TAP SCREW | 2 |
| 126 | 931049913461 | CLAMP NUT | 1 |
| 127 | 904100313893 | WASHER | 1 |
| 128 | 000000-00 | No Longer Available | 1 |
| 129 | 000000-00 | No Longer Available | 1 |
| 130 | 904010101636S | WASHER | 1 |
| 131 | 000000-00 | No Longer Available | 1 |

Parts List for 15-309 Type 1

| Item Number | Part Number | Description | Qty Required |
|-------------|---------------|---------------------|--------------|
| 132 | 000000-00 | No Longer Available | 1 |
| 135 | 000000-00 | No Longer Available | 2 |
| 136 | 000000-00 | No Longer Available | 1 |
| 140 | 000000-00 | No Longer Available | 1 |
| 141 | 000000-00 | No Longer Available | 1 |
| 145 | 000000-00 | No Longer Available | 1 |
| 146 | 901041501112 | SET SCREW | 2 |
| 160 | 000000-00 | No Longer Available | 1 |
| 161 | 402030275002 | CLAMP | 1 |
| 162 | 000000-00 | No Longer Available | 1 |
| 163 | 904010312905S | FLAT WASHER | 1 |
| 164 | 000000-00 | No Longer Available | 1 |
| 165 | 406030330001S | HANDLE | 1 |
| 166 | 901021207528 | MACHINE SCREW | 1 |
| 167 | 000000-00 | No Longer Available | 1 |
| 168 | 402043315002 | PINION RET SPRING | 1 |
| 169 | 000000-00 | No Longer Available | 1 |
| 170 | 000000-00 | No Longer Available | 1 |
| 171 | 000000-00 | No Longer Available | 1 |
| 172 | 000000-00 | No Longer Available | 1 |
| 173 | 000000-00 | No Longer Available | 1 |
| 174 | 000000-00 | No Longer Available | 1 |
| 175 | 000000-00 | No Longer Available | 1 |
| 176 | 901061317359 | SELF TAP SCREW | 1 |
| 177 | 000000-00 | No Longer Available | 1 |
| 178 | 000000-00 | No Longer Available | 1 |
| 179 | 402041125001 | ADJUSTING SCREW | 1 |

Parts List for 15-309 Type 1

| Item Number | Part Number | Description | Qty Required |
|-------------|---------------|----------------------|--------------|
| 180 | 902012009706 | HEX NUT | 1 |
| 190 | 000000-00 | No Longer Available | 1 |
| 191 | 920040205383 | BEARING | 1 |
| 192 | 000000-00 | No Longer Available | 1 |
| 193 | 000000-00 | No Longer Available | 1 |
| 194 | 928060107352 | SPRING WASHER | 1 |
| 195 | 920040205383 | BEARING | 1 |
| 196 | 000000-00 | No Longer Available | 1 |
| 197 | 000000-00 | No Longer Available | 1 |
| 198 | 402031055001 | SLEEVE | 1 |
| 199 | 901010600621 | CAP SCREW | 1 |
| 200 | 902010205435S | JAM NUT | 1 |
| 201 | 901040100378 | SET SCREW | 1 |
| 202 | 1641138 | KNOB | 2 |
| 203 | 000000-00 | No Longer Available | 1 |
| 204 | 000000-00 | No Longer Available | 1 |
| 205 | 921010100028 | STEEL BALL | 1 |
| 206 | 000000-00 | No Longer Available | 1 |
| 207 | 000000-00 | No Longer Available | 1 |
| 208 | 000000-00 | No Longer Available | 1 |
| 209 | 000000-00 | No Longer Available | 1 |
| 210 | 902010101232 | HEX NUT | 1 |
| 211 | 901030131026S | CAP SCREW | 1 |
| 212 | 000000-00 | No Longer Available | 1 |
| 213 | 000000-00 | No Longer Available | 1 |
| 214 | 402040310001S | SWITCH OPENING COVER | 1 |
| 215 | 901061317359 | SELF TAP SCREW | 2 |

Parts List for 15-309 Type 1

| Item Number | Part Number | Description | Qty Required |
|-------------|---------------|---------------------|--------------|
| 220 | 904150107411 | RING | 1 |
| 221 | 920040205384 | BEARING | 1 |
| 222 | 000000-00 | No Longer Available | 1 |
| 223 | 402090770002 | QUILL | 1 |
| 224 | 908000003769 | GASKET | 1 |
| 225 | 402043145007 | STOP COLLAR ASSY | 1 |
| 226 | 901040900112 | SET SCREW | 1 |
| 227 | 901010600622S | CAP SCREW | 1 |
| 228 | 402040885005 | MICRO STOP | 1 |
| 229 | 901042601534 | THUMB SCREW | 1 |
| 230 | 402040885005 | MICRO STOP | 1 |
| 231 | 000000-00 | No Longer Available | 1 |
| 232 | 931021414087 | CLAMP NUT | 1 |
| 233 | 489191-00 | HEX NUT | 1 |
| 234 | 904150107410 | RING | 1 |
| 235 | 920040205384 | BEARING | 1 |
| 236 | 902070207176S | BEARING CLOSURE NUT | 1 |
| 237 | 000000-00 | No Longer Available | 1 |
| 238 | 5140043-11 | 0-1/2 IN 3JAW CHUK | 1 |
| 239 | 000000-00 | No Longer Available | 1 |
| 856 | 000000-00 | No Longer Available | 1 |
| 856 | 000000-00 | No Longer Available | 1 |