

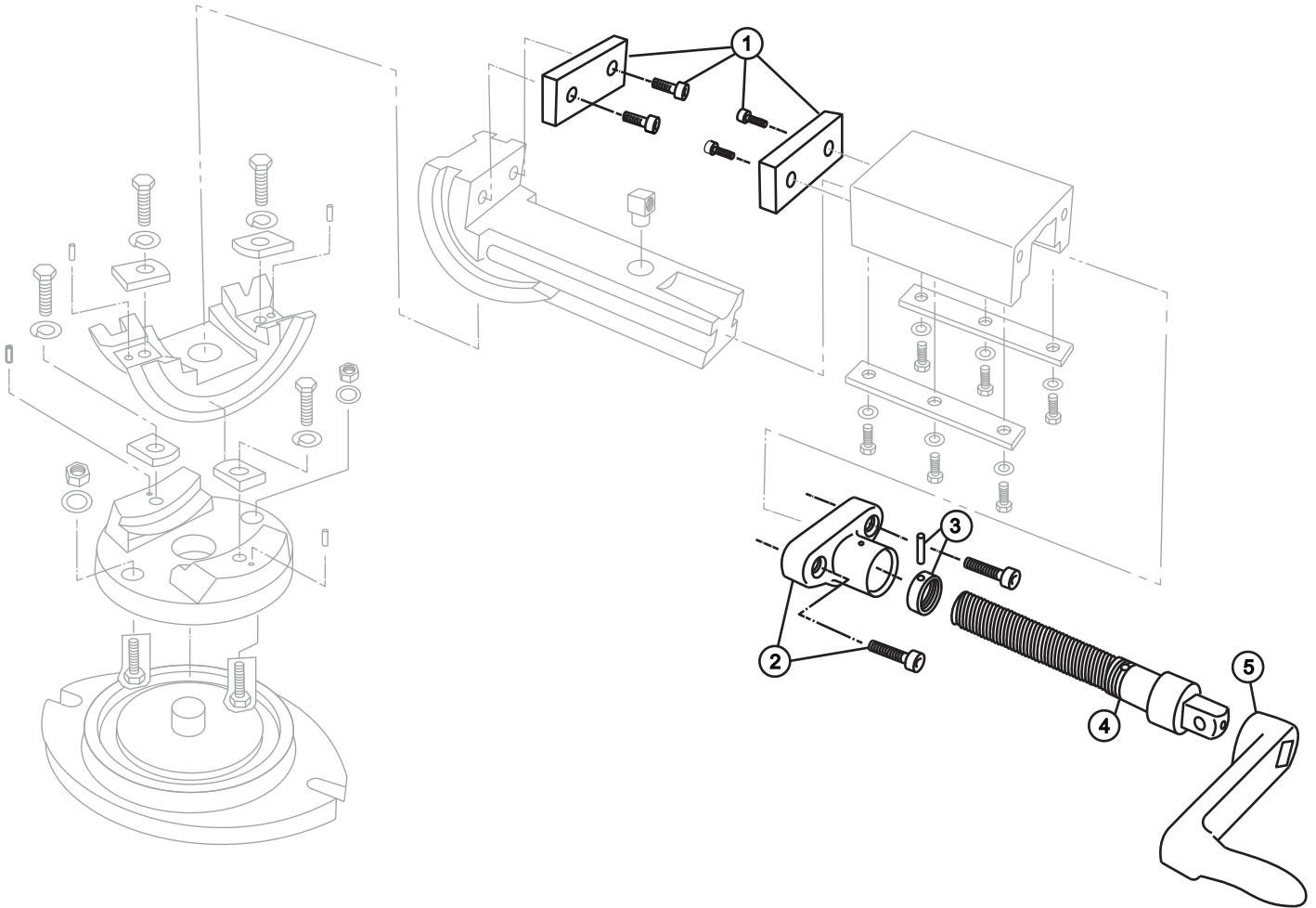

**Super Precision 3-Axis Tilting Machine Vise Parts Diagram**

2" Jaw Width, 2" Jaw Opening, 1-5/16" Jaw Depth

Stock #: 11700 Model #: TLT/SP-50



#	Part	Description
1	11700-01	Jaw Insert Assembly
2	11700-02	Sleeve and Socket Head (2)
3	11700-03	Collar and Roll Pin
4	11700-04	Clamp Screw
5	11700-05	Handle