



BOSCH

Rotary Hammer

----- | 0 611 201 840

Table of Content

Spare parts list.....	2
Illustration - Type.....	5

Spare parts list

Item	Part Number	Description
23	1 615 806 017	Gear Housing
24	1 612 317 003	Guide Rail
26	1 618 700 033	Hammer Piston
27	1 618 710 030	Striker
30	1 610 322 004	Spacer Bushing
31	1 610 120 018	Conical Spring Washer
33	1 618 598 037	Bit holder
34	1 610 224 001	Retaining snap ring
40	1 615 500 194	Sealing cap
41	1 615 133 019	Handle
42	2 100 102 016	Carrying Case Ø32xØ25x0,3 MM
43	1 617 200 017	On-Off Switch
47	1 614 461 025	Power supply cord
48	3 600 703 011	Grommet Ø9,2-Ø12x120 MM
49	1 601 302 013	Fastening Clamp
50	1 901 091 013	Socket-Terminal Strip 3x6 MM
54	1 610 501 031	Sealing cap
56	1 600 210 010	O-Ring 35,0x1,5 MM
59	1 610 210 015	O-Ring 28,0x6,0 MM
61	1 602 381 001	Insulating Strip 33x10x6 MM
65	2 916 601 014	Retaining ring 26 DIN 9045
68	1 611 015 015	Sealing Plate 1,5 MM
74	2 910 021 116	Socket head cap screw DIN 84-AM4x6-8.8
80	1 613 414 005	Hex Socket Head Cap Screw M5x20 MM
80	3 603 414 028	Hex Socket Head Cap Screw
82	2 910 151 164	Hex Socket Head Cap Screw M5x25 DIN 912-10.9
84	1 617 000 121	Hex Socket Head Cap Screw
85	2 910 211 007	Tapping Screw DIN 7971-BZ2,9x16
87	2 910 211 011	Tapping Screw DIN 7971-BZ3,5x13
88	2 910 211 021	Tapping Screw DIN 7971-ST3,9x22-F
99	1 614 437 007	Connecting Cable L=230 MM
103	2 910 141 199	Hex Socket Head Cap Screw DIN 912-M6x18-8.8
104	2 916 603 012	Retaining ring 22 DIN 9045
807	1 617 000 014	Locking Bolt Set

Spare parts list

Item	Part Number	Description
1	1 615 102 052	Motor Housing
2	1 614 220 041	Pole Shoe 115V
3	1 610 205 000	Seal Ring
4	1 610 910 052	Needle-Roller Bearing
5	1 614 011 025	Armature 120V
6	1 615 805 045	Flanged Bearing
7	1 610 905 000	groove ball bearing
8	1 611 038 015	Intermediate Plate
9	1 616 610 044	Fan
10	1 615 500 123	Housing Cover
12	1 614 652 000	Spiral Spring
13	3 615 500 502	Sealing cap
16	1 615 820 045	Bearing Housing
17	1 610 910 044	Needle bearing
19	1 610 910 048	Needle bearing
20	1 616 110 013	Eccentric Shaft Z=46
21	1 616 317 013	Cylindrical Gear Z=18
22	1 610 300 043	Bushing
45	1 610 913 000	Thrust Needle Rim
46	1 610 101 008	Thrust Bearing Disc 1,0 MM THICK
53	1 611 110 194	Manufacturer's nameplate
57	1 600 102 623	Plain Washer 1,0 MM THICK
58	1 600 150 006	Spring Washer DIN 137-A4
62	2 916 660 011	Spring retaining ring DIN 472-28x1,2 MM
64	2 917 721 034	Round-Head Grooved Pin 2x6 DIN 1476-ST
66	1 611 015 006	Sealing Plate
67	1 611 015 007	Sealing Plate
70	2 915 061 005	Hex Nut DIN 985-M8-8
75	2 910 021 120	Socket head cap screw DIN 84-AM4x10-8.8
77	2 910 021 176	Dummy DIN 84-BM5x55-8.8
79	2 910 110 118	Pan head screw DIN 85-AM4x8-MS
83	1 617 000 120	Parts Set 2 PIECE
86	2 910 601 118	Tapping Screw DIN 7972-B3,9x13
89	1 616 309 007	Cylindrical Gear Z=43
91	1 610 320 008	Clutch Element

Spare parts list

Item	Part Number	Description
94	1 903 230 009	Ball DIN 5401-5 G28
95	1 610 320 009	Clutch Element
102	1 611 331 007	Tab Washer
808	1 617 014 110	Carbon-Brush Set
660	1 618 598 038	Bit holder
800	1 617 000 022	Parts Set
801	1 616 309 009	Cylindrical Gear Z=43/8
802	1 617 000 018	Wear and Tear Part Set
806	1 618 597 902	Toolholder
820	1 617 031 000	Modification Set

Illustration - Type - E

EW - EVW 2 / 302 / 4 X (12.76)

Typ 0 611 201 ...
0 611 202 ...

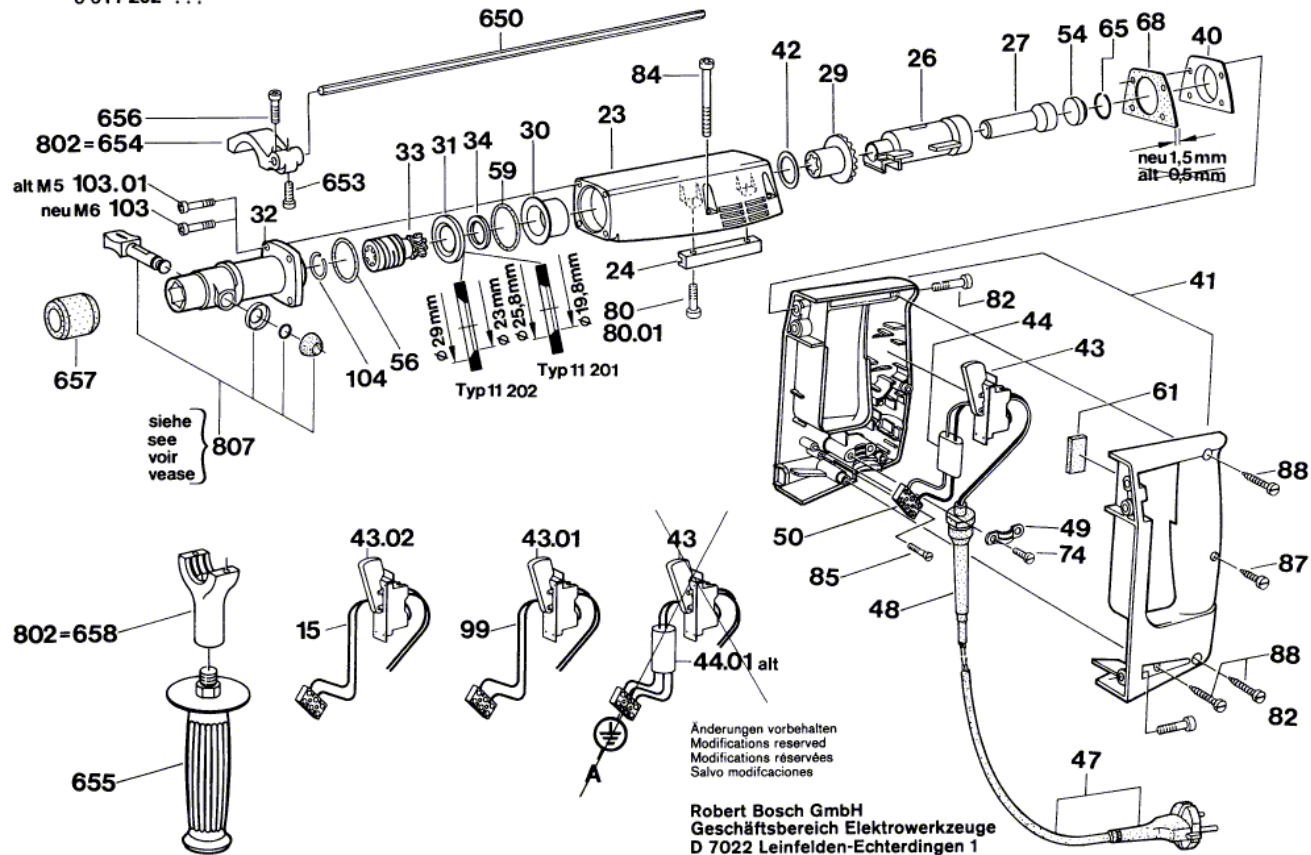

Illustration - Type - E

EW - EVW 2 / 302 / 4 X (12.76

Typ 0 611 201 ...
0 611 202 ...

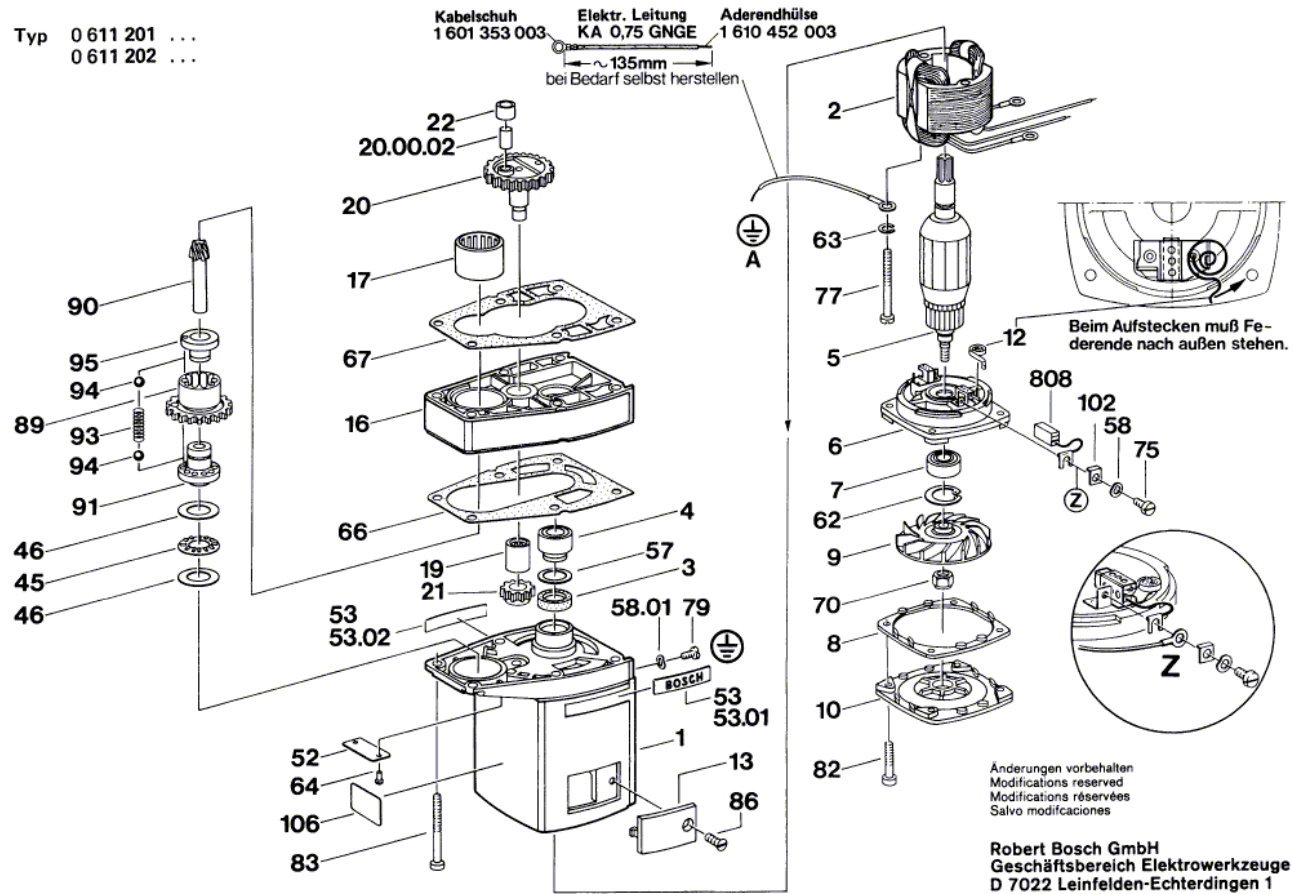
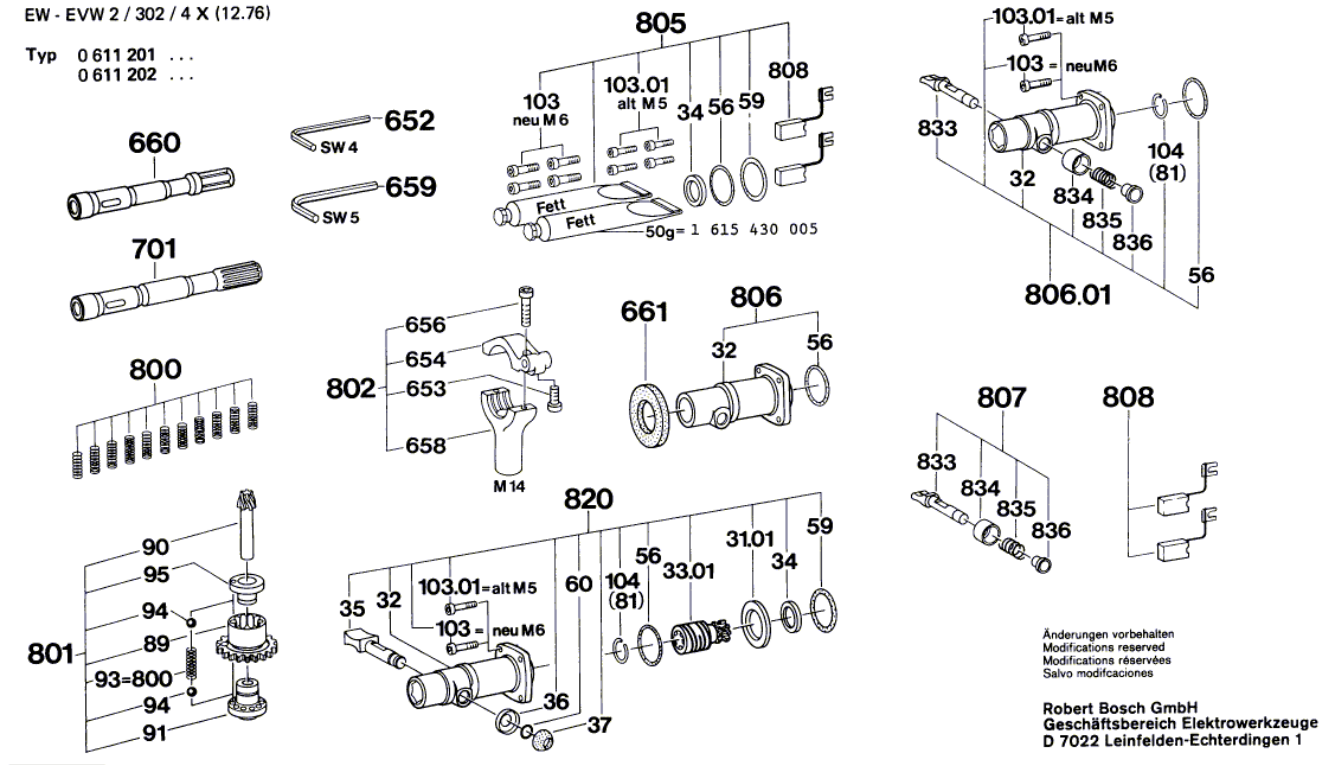

Illustration - Type - E

EW - EVW 2 / 302 / 4 X (12.76)

Typ 0 611 201 ...
0 611 202 ...



Änderungen vorbehalten
Modifications reserved
Modifications réservées
Salvo modificaciones

Robert Bosch GmbH
Geschäftsbereich Elektrowerkzeuge
D 7022 Leinfelden-Echterdingen 1