

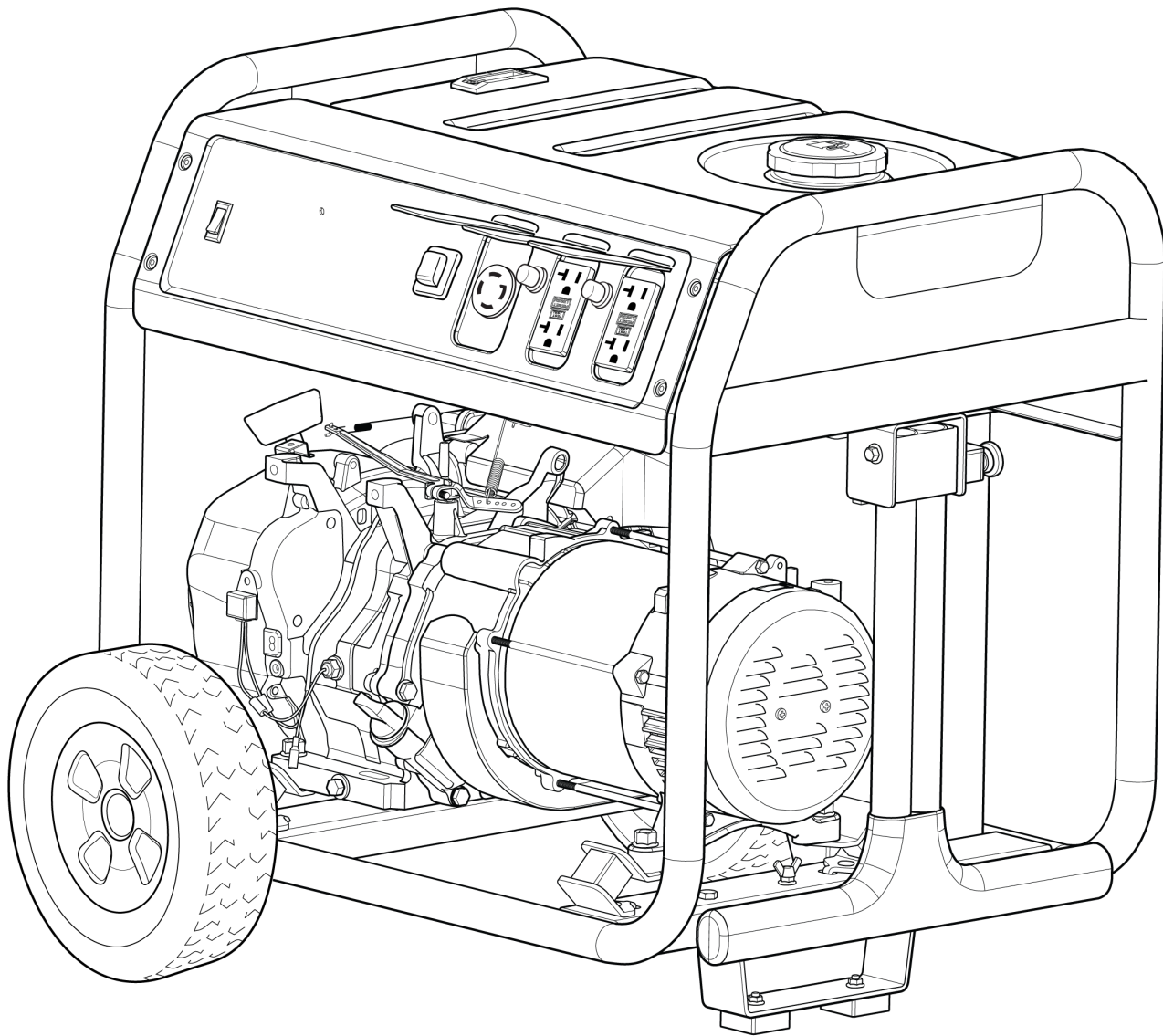

Parts Manual

Mfg. No: 030744-03
5,500 Watt Briggs & Stratton 50 State



Control Panel

Note: Unless noted otherwise, use the standard torque specifications

Mfg. No: 030744-03

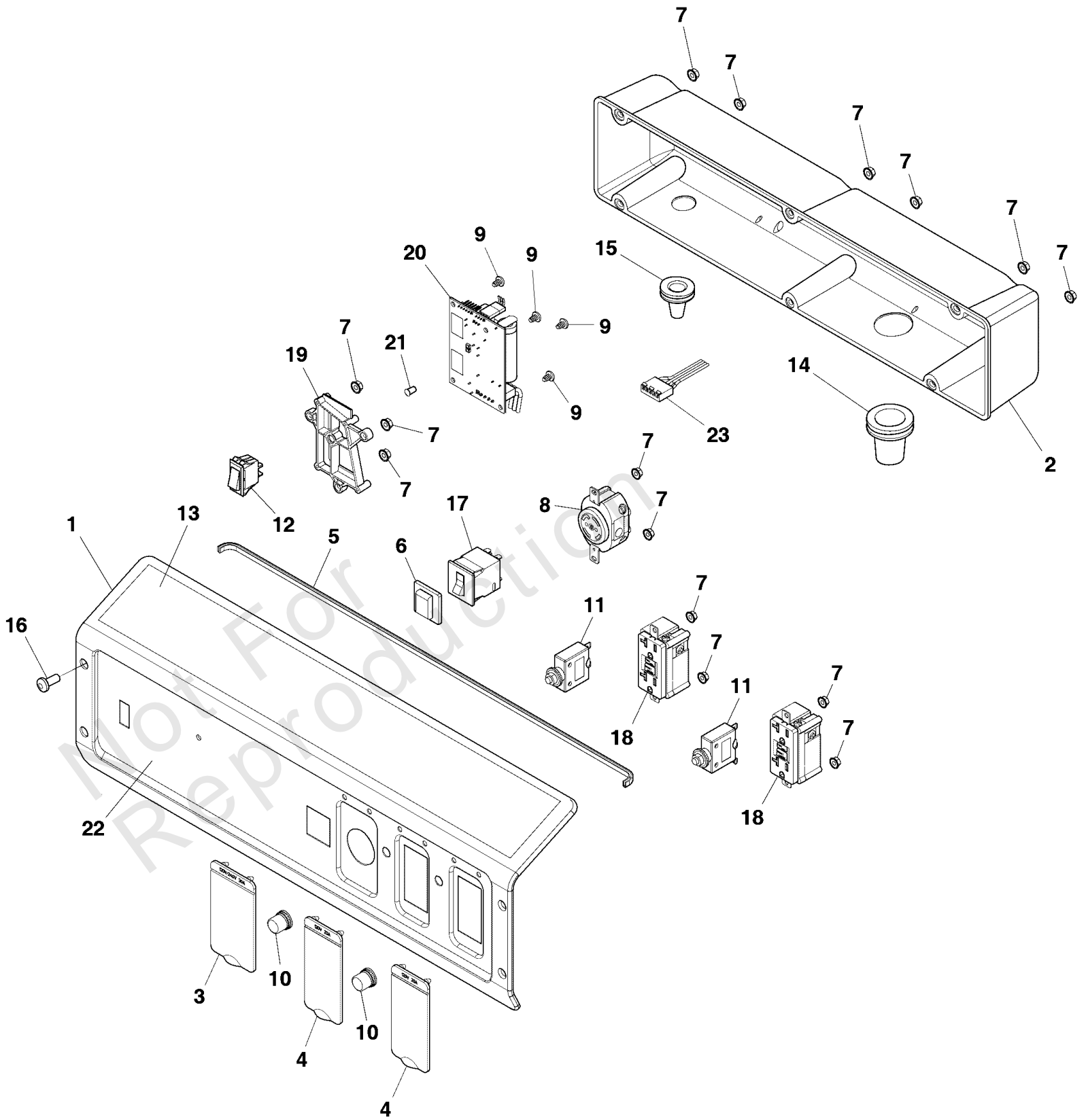

Control Panel

REF NO	PART NO	QTY	DESCRIPTION
1	84002297	1	PANEL-CONTROL -(Includes Items 13 & 22)
2	84002288	1	BOX-CONTROL PANEL
3	319477GS	1	COVER-OUTLET
4	319476GS	2	COVER-OUTLET
5	319459GS	1	TRIM-EDGE
6	191481GS	1	BOOT, Breaker Circuit
7	795016	15	NUT
8	43437GS	1	OUTLET-120/240V TL30A
9	84001102	4	SCREW
10	312636GS	2	BOOT, Circuit Breaker
11	704907	2	BREAKER-CIRCUIT 20A
12	319525GS	1	SWITCH-ON/OFF
13	772212	1	DECAL
14	319529GS	1	GROMMET
15	319530GS	1	GROMMET
16	703804	4	SCREW
17	84002298	1	BREAKER-CIRCUIT
18	709526	2	OUTLET
19	772213	1	BRACKET-MODULE
20	84005519	1	MODULE-CO
21	772217	1	LIGHT-PIPE
22	84002296	1	DECAL
23	772215	1	WIRE-HARNESS-CO

Main Unit

Note: Unless noted otherwise, use the standard torque specifications

Mfg. No: 030744-03

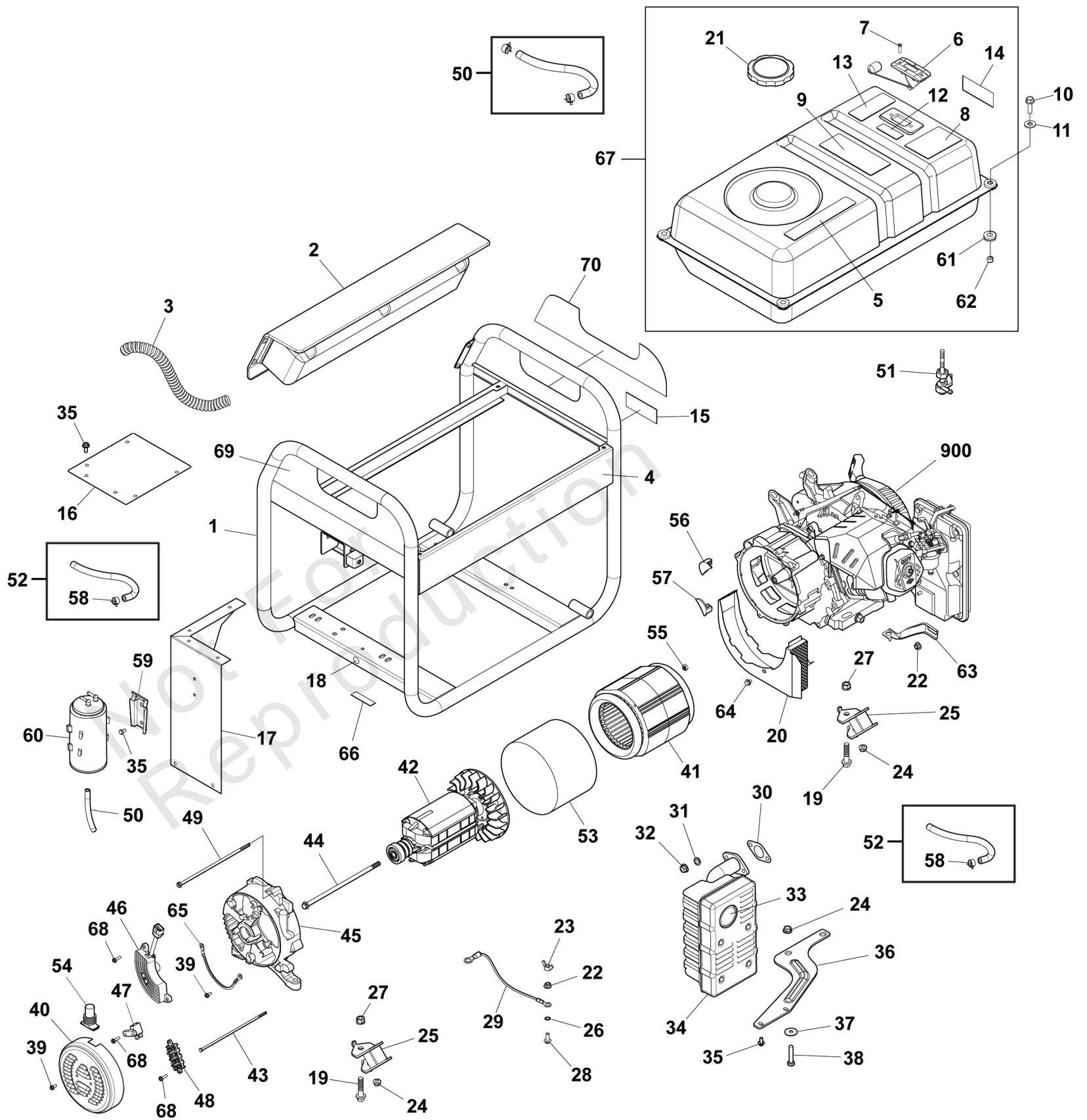

Main Unit

REF NO	PART NO	QTY	DESCRIPTION
1	84002246	1	CRADLE -(Includes Items 4, 15 & 18)
2	REF - 80098057	1	Refer to: Control Panel Group
3	707433	1	SLEEVE
4	772231	1	DECAL
5	772237	1	DECAL
6	704183	1	GAUGE-FUEL
7	314440GS	2	SCREW
8	202997GS	1	DECAL, Warning, CO
9	772212	1	DECAL
10	703805	4	SCREW
11	312005GS	4	WASHER
12	703264	1	DECAL
13	772233	1	DECAL
14	84001097	1	DECAL
15	772236	1	DECAL
16	319456GS	1	HEATSHIELD
17	708881	1	HEATSHIELD
18	704331	1	DECAL
19	709939	1	BOLT
20	709941	1	COVER-ALT
21	319587GS	1	CAP-FUEL
22	52857GS	1	NUT-M6 FLANGE
23	87680GS	1	NUT
24	67989GS	4	NUT, M8 Flange Serrated
25	708877	4	MOUNT-VIBRATION
26	26850GS	1	WASHER, Ext. M6 - 1/4" Shakeproof
27	709938	4	NUT
28	706355	1	SCREW
29	709932	1	WIRE
30	704853	1	GASKET
31	703454	2	LOCKWASHER, Spring, 3/8
32	45771GS	2	NUT, M8 - 1.25
33	83083GS	1	SCREEN
34	708878	1	MUFFLER
35	706152	1	SCREW
36	708879	1	BRACKET-MUFFLER
37	B2495GS	3	WSHR, 25.4 X 8.45 X 1.4
38	709934	3	BOLT
39	709935	2	SCREW
40	704838	1	END COVER
41	707429	1	STATOR
42	707432	1	ROTOR
43	707298	4	BOLT
44	707296	1	BOLT
45	704836	1	CARRIER-BEARING
46	704913	1	VOLTAGE REGULATOR
47	704915	1	BRUSH ASSY
48	705783	1	TERMINAL BLOCK

Footnotes:

Note:* (Verify your specific engine model, reference the ID Tag located on your engine.) (Refer to your local Briggs & Stratton distributor for parts and service.)

Main Unit

REF NO	PART NO	QTY	DESCRIPTION
49	707297	2	BOLT
50	791745	1	LINE, Fuel -(Cut to Fit)
51	209417GS	1	VALVE-FUEL
52	315017GS	1	HOSE-VAPOR -(Cut to Fit)
53	707295	1	BAND-STATOR
54	207879GS	1	BOOT
55	709931	1	NUT
56	705771	1	GUARD-RUBBER
57	705772	1	GUARD-RUBBER
58	314955GS	1	CLAMP
59	318884GS	1	BRACKET
60	709684	1	CARBON CANISTER
61	189134GS	4	GROMMET, Rubber
62	189137GS	4	SPACER
63	708880	1	BRACKET-AIR CLEANER
64	84002244	1	SCREW-FLANGE M6
65	709940	1	WIRE
66	706535	1	PAD-RUBBER
67	84002253	1	TANK-FUEL
68	84001685	2	BOLT
69	84002256	1	DECAL
70	84002254	1	DECAL
900	24G032-0008-G1		*Engine -*(Refer to Note:)

Footnotes:

Note:* (Verify your specific engine model, reference the ID Tag located on your engine.) (Refer to your local Briggs & Stratton distributor for parts and service.)

Wheel Kit (80006254)

Note: Unless noted otherwise, use the standard torque specifications

Mfg. No: 030744-03

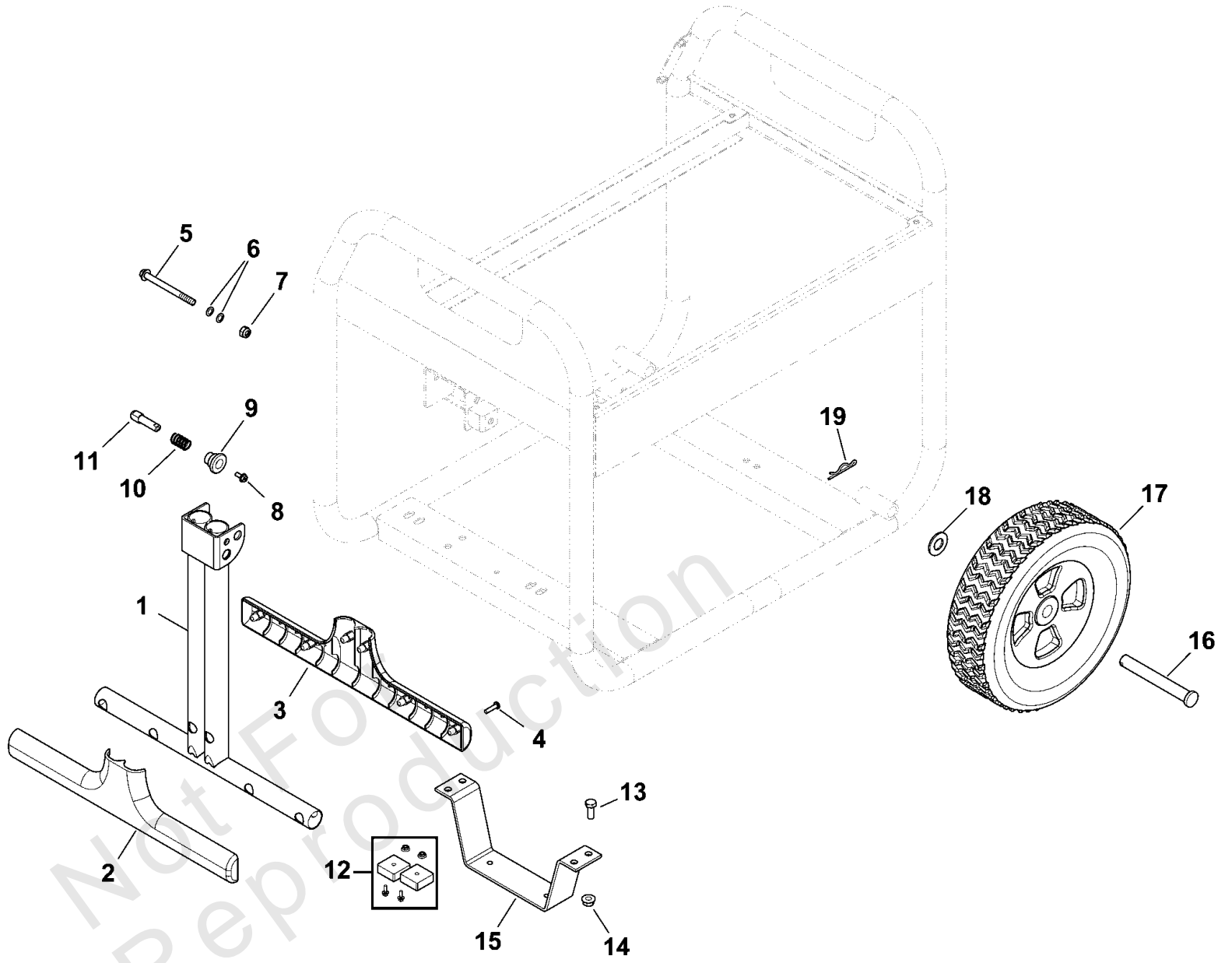

Wheel Kit (80006254)

REF NO	PART NO	QTY	DESCRIPTION
1	319396GS	1	HANDLE
2	319360GS	1	GRIP-HANDLE
3	319361GS	1	GRIP-HANDLE
4	75477GS	6	SCREW
5	318677GS	1	BOLT
6	84002245	2	WASHER
7	49820GS	1	NUT
8	84001685	1	BOLT
9	319453GS	1	KNOB
10	319452GS	1	SPRING
11	319454GS	1	PIN
12	319285GS	1	MOUNT-VIBRATION
13	771804	4	BOLT
14	67989GS	4	NUT
15	704198	1	SUPPORT-LEG
16	703813	2	AXLE
17	704145	2	WHEEL
18	22247GS	2	WASHER
19	316510GS	2	PIN-HAIR

Not For Reproduction

